

Warehouse Use Only

Part #	QUANTITY
D070	1
D109	1
G308	4
H34W	4
A613-42W	2
BG534	2
A02	1
A06	1
A69	1

Part #:	H1093W
Dimensions:	8" X 8" X 43" (Telescopic)
Weight:	???

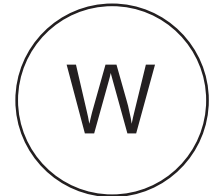

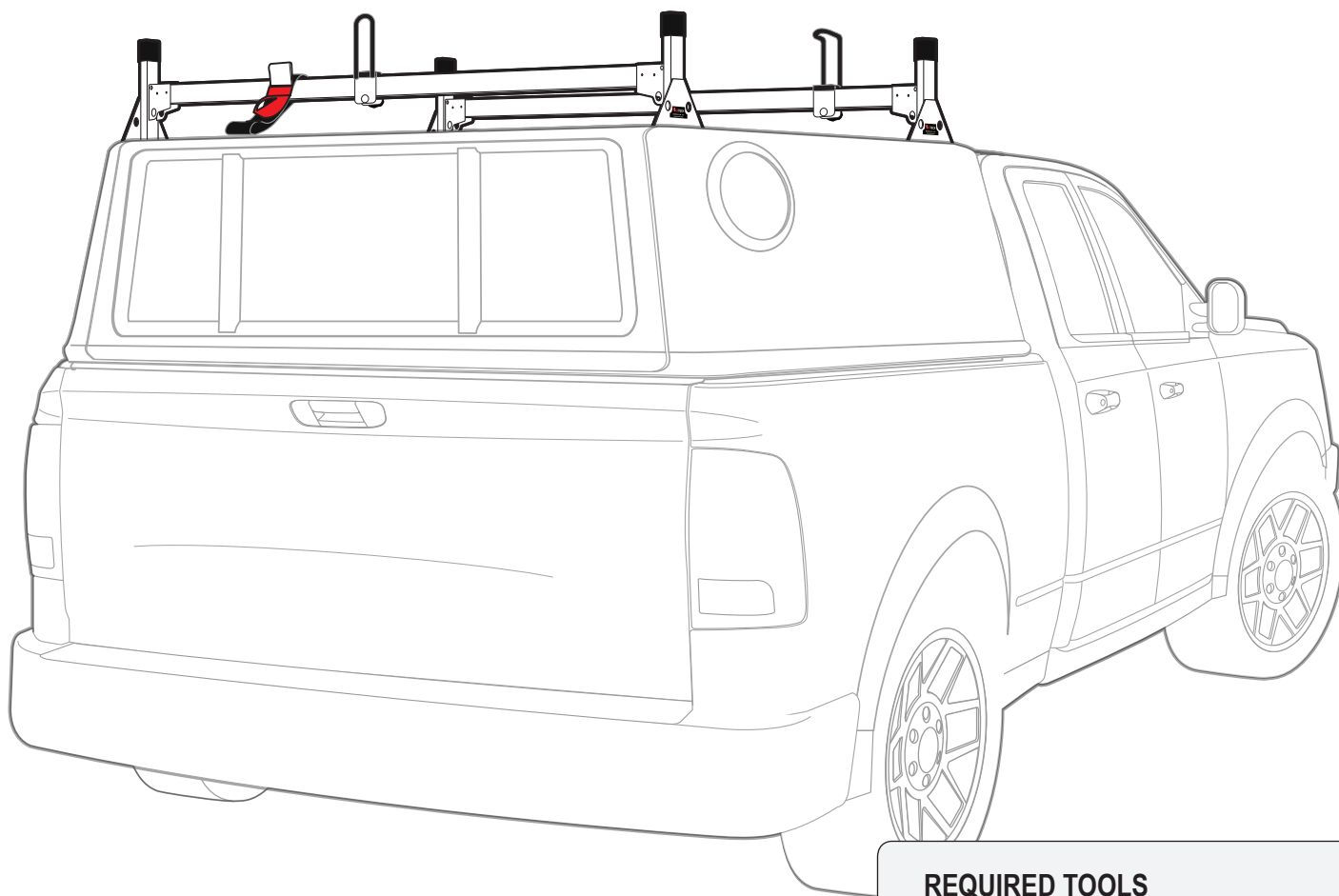

PRODUCT INFO

Part #: H1093W
System: H1 Series
Material: Aluminum
Fitment: Universal (Drilling Required)
Color: White

REQUIRED TOOLS

Power Tool With Phillips Head

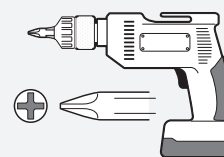

Power Tool With 5/16" Drill Bit

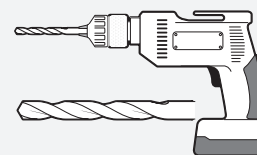



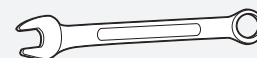





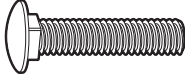
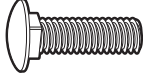
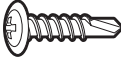

1/2" Wrench

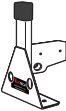

Marker



PART #	DESCRIPTION	QTY	ITEM ITEM NOT DRAWN TO SCALE
W008	5/16" X 3/4" WASHER	8	
B018	1 3/4" X 5/16" CARRIAGE BOLT	2	
B016	1 1/4" X 5/16" CARRIAGE BOLT	8	
B201	TAP SCREW	8	
N005	5/16" NYLON NUT	8	
N016	5/16" PLASTIC KNOB	2	
M03	INTERIOR PLATE	4	
H34	H1 MOUNTING BASE	4	
A613-42	2" X 1" X 42" CROSS BAR	2	
G308	RUBBER GASKET 2" X 8"	4	
A02	LADDER GUIDE	1	
A06	LADDER STOPPER	1	
A69	EZ-VELCRO STRAP	1	
BG534	RUBBER BAR GUARD 34"	2	

RUBBER BAR GUARDS

- Press the rubber bar guard into the channels of cross bars
- Leave 4" on each end



EZ-Velcro Strap

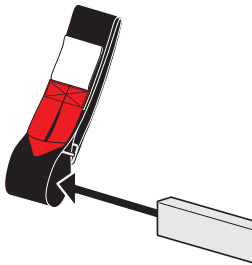

Directions

