

Warehouse Use Only

| Part # | QUANTITY |
|----------|----------|
| D020 | 1 |
| D111 | 1 |
| G308 | 4 |
| H33B | 4 |
| A500-42B | 2 |
| BG034 | 2 |
| A02 | 1 |
| A06 | 1 |
| A69 | 1 |

| | |
|-------------|----------------------------|
| Part #: | H1090B |
| Dimensions: | 8" X 8" X 43" (Telescopic) |
| Weight: | ??? |

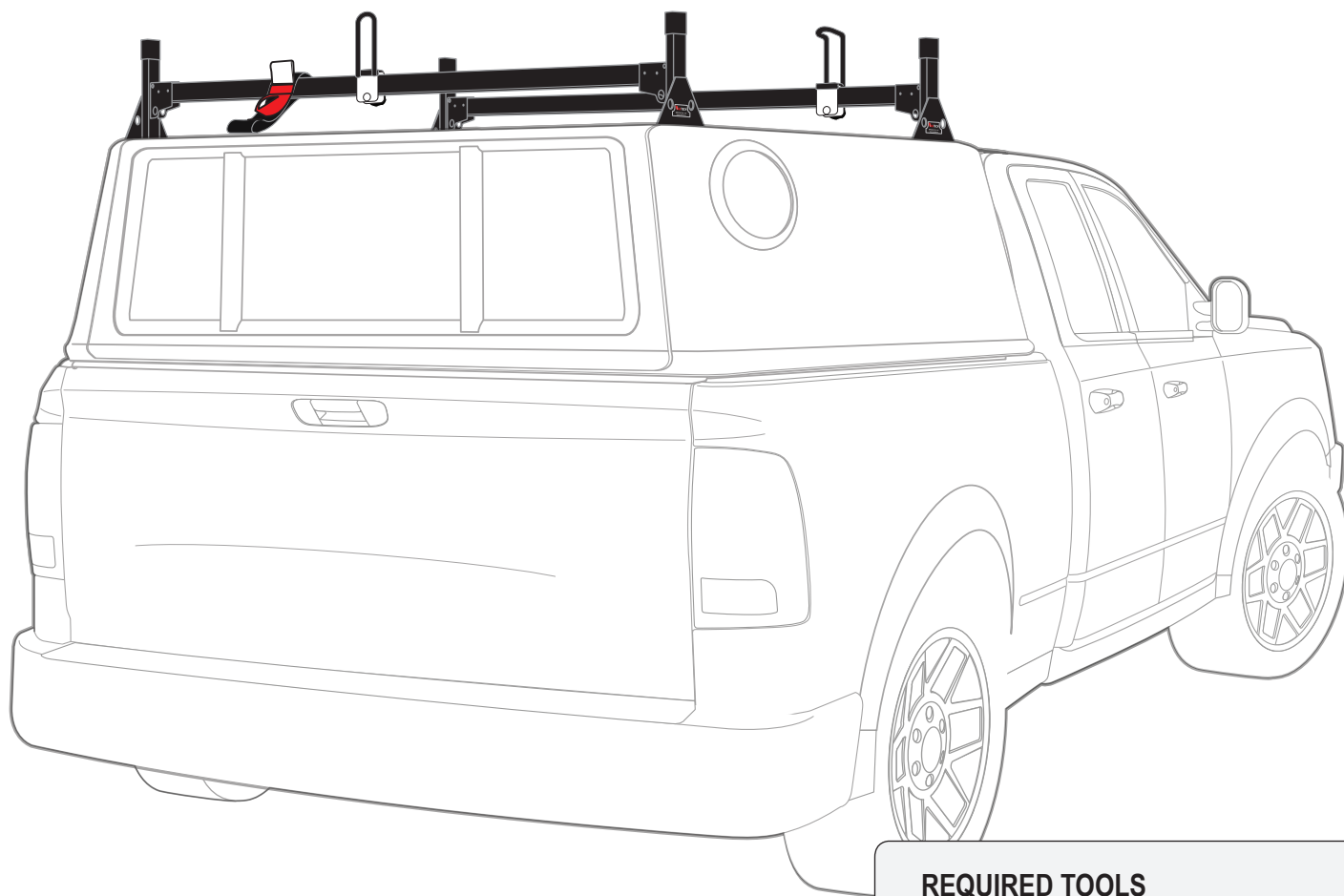



PRODUCT INFO

Part #: H1090B
System: H1 Series
Material: Steel
Fitment: Universal (Drilling Required)
Color: Black

REQUIRED TOOLS

Power Tool With Phillips Head

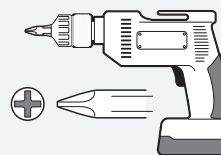

Power Tool With 5/16" Drill Bit

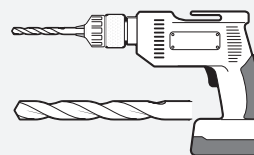





1/2" Wrench

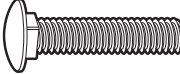
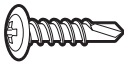

Marker



| PART # | DESCRIPTION | QTY | ITEM ITEM NOT DRAWN TO SCALE |
|---------|------------------------------|-----|---|
| W008 | 5/16" X 3/4" WASHER | 8 |  |
| B018 | 1 3/4" X 5/16" CARRIAGE BOLT | 2 |  |
| B016 | 1 1/4" X 5/16" CARRIAGE BOLT | 8 |  |
| B201 | TAP SCREW | 8 |  |
| N005 | 5/16" NYLON NUT | 8 |  |
| N016 | 5/16" PLASTIC KNOB | 2 |  |
| M03 | INTERIOR PLATE | 4 |  |
| H33 | H1 MOUNTING BASE | 4 |  |
| A500-42 | 2" X 1" X 42" CROSS BAR | 2 |  |
| G308 | RUBBER SEAT 2" X 8" | 4 |  |
| A02 | LADDER GUIDE | 1 |  |
| A06 | LADDER STOPPER | 1 |  |
| A69 | EZ-VELCRO STRAP | 1 |  |
| BG034 | PLASTIC BAR GUARD 34" | 2 |  |

PLASTIC BAR GUARDS FOR STEEL CROSS BARS

- Remove wax paper from plastic bar guard and adhere it to the top of the Cross Bar.

- Leave 4" on each end

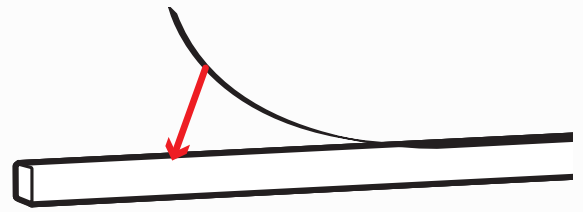
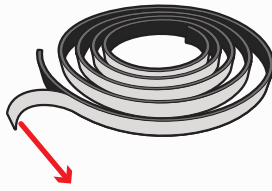

EZ-Velcro Strap

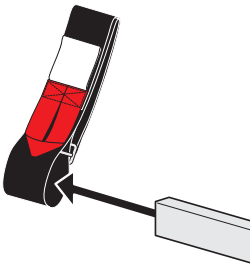

Directions

