



Warehouse Use Only

| Part # | QUANTITY |
|----------|----------|
| D012 | 1 |
| D112 | 1 |
| H11W | 6 |
| H04W | 6 |
| A500-62W | 1 |
| A500-63W | 2 |
| BG055 | 3 |
| BG908 | 6 |
| A02 | 2 |
| A06 | 2 |
| A69 | 2 |

| | |
|-------------|----------------------------|
| Part #: | H1063W |
| Dimensions: | 8" X 8" X 64" (Telescopic) |
| Weight: | ??? |



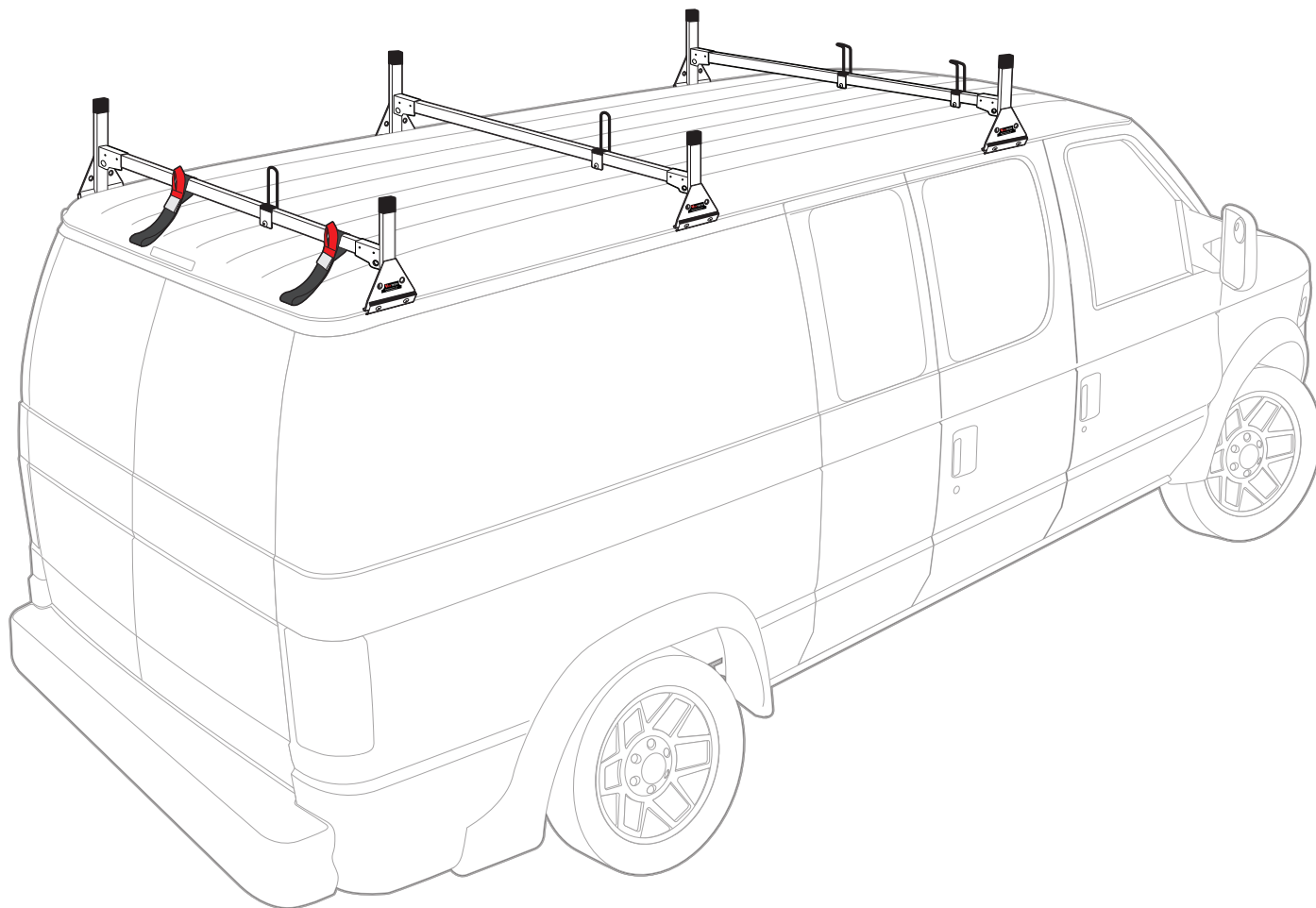

PRODUCT INFO

Part #: H1063W
System: H1 Series
Material: Steel
Fitment: Dodge Ram 1981-07
Color: White





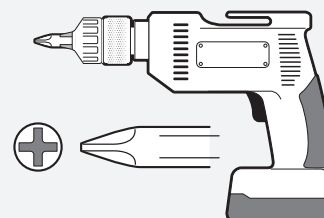





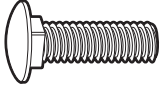
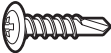

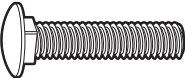
REQUIRED TOOLS

Power Tool With Phillips Head



1/2" Wrench

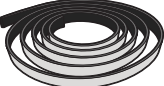

| PART # | DESCRIPTION | QTY | ITEM ITEM NOT DRAWN TO SCALE |
|---------|------------------------------|-----|---------------------------------------------------------------------------------------|
| B016 | 5/16" X 1 1/4" CARRIAGE BOLT | 12 |  |
| B201 | TAP SCREW | 12 |  |
| N005 | 5/16" NYLON NUT | 12 |  |
| W008 | 5/16" X 3/4" WASHER | 12 |  |
| B018 | 5/16" X 1 3/4" CARRIAGE BOLT | 4 |  |
| N016 | 5/16" KNOB | 4 |  |
| H04 | H1 MOUNTING BASE (STANDARD) | 6 |  |
| A500-62 | 2" X 1" X 62" CROSS BAR | 1 |  |
| A500-63 | 2" X 1" X 63" CROSS BAR | 2 |  |
| H11 | 2" X 8" DRIP RAIL CLAMP | 6 |  |
| A02 | LADDER GUIDE | 2 |  |
| A06 | LADDER STOPPER | 2 |  |
| A69 | EZ-VELCRO STRAP | 2 |  |
| BG055 | PLASTIC BAR GUARD 55" | 3 |  |
| BG908 | RUBBER SEAT | 6 |  |

EZ-Velcro Strap

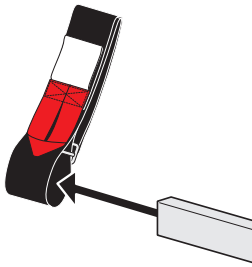

Directions

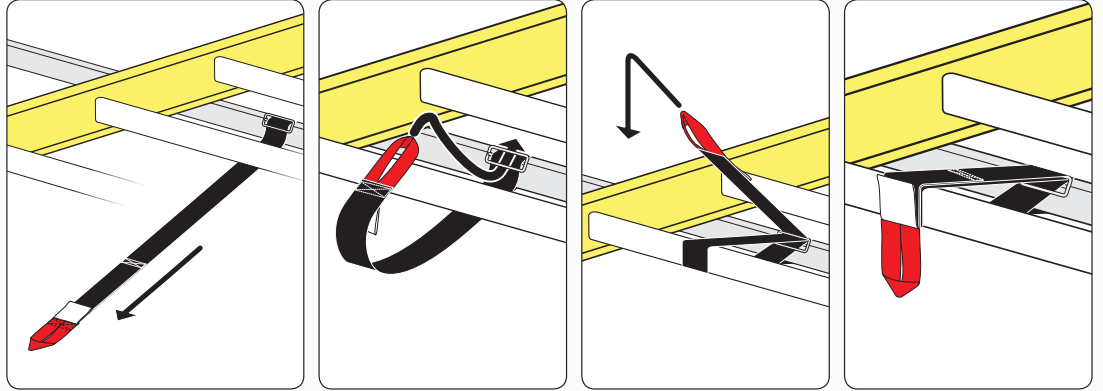

PLASTIC BAR GUARDS FOR STEEL CROSS BARS

- Remove wax paper from plastic bar guard and adhere it to the top of the Cross Bar.

- Leave 4" on each end

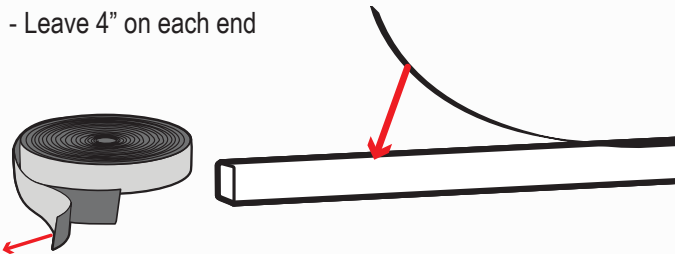

RUBBER SEATS FOR UPRIGHT MOUNTS

- Slide the Rubber Seats onto the bottom of the Upright Mounts.

- These prevent metal on metal contact for vehicles without a protective layer on their drip rail.

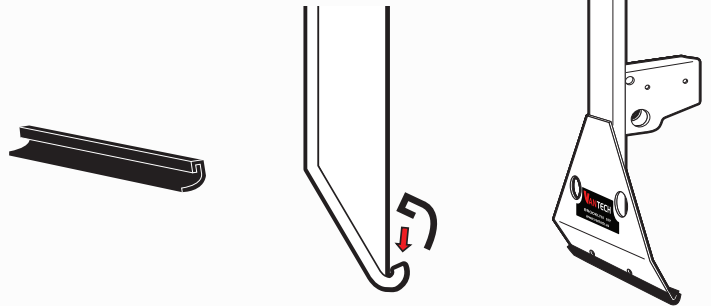

SYSTEM PLACEMENT MUST BE PLACED IN THIS ORDER

