



Warehouse Use Only

Part #	QUANTITY
D012	1
D112	1
H11B	6
H04B	6
A500-62B	1
A500-63B	2
BG055	3
BG908	6
A02	2
A06	2
A69	2

Part #:	H1063B
Dimensions:	8" X 8" X 64" (Telescopic)
Weight:	???



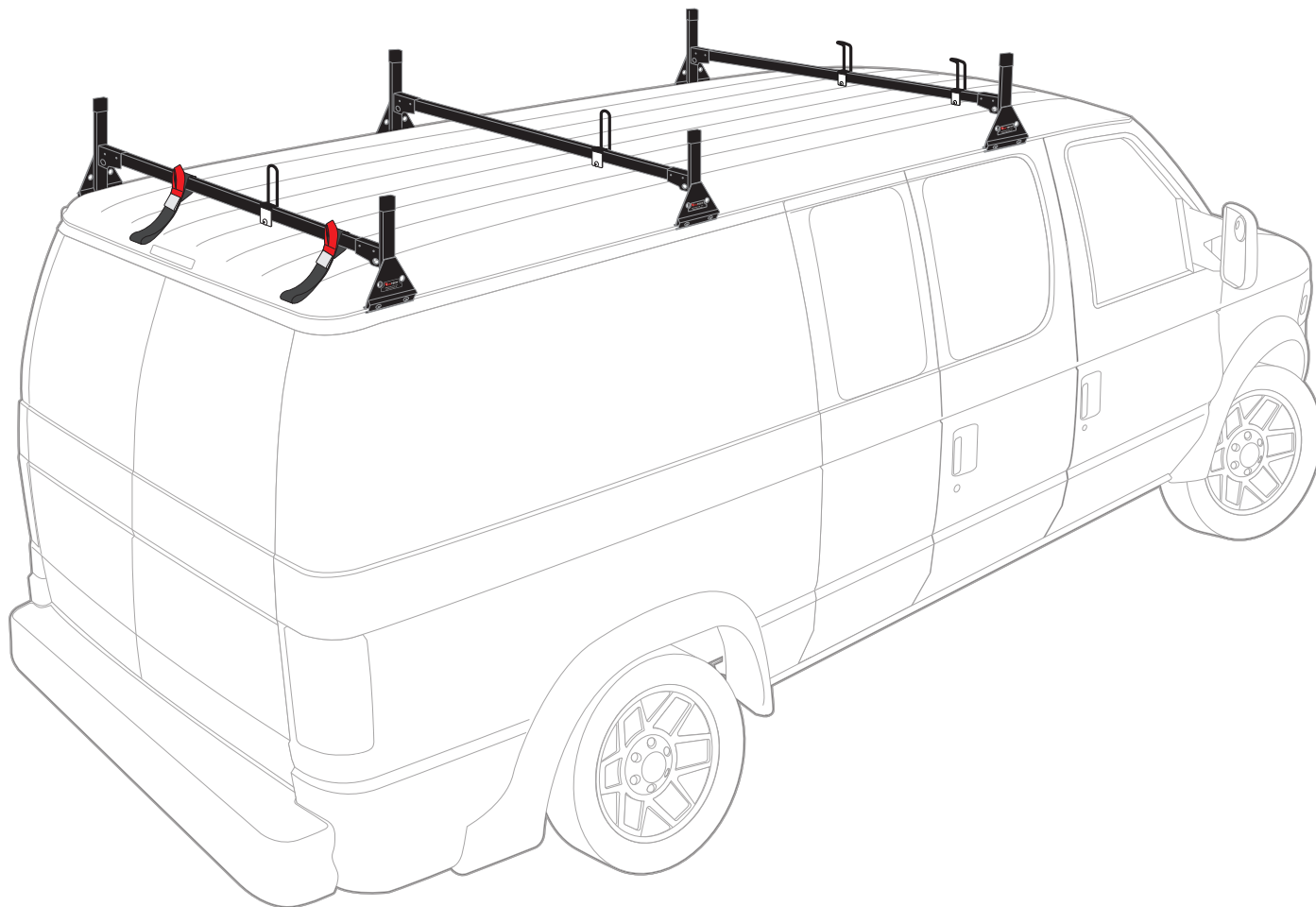

PRODUCT INFO

Part #: H1063B
System: H1 Series
Material: Steel
Fitment: Dodge Ram 1981-07
Color: Black





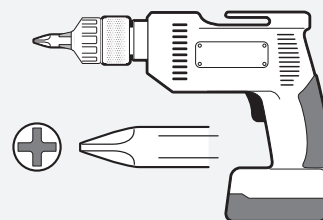





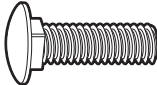

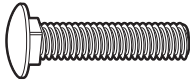

REQUIRED TOOLS

Power Tool With Phillips Head



1/2" Wrench



PART #	DESCRIPTION	QTY	ITEM ITEM NOT DRAWN TO SCALE
B016	5/16" X 1 1/4" CARRIAGE BOLT	12	
B201	TAP SCREW	12	
N005	5/16" NYLON NUT	12	
W008	5/16" X 3/4" WASHER	12	
B018	5/16" X 1 3/4" CARRIAGE BOLT	4	
N016	5/16" KNOB	4	
H04	H1 MOUNTING BASE (STANDARD)	6	
A500-62	2" X 1" X 62" CROSS BAR	1	
A500-63	2" X 1" X 63" CROSS BAR	2	
H11	2" X 8" DRIP RAIL CLAMP	6	
A02	LADDER GUIDE	2	
A06	LADDER STOPPER	2	
A69	EZ-VELCRO STRAP	2	
BG055	PLASTIC BAR GUARD 55"	3	
BG908	RUBBER SEAT	6	

EZ-Velcro Strap

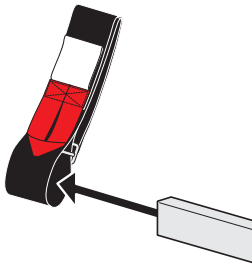

Directions

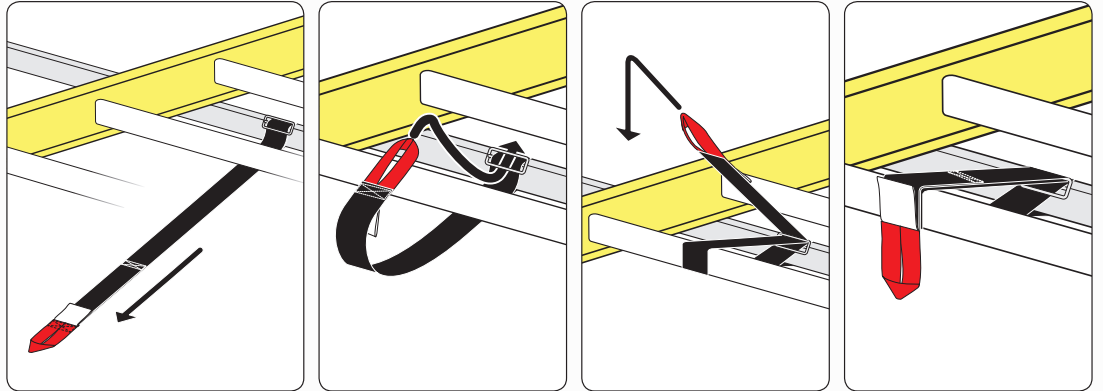

PLASTIC BAR GUARDS FOR STEEL CROSS BARS

- Remove wax paper from plastic bar guard and adhere it to the top of the Cross Bar.

- Leave 4" on each end

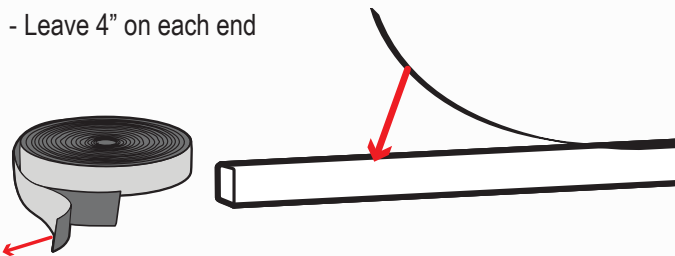

RUBBER SEATS FOR UPRIGHT MOUNTS

- Slide the Rubber Seats onto the bottom of the Upright Mounts.

- These prevent metal on metal contact for vehicles without a protective layer on their drip rail.

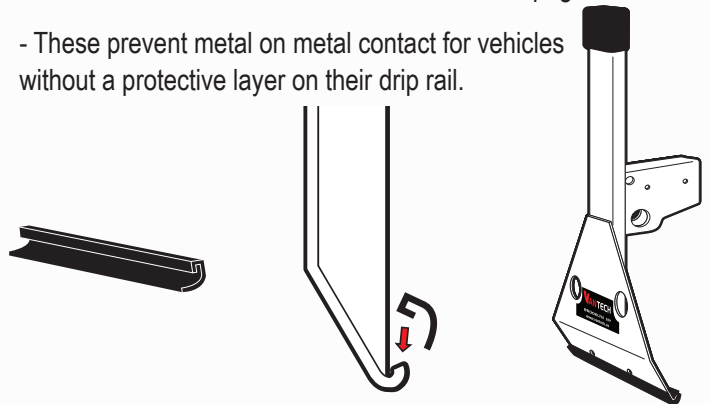

SYSTEM PLACEMENT MUST BE PLACED IN THIS ORDER

