



Warehouse Use Only

Part #	QUANTITY
D011	1
D111	1
H11B	4
H04B	4
A500-62B	1
A500-63B	1
BG055	2
BG908	4
A02	1
A06	1
A69	1

Part #:	H1062B
Dimensions:	8" X 8" X 64" (Telescopic)
Weight:	???



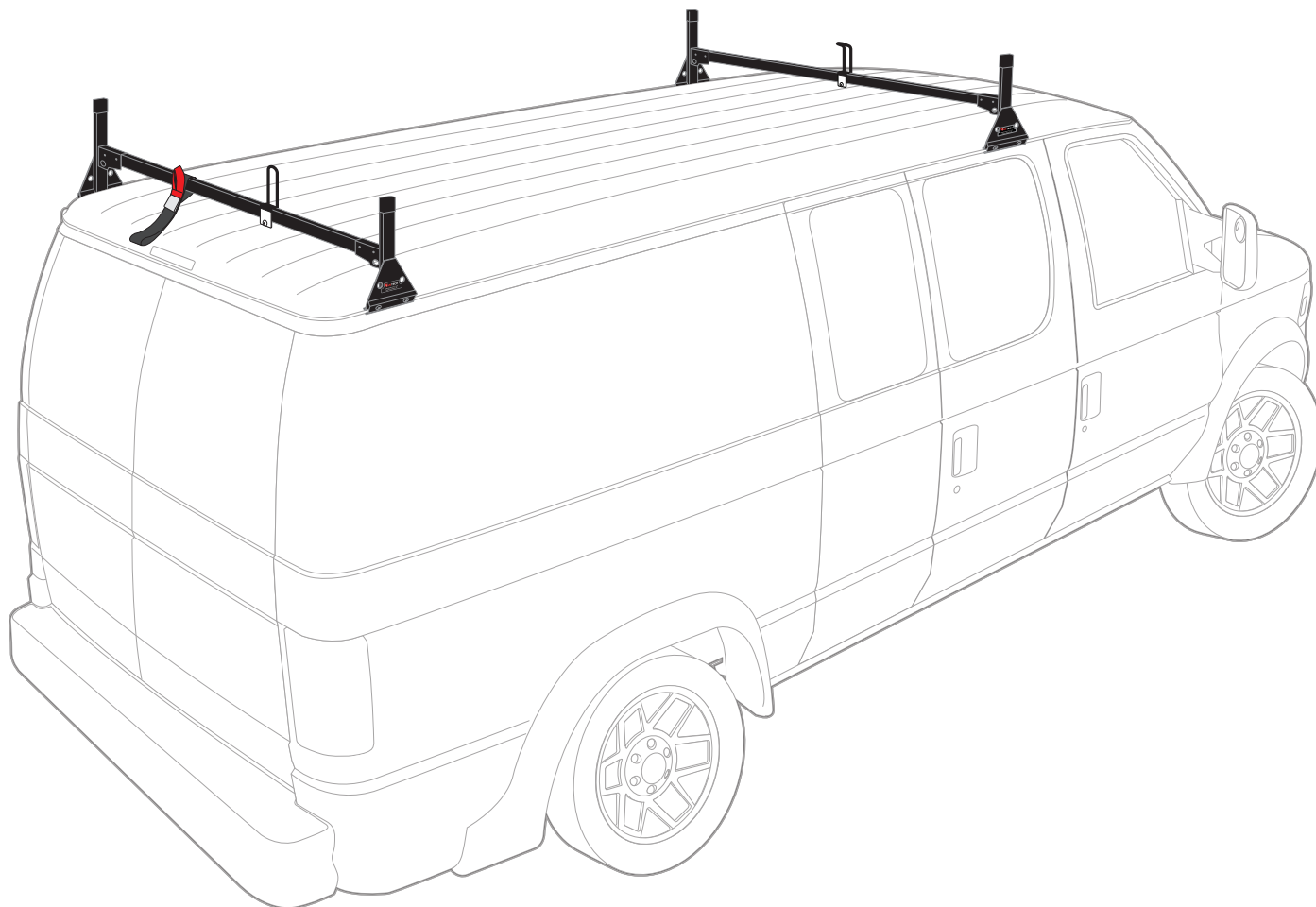

PRODUCT INFO

Part #: H1062B
System: H1 Series
Material: Steel
Fitment: Dodge Ram 1981-07
Color: Black





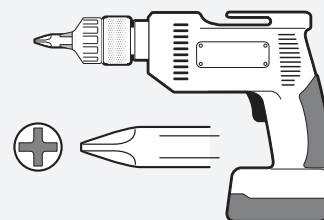





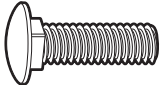

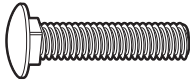

REQUIRED TOOLS

Power Tool With Phillips Head



1/2" Wrench



PART #	DESCRIPTION	QTY	ITEM ITEM NOT DRAWN TO SCALE
B016	5/16" X 1 1/4" CARRIAGE BOLT	8	
B201	TAP SCREW	8	
N005	5/16" NYLON NUT	8	
W008	5/16" X 3/4" WASHER	8	
B018	5/16" X 1 3/4" CARRIAGE BOLT	2	
N016	5/16" KNOB	2	
H04	H1 MOUNTING BASE (STANDARD)	4	
A500-62	2" X 1" X 62" CROSS BAR	1	
A500-63	2" X 1" X 63" CROSS BAR	1	
H11	2" X 8" DRIP RAIL CLAMP	4	
A02	LADDER GUIDE	1	
A06	LADDER STOPPER	1	
A69	EZ-VELCRO STRAP	1	
BG055	PLASTIC BAR GUARD 55"	2	
BG908	RUBBER SEAT	4	

EZ-Velcro Strap

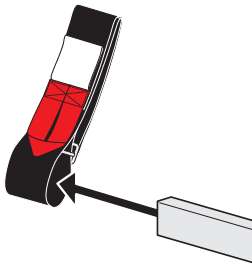

Directions

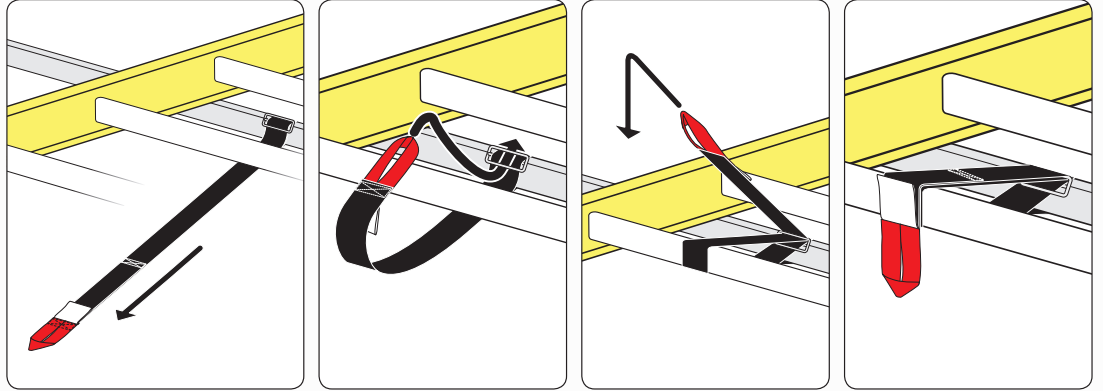

PLASTIC BAR GUARDS FOR STEEL CROSS BARS

- Remove wax paper from plastic bar guard and adhere it to the top of the Cross Bar.

- Leave 4" on each end

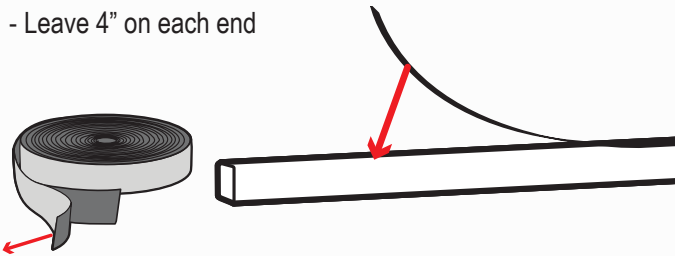

RUBBER SEATS FOR UPRIGHT MOUNTS

- Slide the Rubber Seats onto the bottom of the Upright Mounts.

- These prevent metal on metal contact for vehicles without a protective layer on their drip rail.

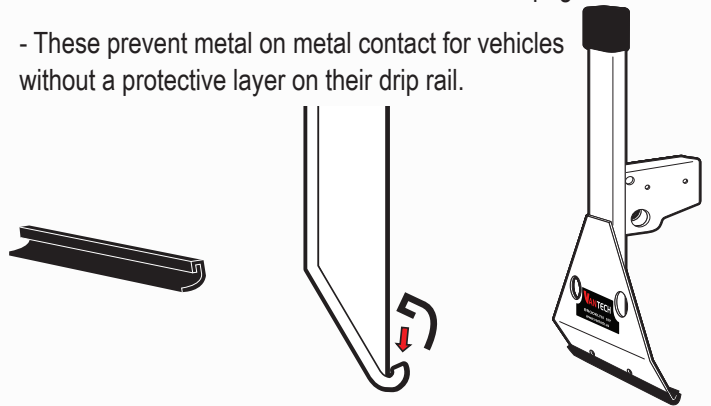

SYSTEM PLACEMENT MUST BE PLACED IN THIS ORDER

