



MODEL SPECIFIC GUIDE

Hidden Hinge Version

Model 4128 Toyota Tundra Std/Double Cab

6.5' Short Bed 2014-Current *(will fit with or without deckrail system)*

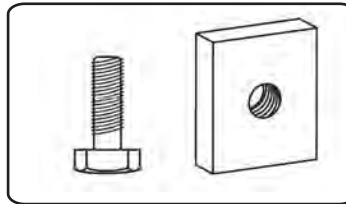

Deck Rail System Hardware

8 - 1" Bolts

8 - Square Nut Plates

Program Your Key

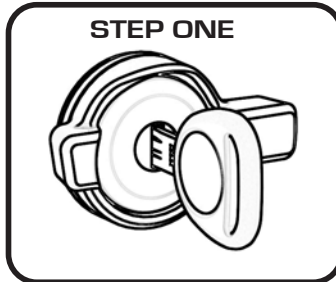
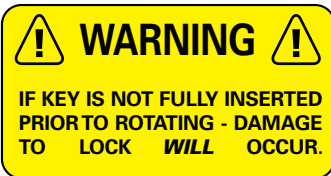

REMOVE LABEL, FULLY INSERT KEY

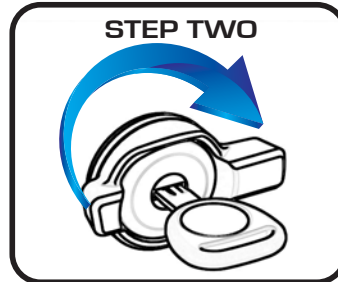

ROTATE CLOCKWISE 180 DEGREES

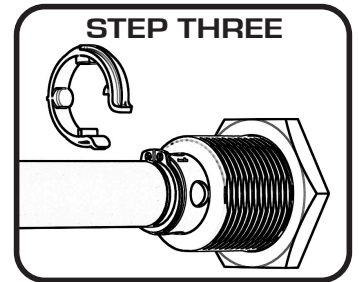

REMOVE PLASTIC CLIP BY PUSHING ON TABS. DISCARD CLIP.

RE: Step 2 on the Quick Start Guide

- If installing on truck with Deck Rail System follow instructions below.
- If installing on truck without Deck Rail System skip to measurement charts on reverse side.
- Remove the end caps from the Deck Rail System. Slide the tie down cleats towards the center of the Deck Rail. Slide the Square Nut Plates in place and position at rear of bed, install 1" bolts and washers according to diagram below and position the bracket according to the chart on reverse side.

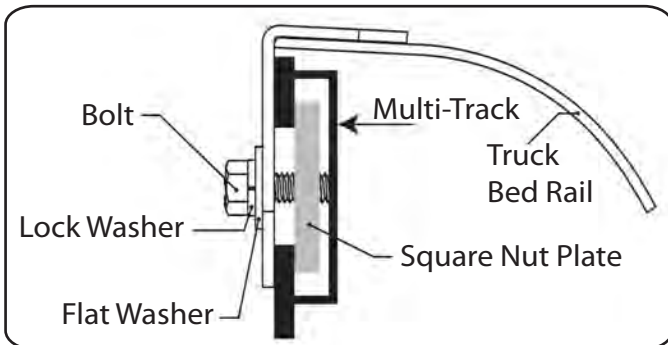

MODEL SPECIFIC GUIDE Hidden Hinge Version

Model 4128 Toyota Tundra 6.5' Short Bed

Continued - RE: Step 2 on the Quick Start Guide

Measurement for the rear mounting bracket is 51" from the back side of the bulkhead to the front edge of the bracket.

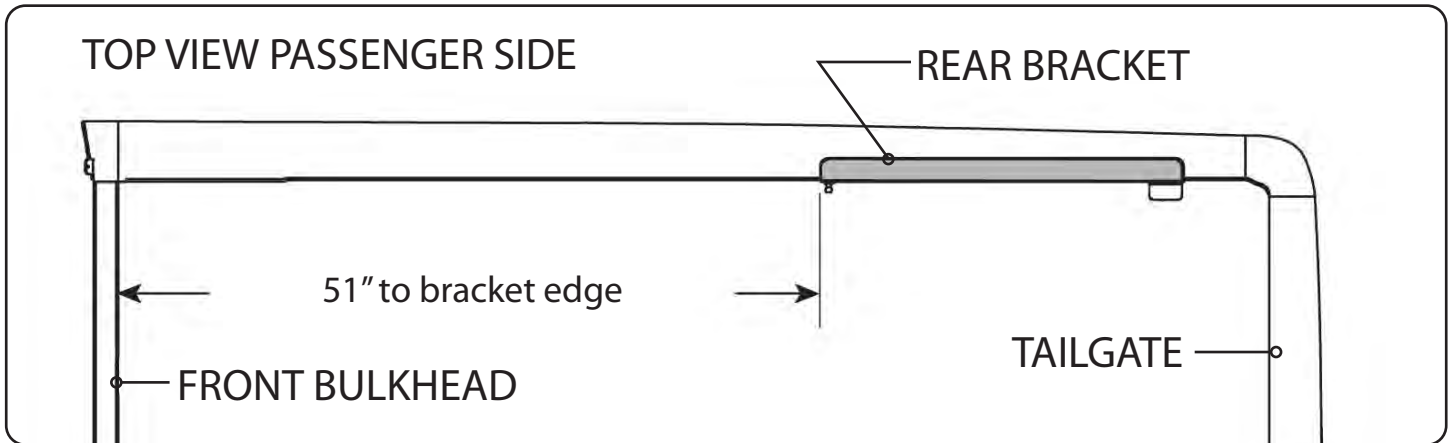

RE: Step 3 on the Quick Start Guide

Measurement for the front mounting bracket is 16 7/8" from the back side of the bulkhead to the end of the bracket.

The fit of the cover to the truck bed is determined by the front mounting brackets. This measurement is a good starting point. Unfortunately not all truck beds are assembled 100% square, so some adjustments may be necessary after the cover is set on the truck.

