



STEP BARS

TG-SS2F35058

BEFORE INSTALLATION

READ INSTRUCTIONS CAREFULLY BEFORE STARTING INSTALLATION. REMOVE CONTENTS FROM BOX AND VERIFY ALL PARTS ARE PRESENT. FAILURE TO IDENTIFY DAMAGE BEFORE INSTALLATION COULD LEAD TO A REJECTION OF ANY CLAIM. IF MISSING PARTS OR ANY DAMAGE FOUND, PLEASE TAKE A PICTURE FOR THE CLAIM PURPOSE.

TORQUE VALUES

Fastener Size	Class 8.8 Torque (ft-lbs)	Class 10.9 Torque (ft-lbs)
6mm	6-7	6-7
8mm	15-16	22-23
10mm	31-32	44-45
12mm	54-55	78-79
14mm	87-88	125-126

Parts List

- x1** Driver/Left Sidebar
- x1** Passenger/Right Sidebar
- x6** Mounting Brackets (left or right)
- x18** 8mm Plastic Isolator Washers
- x12** 8mm x 25mm Combo Bolts
- x18** 8mm x 24mm OD x 2mm Flat Washers
- x18** 8mm Nylon Lock Nuts

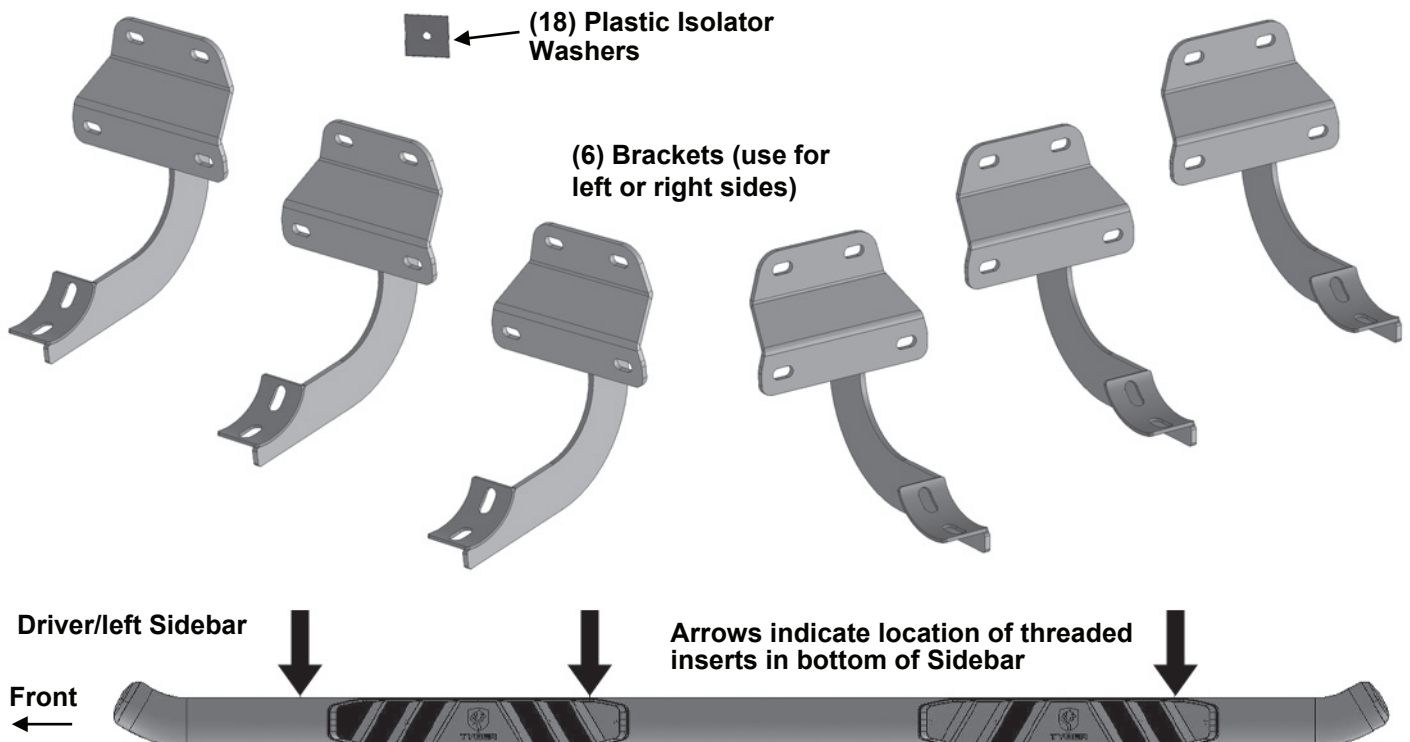



NOTE: REMOVE CONTENTS FROM BOX. VERIFY ALL PARTS ARE PRESENT. READ INSTRUCTIONS CAREFULLY. ASSISTANCE IS RECOMMENDED.

STEP 1

Start the installation under the driver/left side of the vehicle. Locate the front factory running board mounting location along the inner side of the body, (Fig 1). Use a wire brush or thread chaser die to remove excess paint and/or undercoating from all studs.

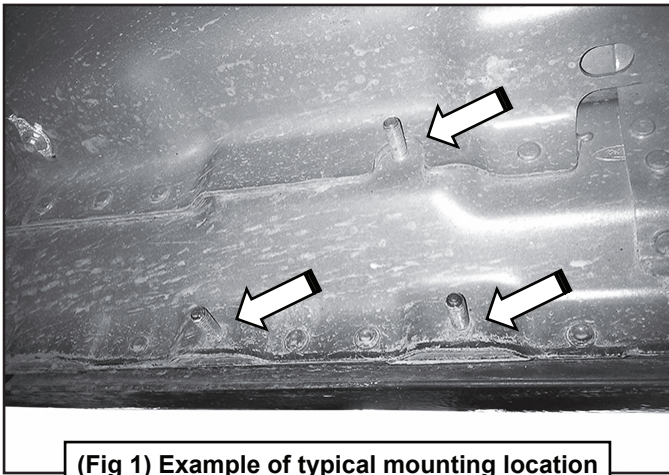

(Fig 1) Example of typical mounting location

STEP 2

Slide (1) Plastic Washer over each of the (3) factory mounting studs in the body panel, (Figs 2-4).

IMPORTANT: The Plastic Washers are designed to prevent corrosion between the aluminum body panel and the steel mounting brackets. Do not install the Brackets without the Plastic Washers.

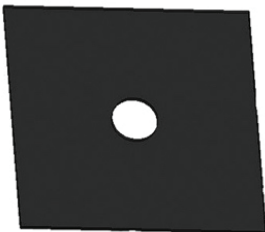

(Fig 2) Plastic Insulation Washer

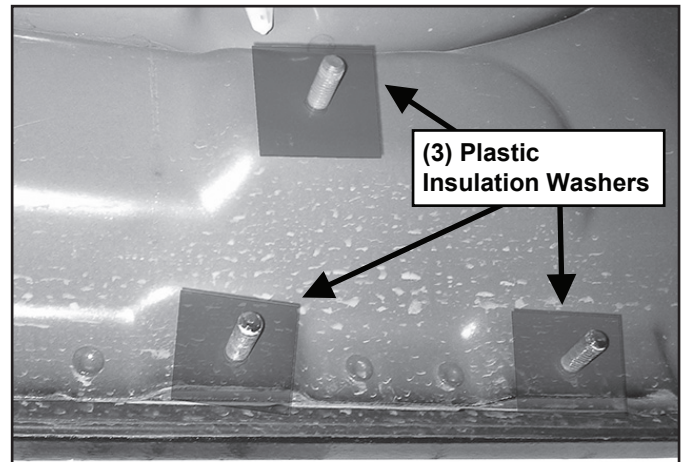

(Fig 3) Thread Plastic Washers onto all mounting studs

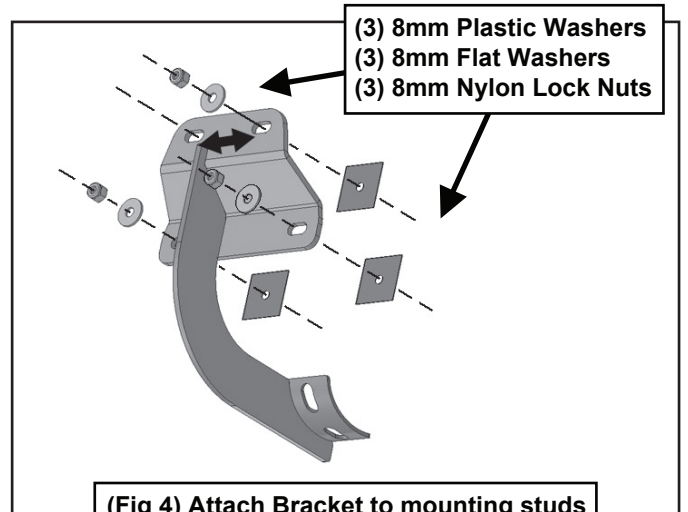

(Fig 4) Attach Bracket to mounting studs

STEP 3

Select (1) Bracket, (Fig 4).

NOTE: The Brackets are universal and can be installed in all locations. Attach the Bracket to the studs with (3) 8mm Flat Washers and (6) 8mm Nylon Lock Nuts, (Fig 4). Do not tighten hardware at this time.

STEP 4

Repeat Step 3 to install the center and rear Mounting Brackets.



STEP 5

Select the driver/left Sidebar. With assistance, carefully place the Sidebar onto the (3) Brackets. Do not slide or twist the Sidebar on the Brackets or it may become damaged.

STEP 6

Attach the Sidebar to the Brackets with the included (6) 8mm Combo Bolts, (Figs 5-8).

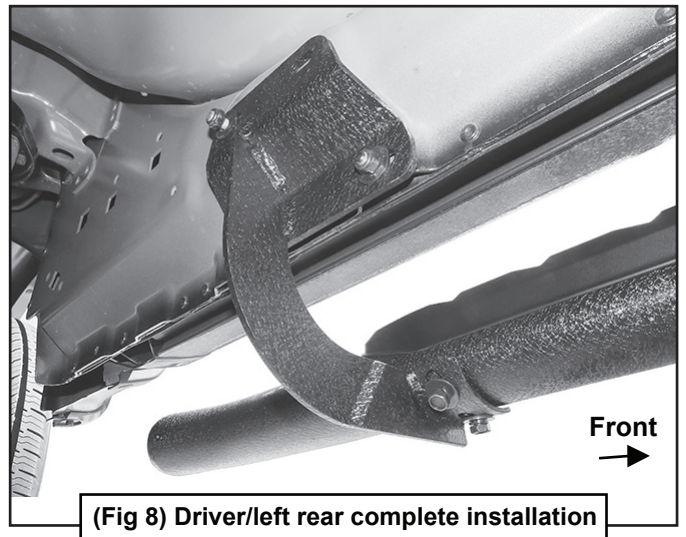
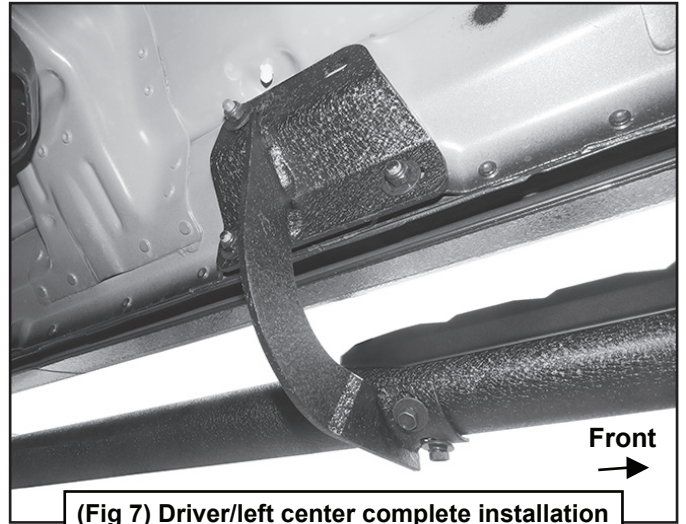
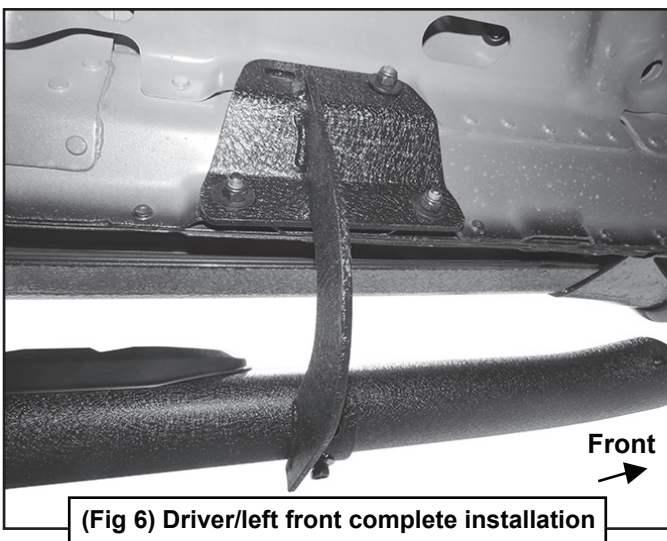
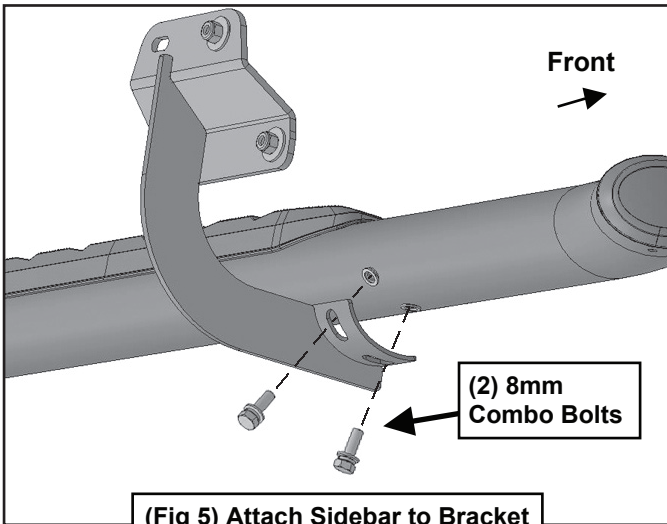

STEP 7

Level and adjust the Sidebar and tighten all hardware.

STEP 8

Repeat Steps 1-7 to install the passenger/right Sidebar assembly.



TYGER[®]

STEP 9

Do periodic inspections to the installation to make sure that all hardware is secure and tight.

