

Extra Adaptor Bar Needed

— for the bikes without top frame bar —



— Mountain Bike —



— City / Women Bike —

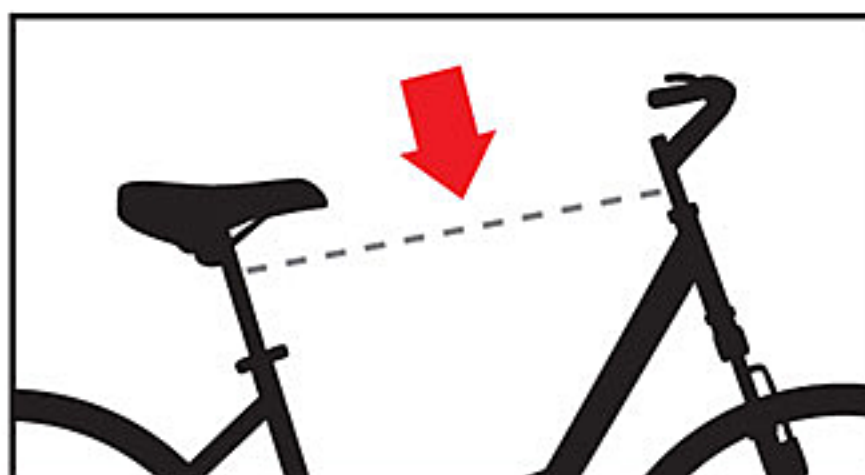
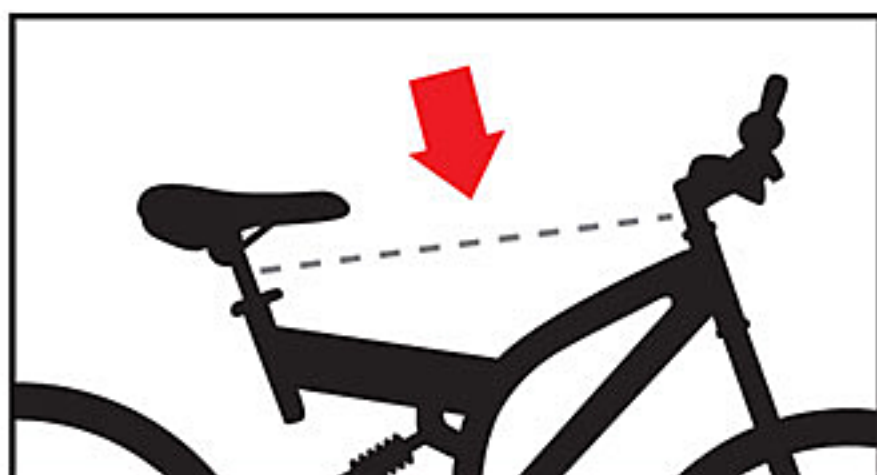

(You can find TYGER Adaptor Bar by searching with SKU# TG-RK1B108B.)



Easy operating safety pin allows tilt down feature (even with bikes loaded).

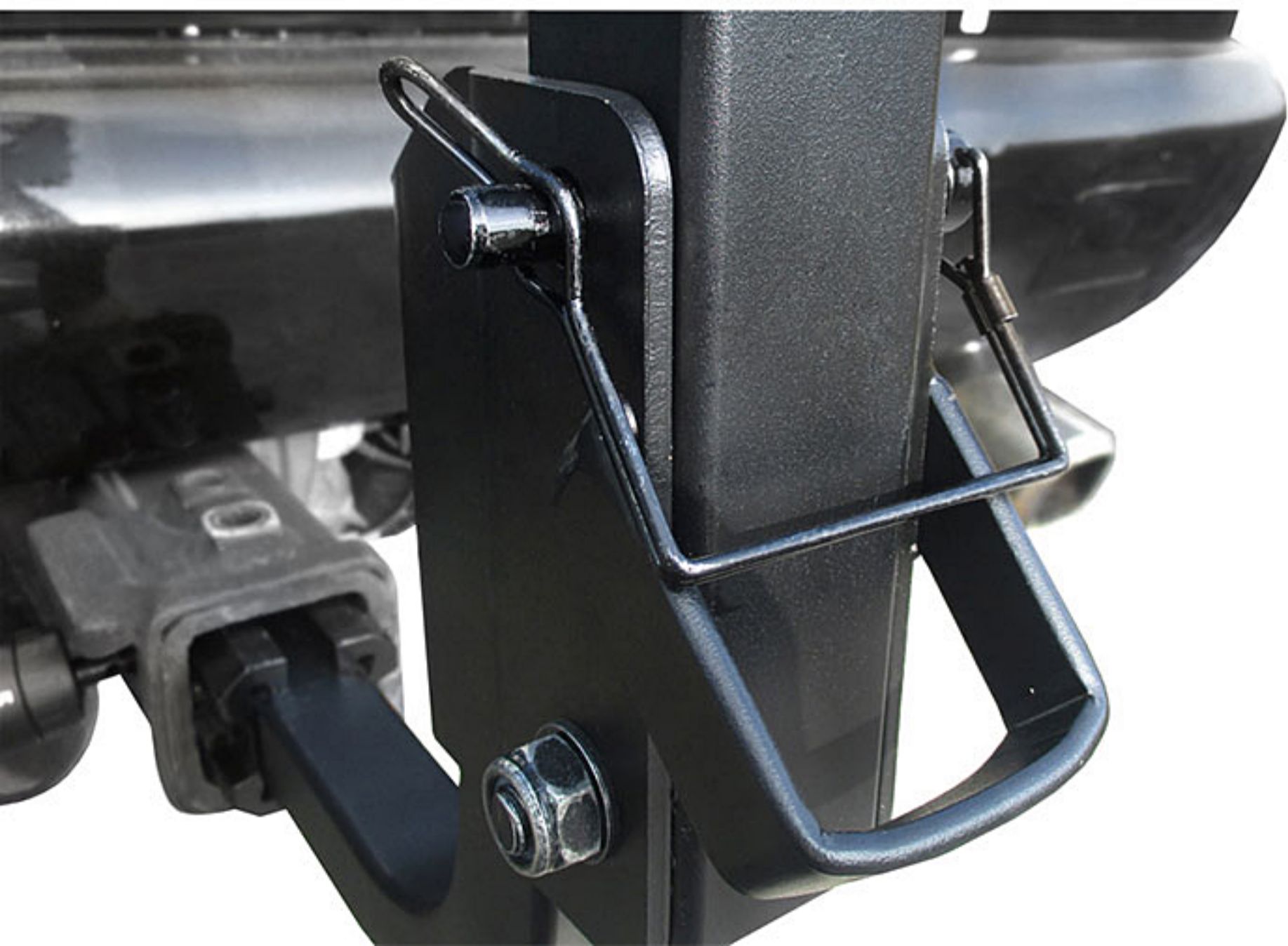

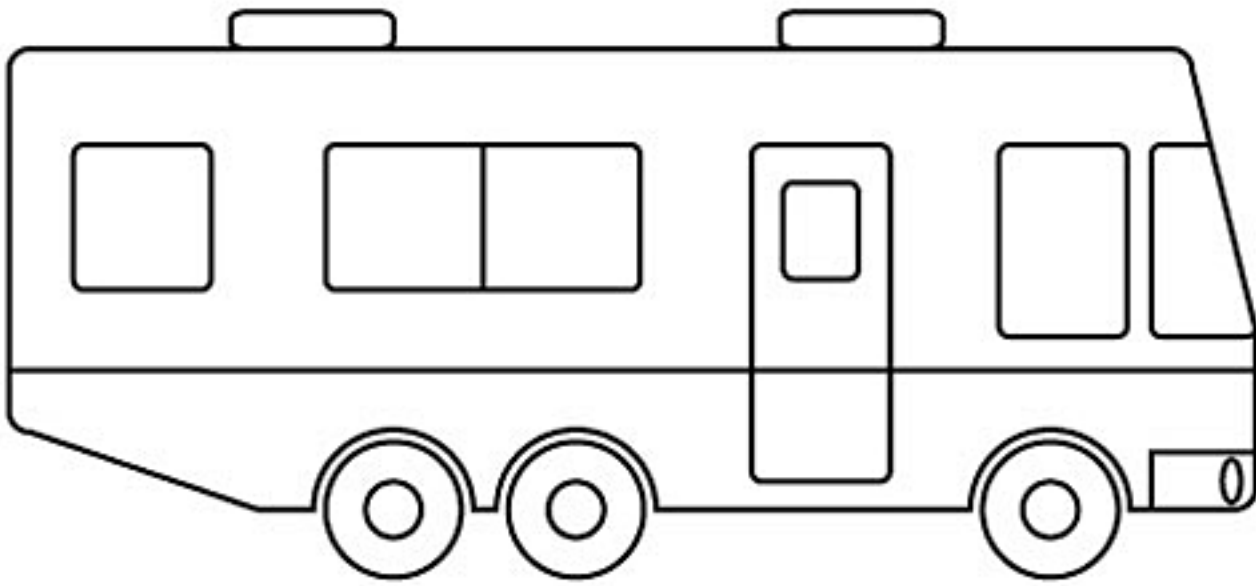

RV

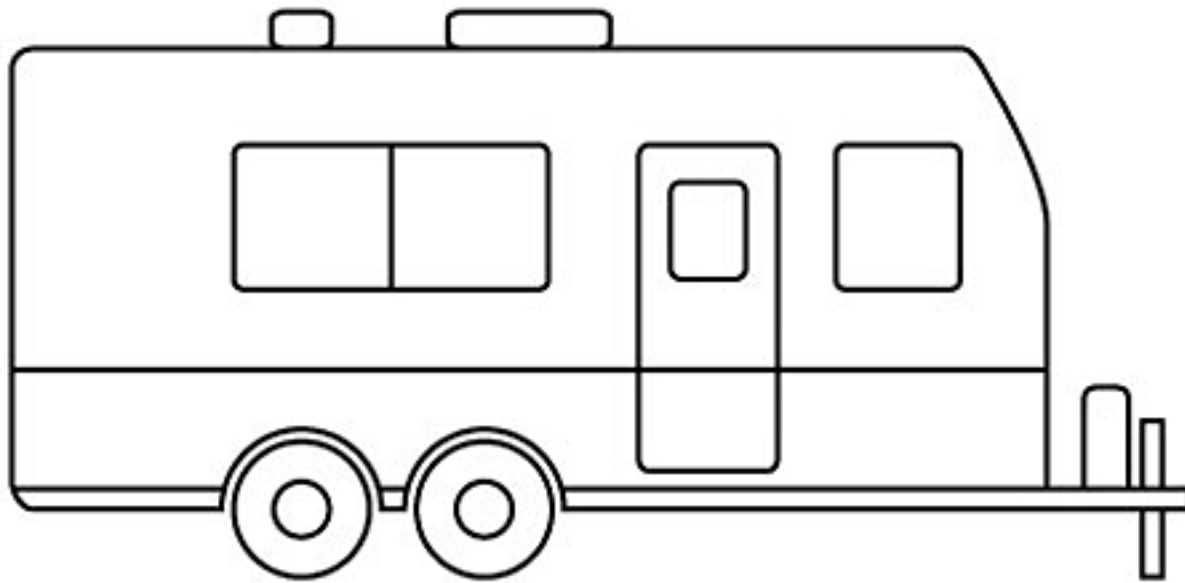

Trailer

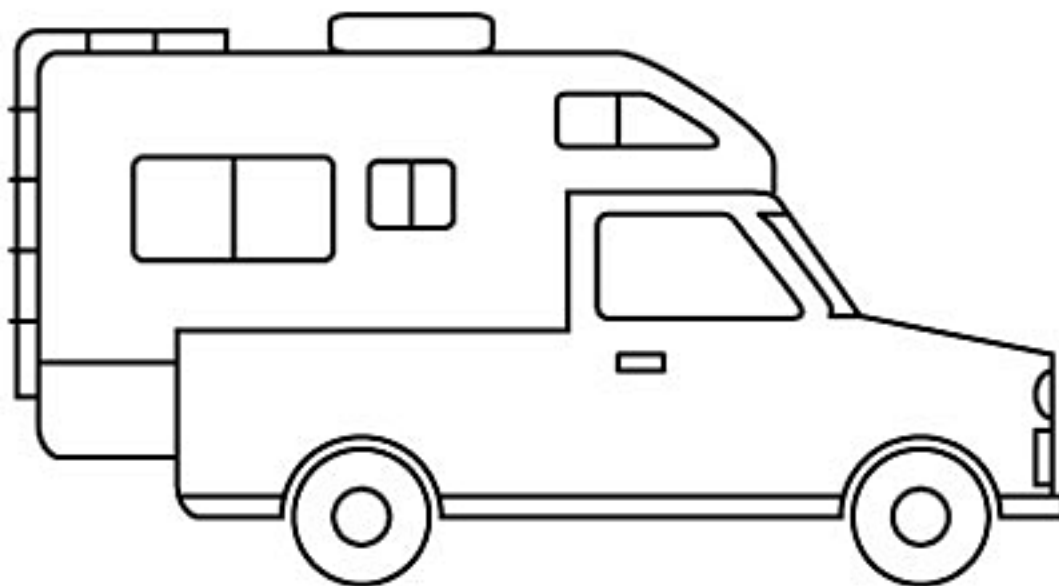

Camper



Do NOT install the bike carrier on trailers, campers, RVs or any vehicles longer than 18 feet.

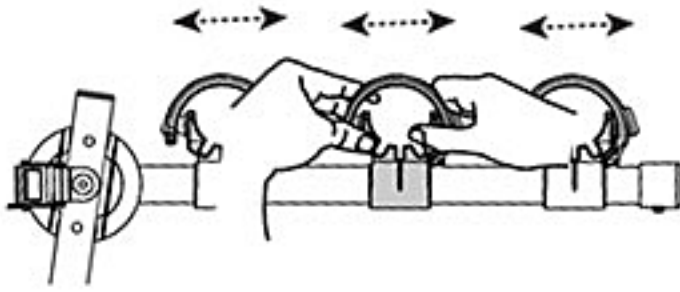

Cradle positions adjustable to accommodate for 3 bikes.



This rack can hold 3 city bikes or 2 mountain bikes plus 1 city bike. It can't hold 3 adult mountain bikes.

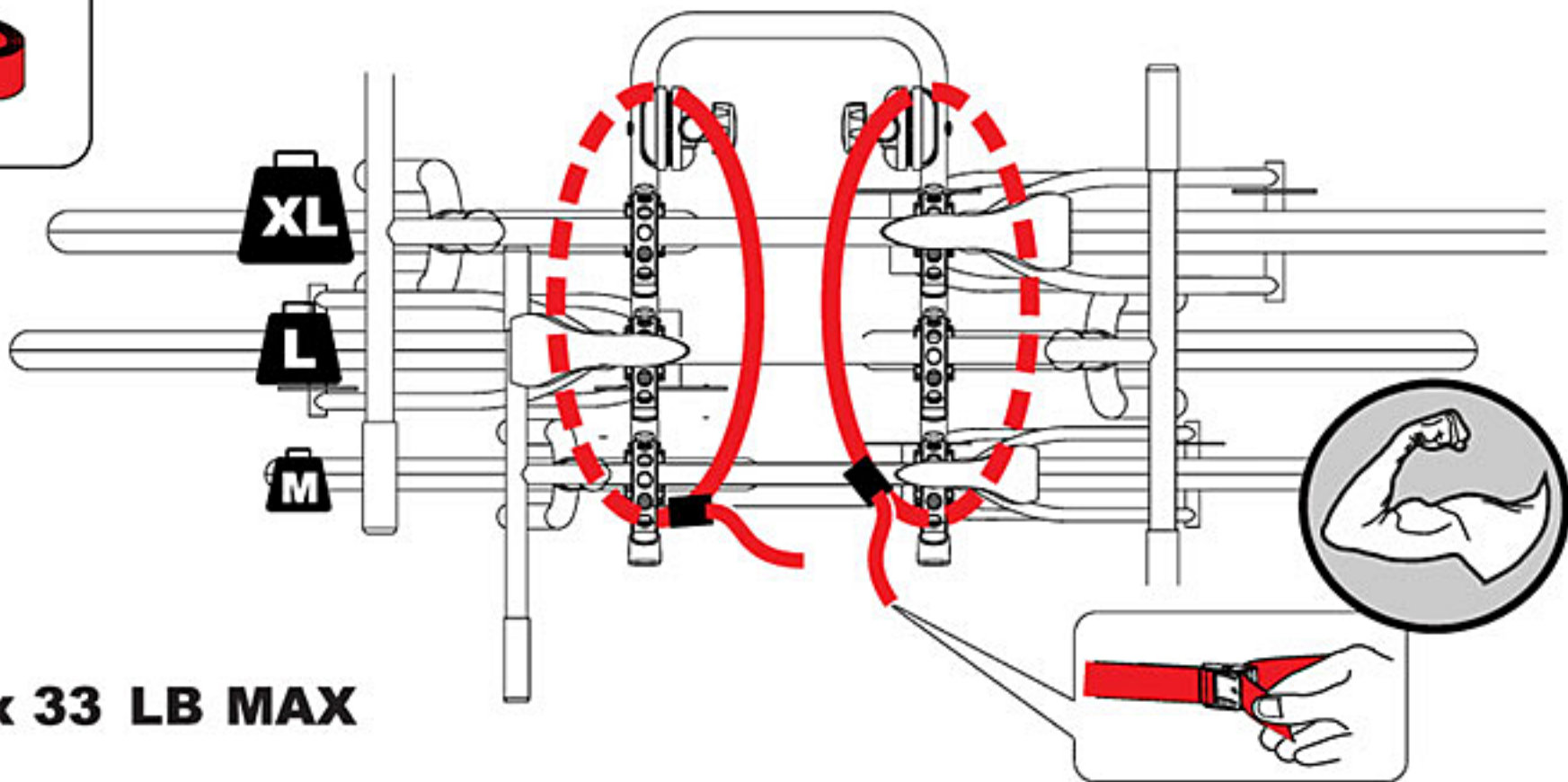
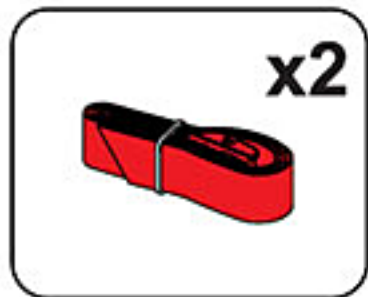

1 = 1x 33 LB MAX

2 = 2x 33 LB MAX

3 = 3x 33 LB MAX



Must use the included 2 safety straps to stabilize the bikes during driving. Any accident or damage caused by not following this instruction will not be covered!



Before ordering, please measure and note the following limits.

Not fit vehicles with rear mounted spare tire.

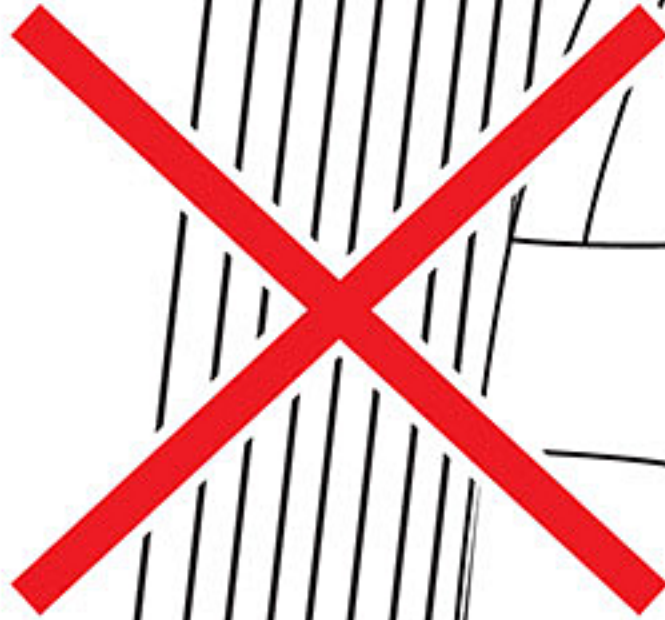

Distance between your rear bumper edge and hitch's center hole must not be longer than 6.5 inches.

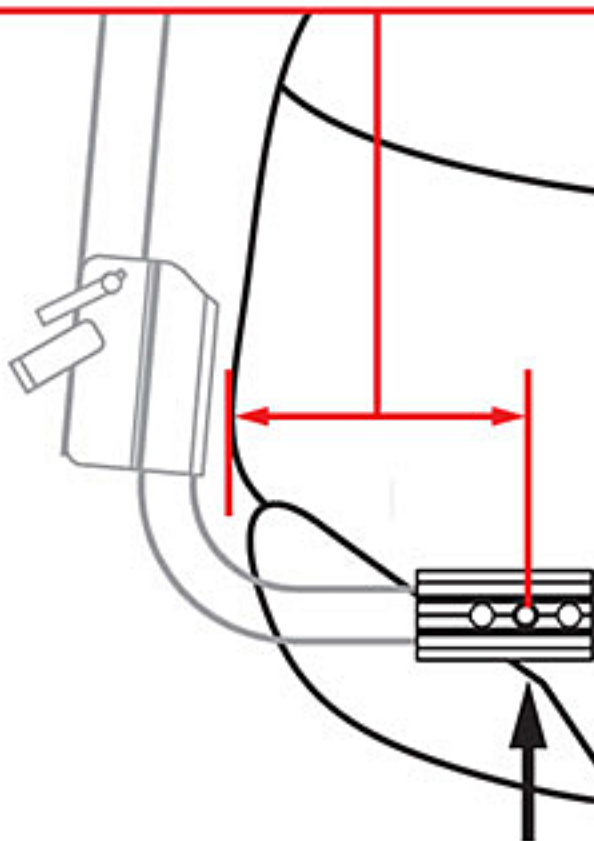

Center of Hitch Pin Hole