

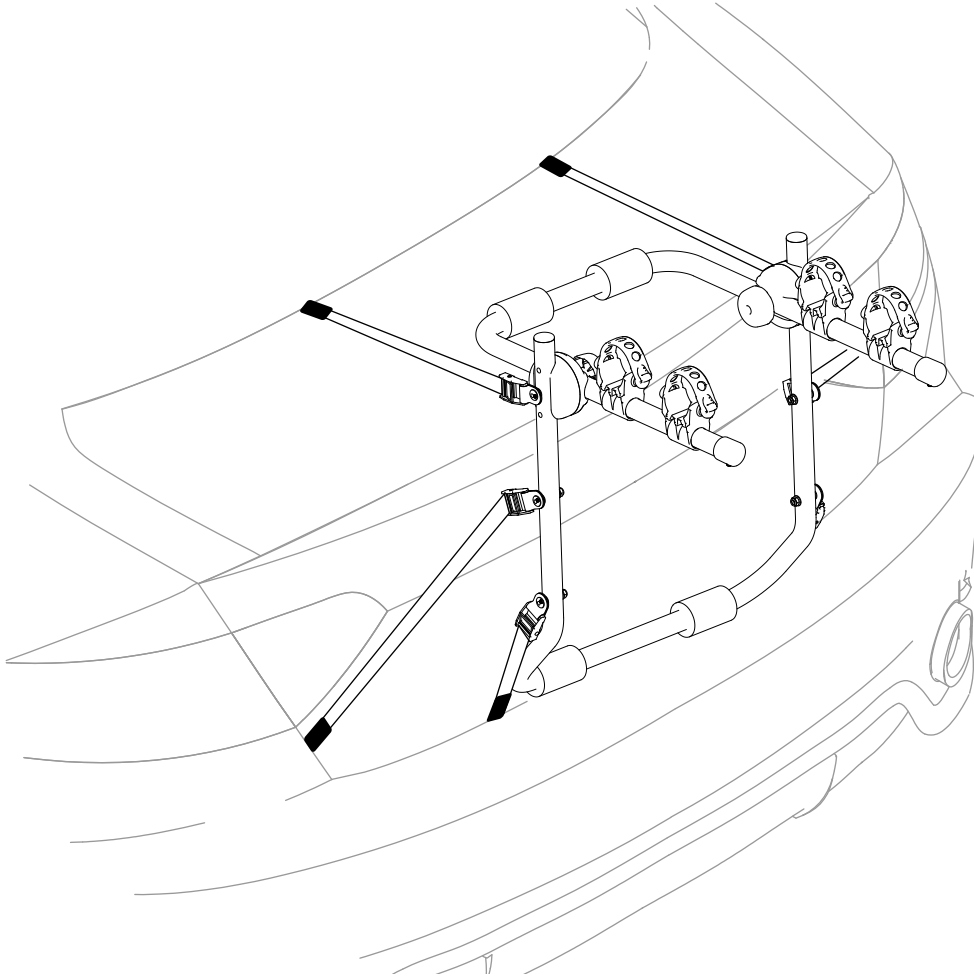

TYGER



MAX 30KG

2 Bike TYGER TG-RK2B202B

PARTS LIST

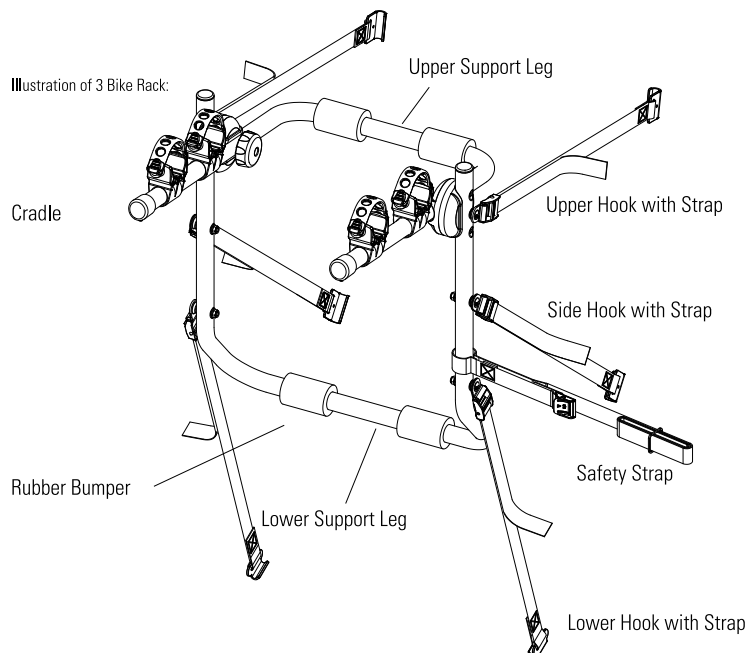

1

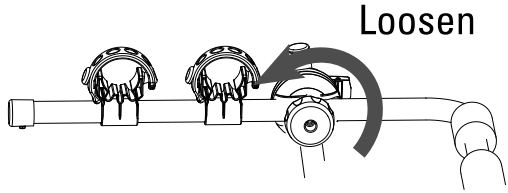

2

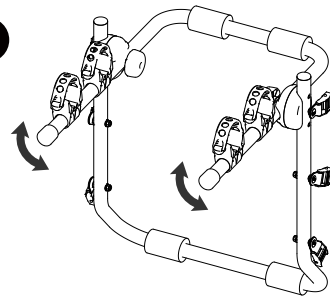

GB-US - Regular mounting: only attach to metallic edges!!!

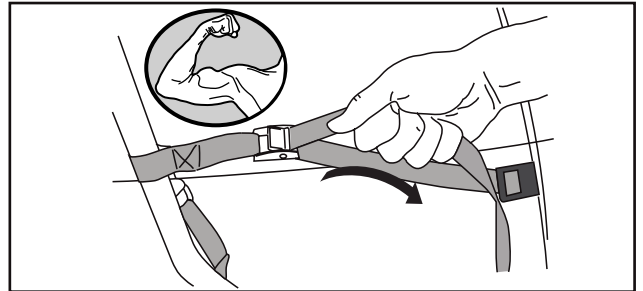
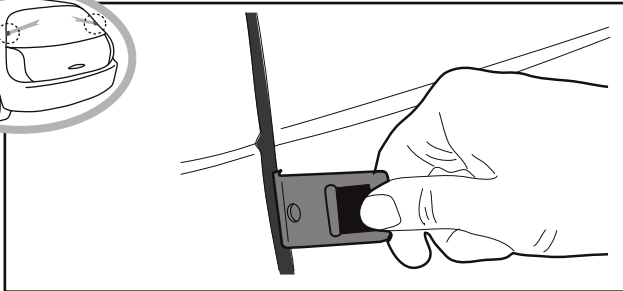
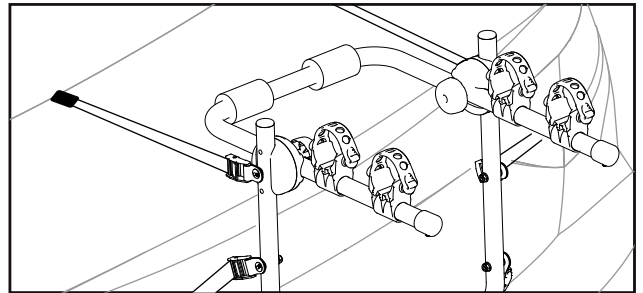
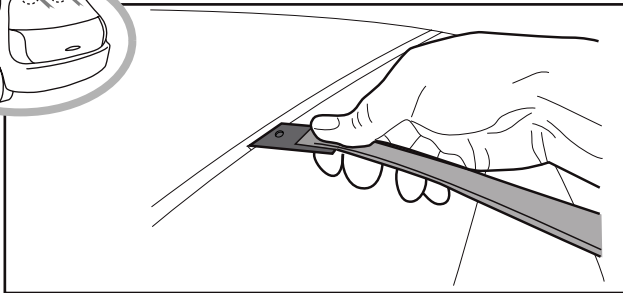
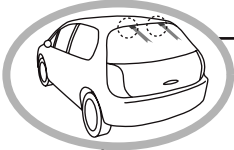

OK

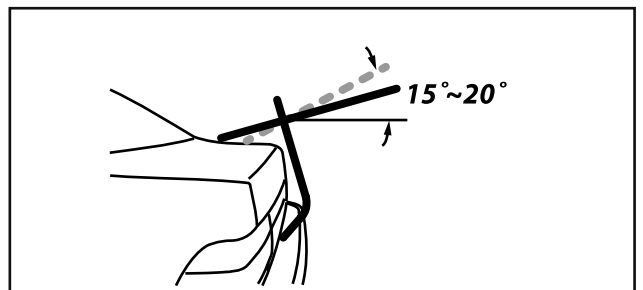
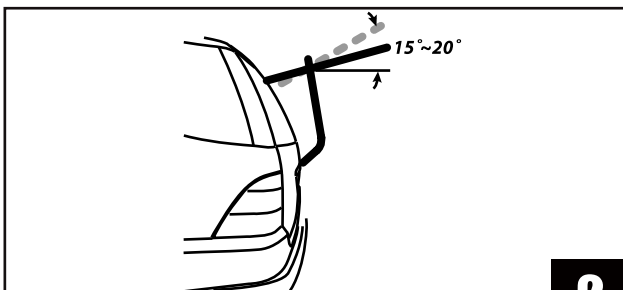
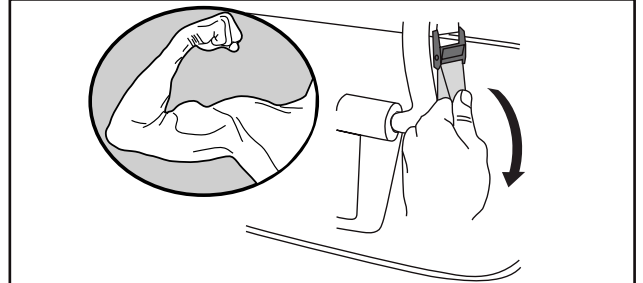
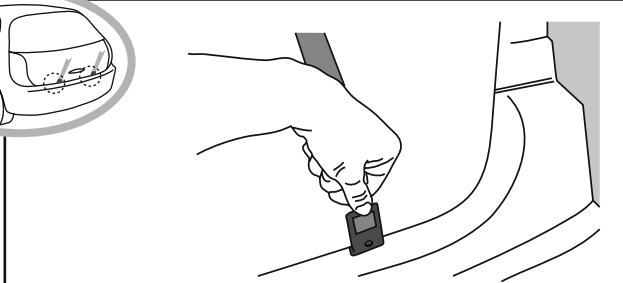
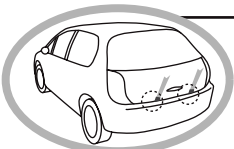
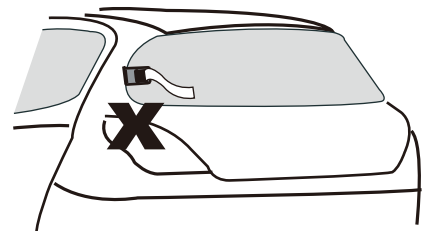
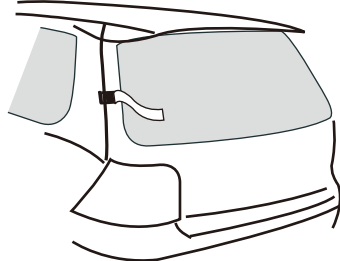

2

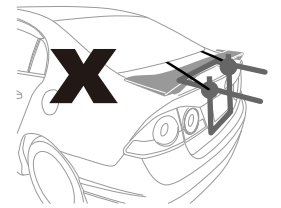
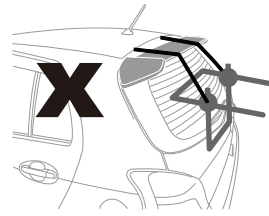
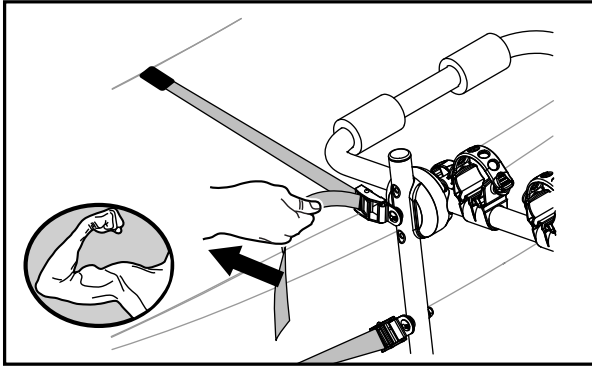

GB-US - it cannot fit the cars with a rear spoiler

GB-US - Mounting of the bikes



Cradle positions adjustable

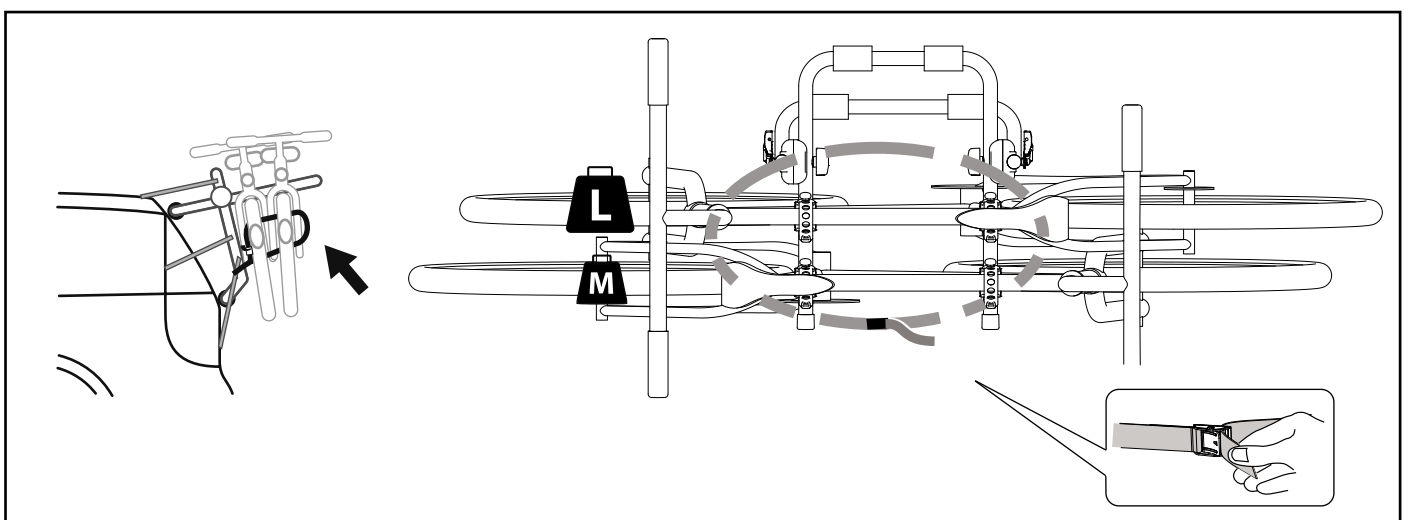
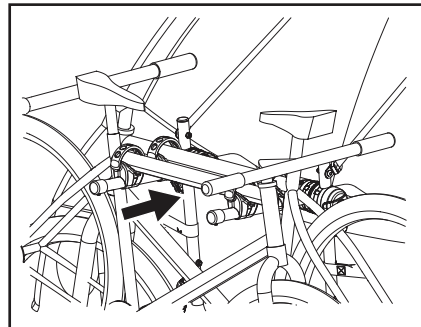
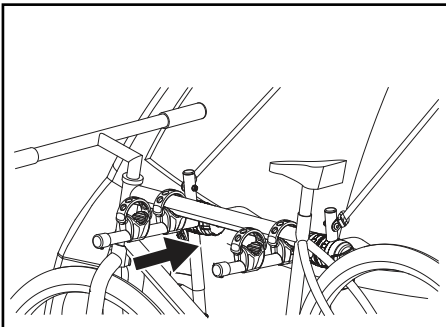
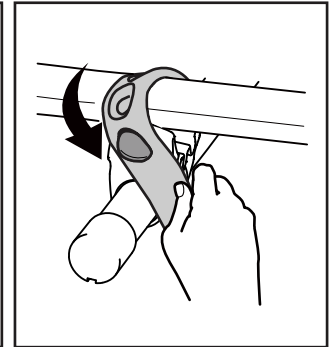
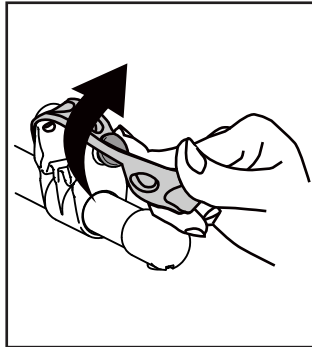
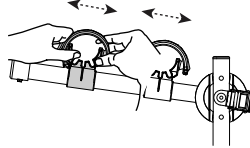

GB-US - Double check that all the straps are correctly tightened after installing the bikes

WARNINGS

GENERAL REMARKS

01. Please read and observe the instructions carefully before you use the product, and keep them in a safe place for future use. Check the part list after opening the package. Make sure that all the parts are fully assembled according to the instruction before fitting it on your car.
02. The user is responsible for assembly and installation of this product, and the manufacturer disclaims any liability due to improper fitting or use of the product.
03. Failure to properly install this bike carrier and/or the bikes may cause damage to the vehicle and/or the bikes, and may result in personal injury.
04. Do not use this product for purposes other than those for which it is designed. Do not modify any components of the product. Remove the carrier if not in use.
05. Do not use the carrier to carry more bikes than recommended. The weight of each bike cannot exceed 15 kg/ 33 lbs.
06. Do not install the bike carrier on trailers, campers, or RVs.
07. This bike rack is not intended for transporting tandem, or recumbent bicycles.
08. Do not transport bicycles with attached baby seats, panniers, wheel covers, full bike covers or motors.
09. Depending on the shape of your bicycle, TYGER cannot guarantee that it will fit properly on this carrier. You might have to use the frame adapter for bicycle without top bar.

SAFE AND PROPER USE

01. Clean the surface of the tailgate before installing the rack.
02. Always use the safety strap to attach the bikes to the bike carrier.
03. Make sure that the tailgate of your car allows you to use a trunk rack - some parts like spoilers, wind defectors may not allow you to use a trunk rack.
04. Check if the distance from the exhaust pipe to the bicycle tires is safe for your bicycles or the straps of the carrier. The heat of the exhaust could damage the bike or bicycle racks.
05. Check if the back wiper will not interfere with the bike carriers before using it. If it does and it is an automatic one, please disconnect it.
06. If your vehicle is equipped with an automatic tailgate opening system, disable this function when using the bike carrier, and open the tailgate manually.
07. When loading the bicycles, remove all loose parts and accessories from bicycles (toolbars, baby carriers, pumps, etc.)
08. Always position the biggest/heaviest bike first and closest to the car, and then position the smaller bike after that.
09. The user is responsible for periodically verifying that all hardware, straps, knobs, hubs are securely tightened for safety purposes.
10. You might have to use extra protections to protect the bikes and the tailgate from scratches.
11. Do not open the tailgate with the bikes installed on the carrier.

ROAD SAFETY

01. If the bikes and/or the carrier obstruct the vehicle's tail lights and license plate, you must use an additional signal board.
02. The bicycle rack increases the vehicle's length, and the bicycles may increase its width and height. Be aware of this when passing through narrow or low clearance spaces and when reversing. Any loads exceeding the indicated dimensions must nevertheless respect existing regulations and be properly strapped down.
03. The load of rack and bicycles will affect driving. Do not exceed the speed limit, and do not drive faster than 120 km/h (75 mph).
04. Drive slowly over speed bumps. Respect the speed limit, and adapt your speed to the condition of the road.
05. Off-road driving is not recommended and could result in damage to your vehicle, hitch receiver, bike carrier, or your bikes. If you hit a bump or a hole in the road, stop your vehicle and inspect the bikes and the carrier. If you notice anything wrong, remove the bikes and do not use the bike carrier.
06. Make sure there is a safe distance between the bikes and the ground, especially when entering a driveway.

MAINTAINING YOUR BICYCLE RACK

01. Periodically inspect the product for signs of wear, corrosion, and fatigue.
02. Do not use the carrier with defective parts, contact the dealer to replace them before using it again.
03. Remove the product before entering an automatic car wash.
04. To keep your product in the best condition, it is recommended to remove the product from the car when not in use. Please be advised that this product is not designed to resist extreme weather conditions, especially sea coast air.
05. Lubricate the bolts in order to avoid corrosion.