

# WHY TYGER?

THE QUALITY YOU CAN TRUST.

**1** Made from Impact-Resistant Polypropylene



**2** Smooth Matte Black Surface and Paintable

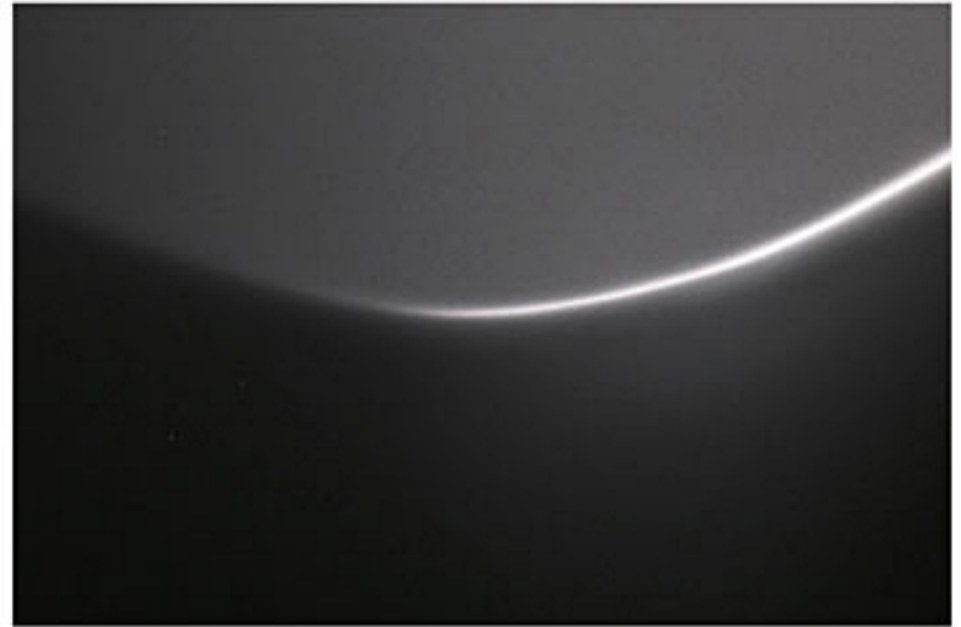

**3** Distinctive Pocket & Rivet Design



**4** Even thickness with Injection Moulding



**5** 304 Marine Grade Stainless Rivets



**6** Edge Trim to Protect Vehicle from Scratch



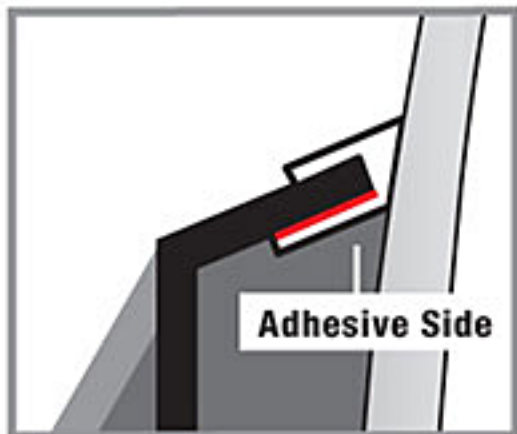

Edge Trim minimizes friction to prevent scratching

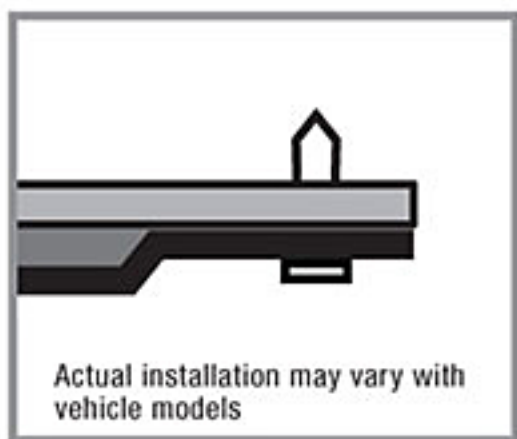
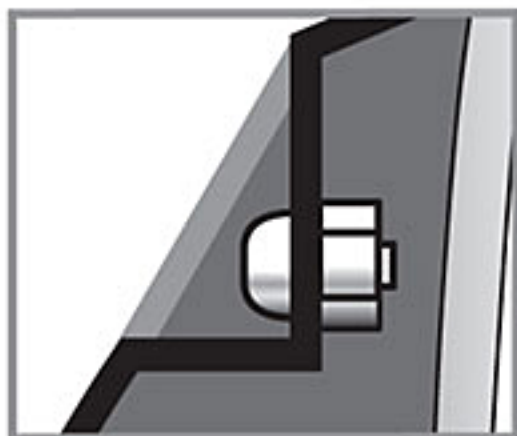

Secures using factory screws OR supplied hardware  
(Hardware supplied is vehicle specific)

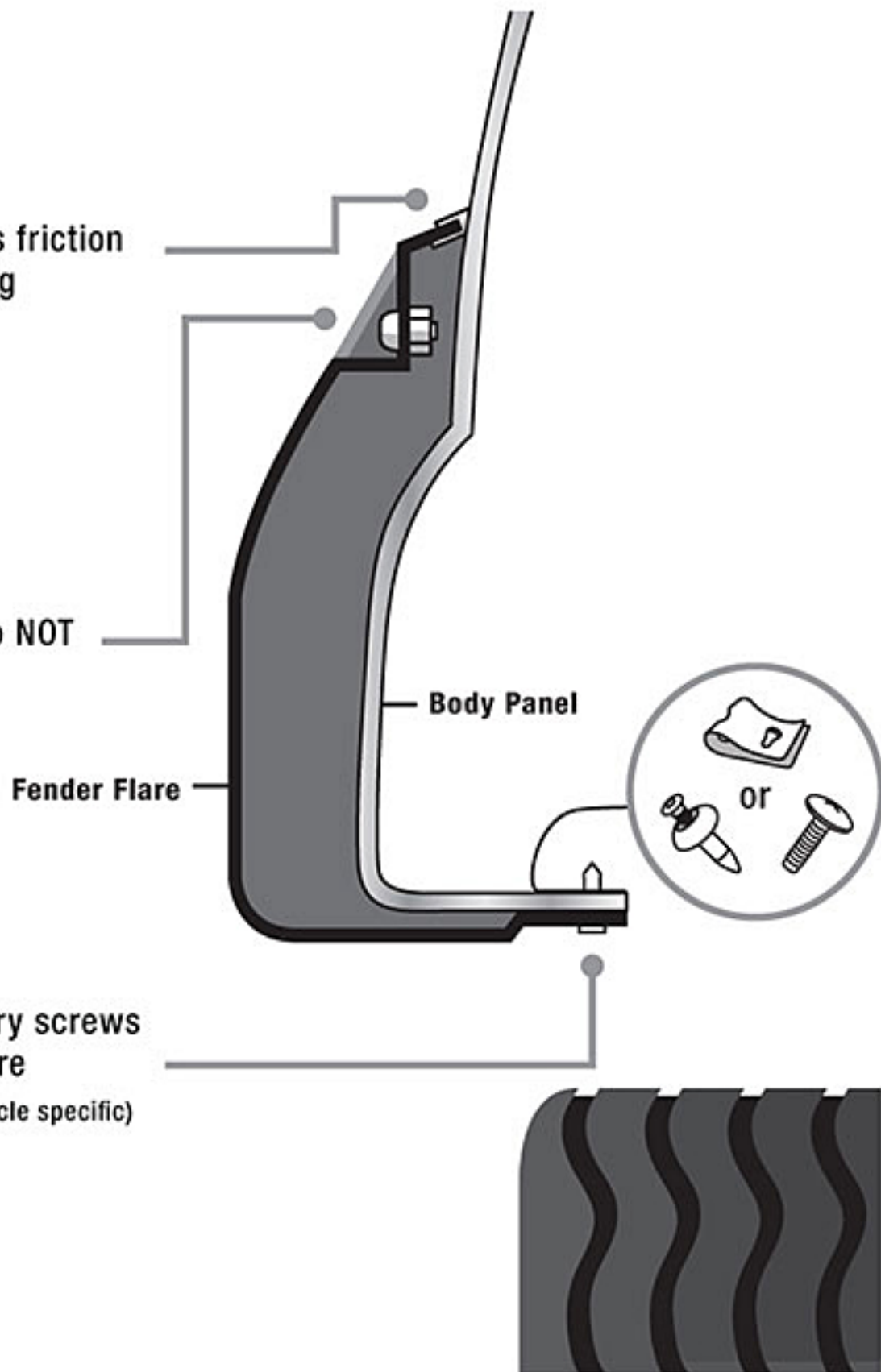



# BUILT TO BE TOUGH!



Made with  
Injection Molding technology.

Made of  
Impact Resistant Polypropylene,  
Not the cheap ABS plastic.

( Actual products may vary by specific vehicles. )



# EXTRA TIRE COVERAGE

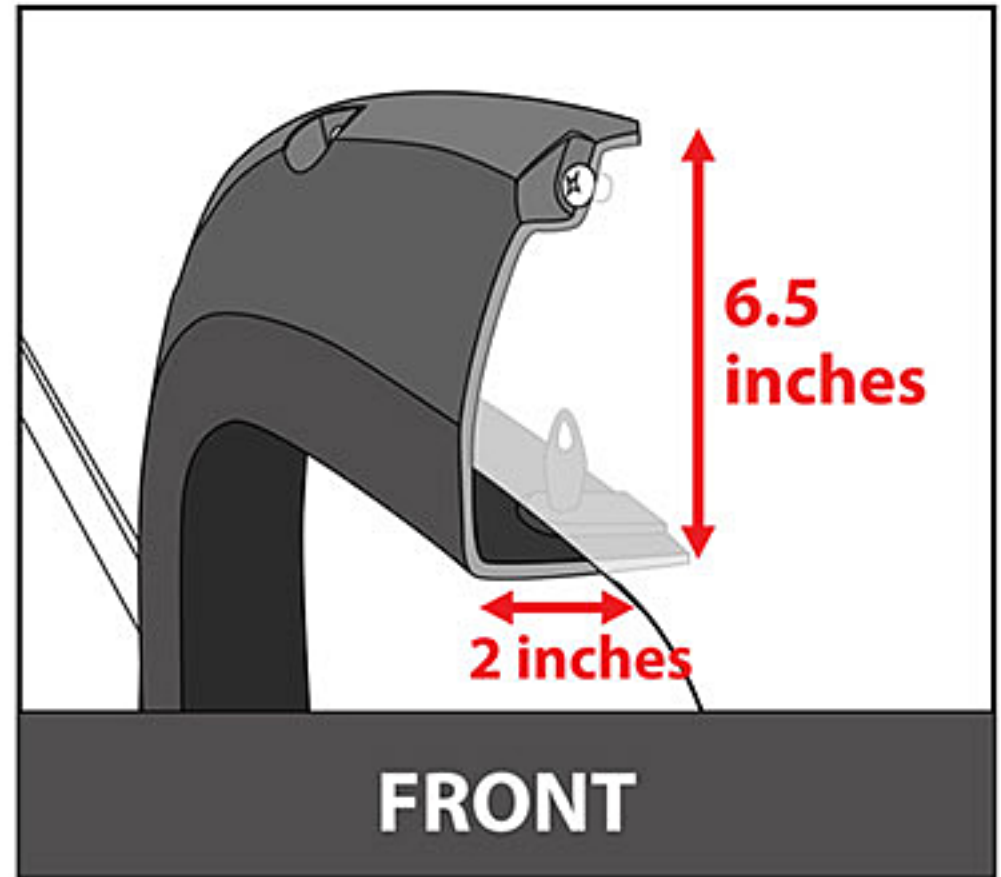
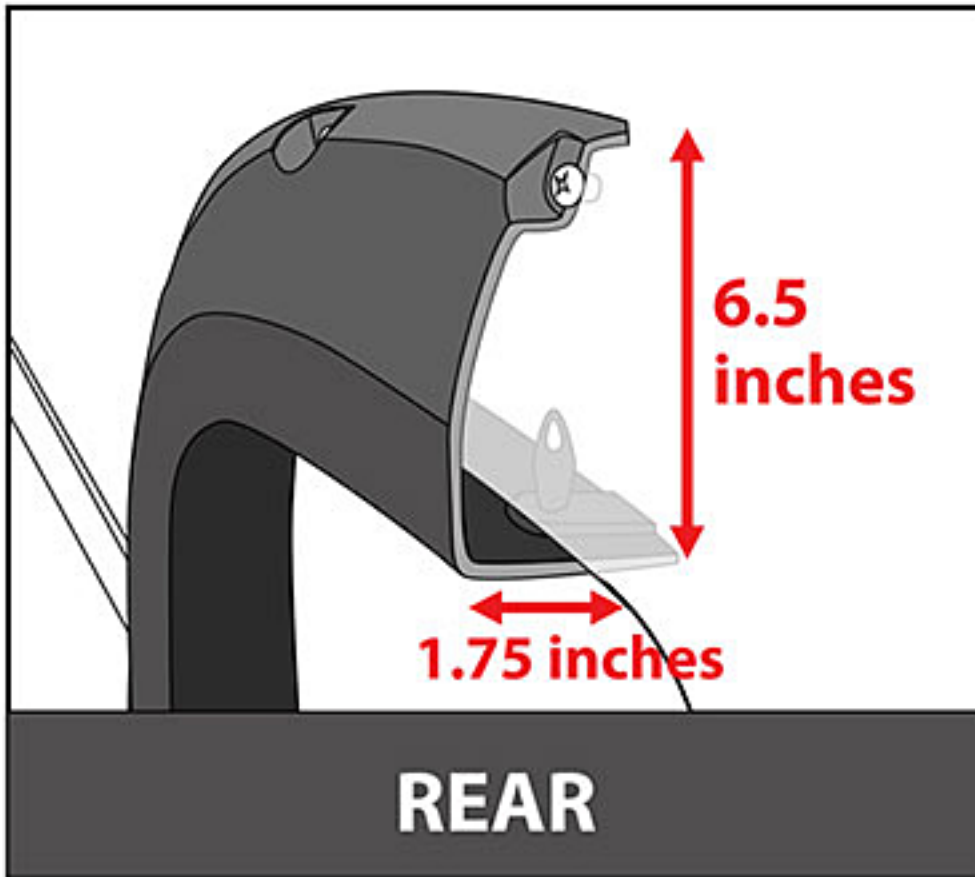

Feel the difference with Tyger.

Shop the largest selection of fender flares in our online store.