



# TYGER®

## TYGER BLADE

TG-BL8C7158

### BEFORE INSTALLATION

READ INSTRUCTIONS CAREFULLY BEFORE STARTING INSTALLATION. REMOVE CONTENTS FROM BOX AND VERIFY ALL PARTS ARE PRESENT. FAILURE TO IDENTIFY DAMAGE BEFORE INSTALLATION COULD LEAD TO A REJECTION OF ANY CLAIM. IF MISSING PARTS OR ANY DAMAGE FOUND, PLEASE TAKE A PICTURE FOR THE CLAIM PURPOSE.

### TORQUE VALUES

Fastener Size	Class 8.8 Torque (ft-lbs)	Class 10.9 Torque (ft-lbs)
6mm	6-7	6-7
8mm	15-16	22-23
10mm	31-32	44-45
12mm	54-55	78-79
14mm	87-88	125-126

### Parts List

- x2 TYGER Running Boards
- x2 Double Bolt Plate
- x8 Mounting Brackets
- x16 8-1.25mm x 30mm Hex Bolts
- x32 8mm x 24mm x 2mm Flat Washers
- x16 8mm Lock Washers
- x16 8mm Nylon Lock Nuts





# TYGER<sup>®</sup>

## STEP 1

Start the installation under the Driver/Left of the vehicle. Locate the 6 plugs along the bottom of the body. Mounting Brackets will bolt to the 1st, 3rd, 4th and 6th threaded holes, (Figs 1-6).

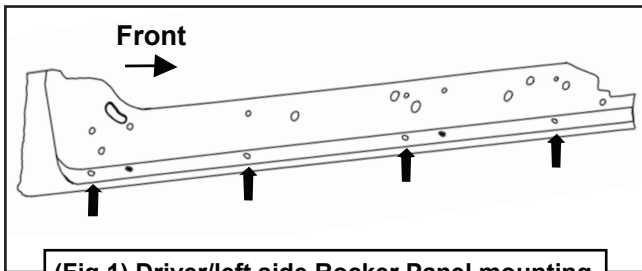

(Fig 1) Driver/left side Rocker Panel mounting locations illustrated (arrows) NOTE: Hold Bracket up to body panel to help determine the correct mounting locations.

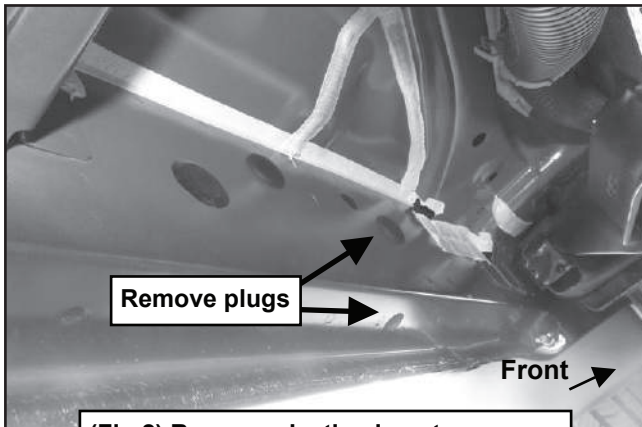

(Fig 2) Remove plastic plugs to uncover threaded inserts

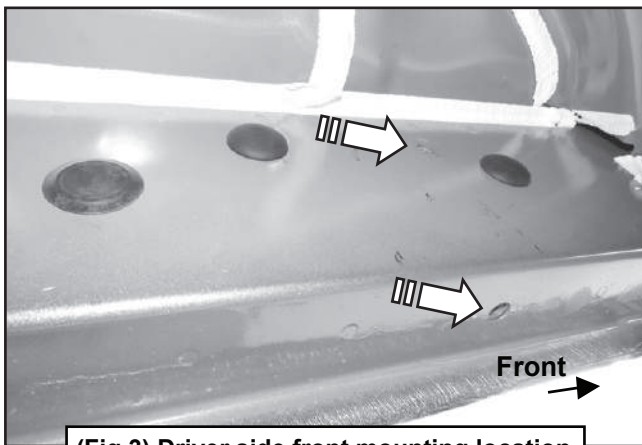

(Fig 3) Driver side front mounting location

Remove the plastic plugs from each mounting location. Directly above each threaded insert is a top mounting location on the side of the body panel. Hold a Bracket up in place to help determine the correct mounting holes to use along the body.

**NOTE:** Thread an 8mm Hex Bolt into the threaded inserts to clear paint as required.

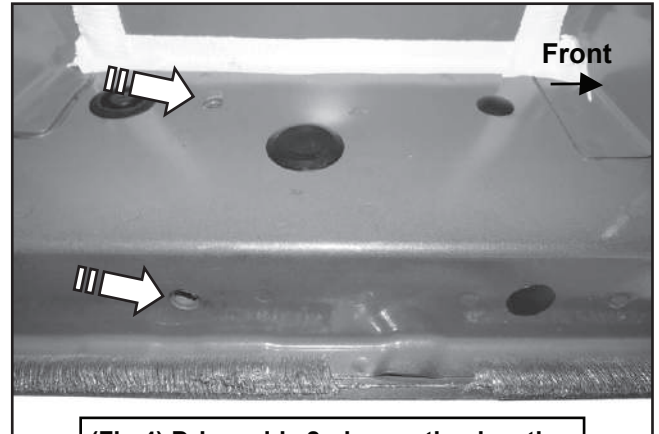

(Fig 4) Driver side 2nd mounting location

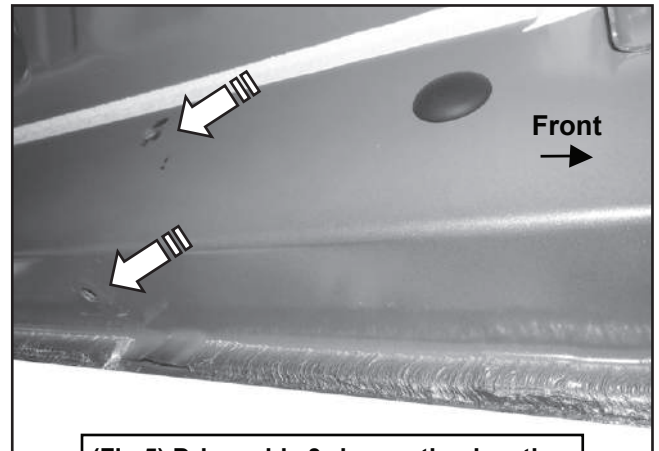

(Fig 5) Driver side 3rd mounting location

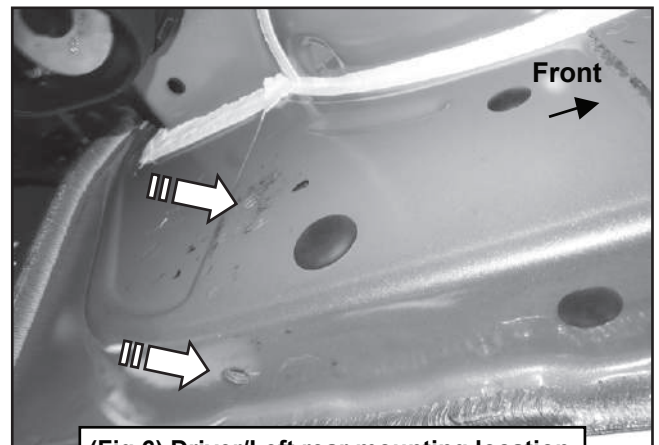

(Fig 6) Driver/Left rear mounting location



# TYGER<sup>®</sup>

## STEP 2

Select (1) Mounting Bracket. Starting at the front of the driver/left side, bolt the Mounting Bracket to the factory threaded holes with (2) 8mm Hex Bolts, (2) 8mm Lock Washers and (2) 8mm Flat Washers, (Figs 7-8). Do not tighten hardware at this time.

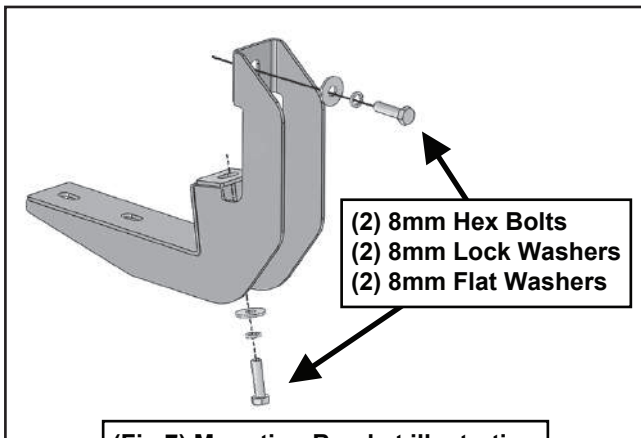

(Fig 7) Mounting Bracket illustration

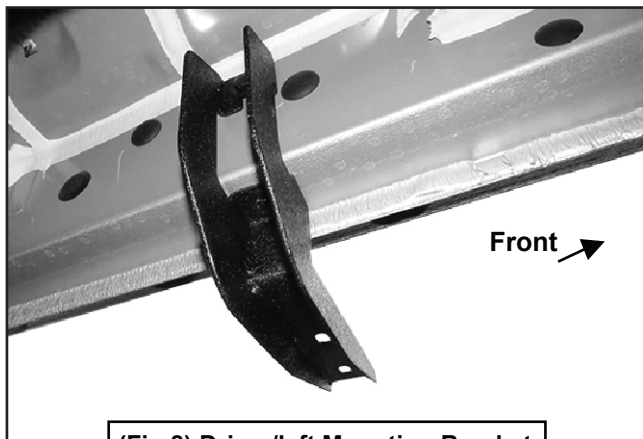

(Fig 8) Driver/left Mounting Bracket

## STEP 3

Repeat Step 2 to install (3) Mounting Brackets on the remaining driver/left side mounting locations along the body panel.

## STEP 4

Select (1) Running Board. Place the Running Board on top of the Brackets. Locate the channel in the bottom of the Running Board. Select (4) 8mm Double Bolt Plates. Insert the Bolt Plates into the channel in the bottom of the Running Board closest to the Brackets, (Fig 9). Lift the Board up and guide the studs through the Brackets.

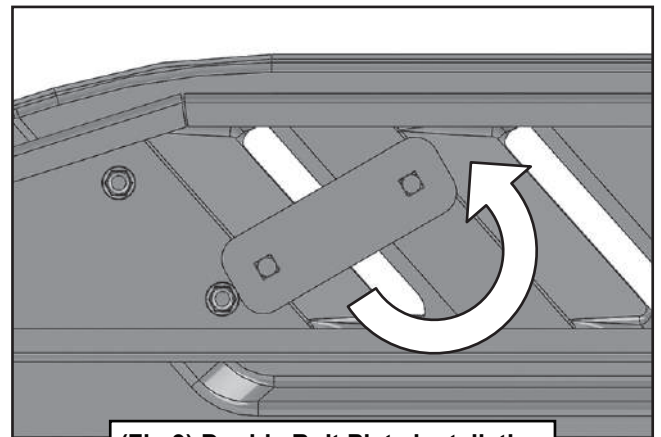

(Fig 9) Double Bolt Plate installation



# TYGER<sup>®</sup>

## STEP 5

Attach the Running Board to the Brackets with (8) 8mm Flat Washers and (8) 8mm Nylon Lock Nuts, (Figs 10-14).

## STEP 6

Level and adjust the Running Board and fully tighten all hardware.

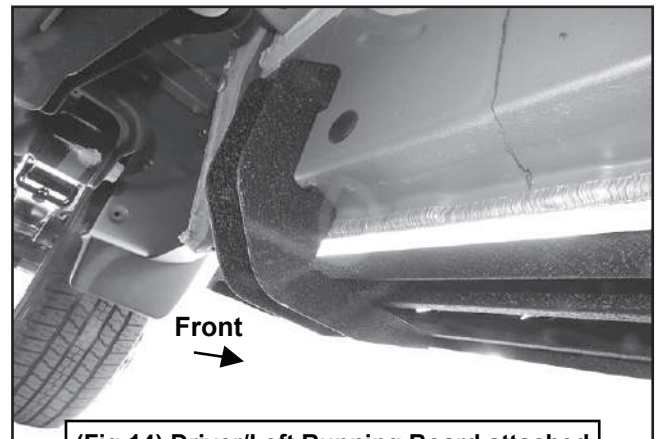
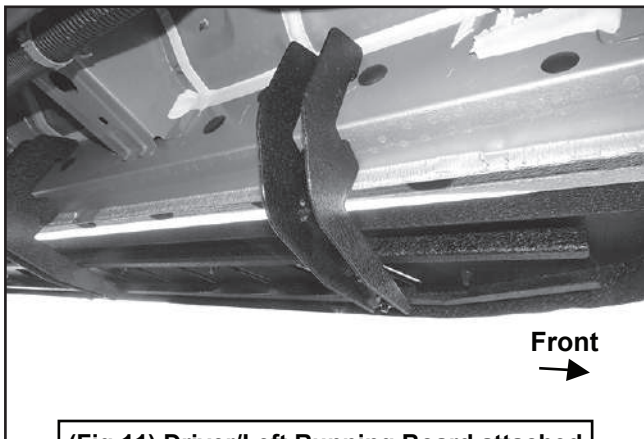
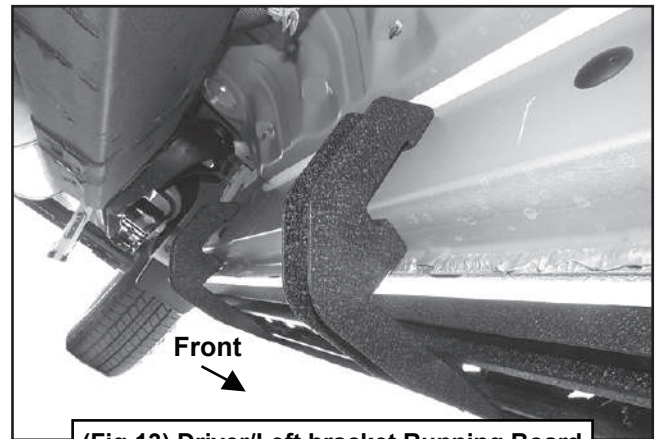
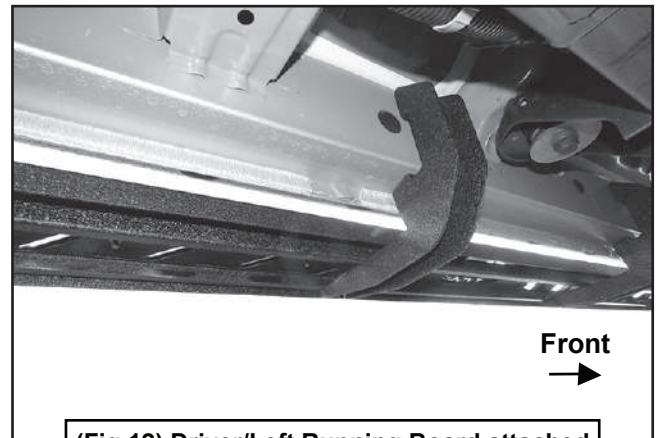
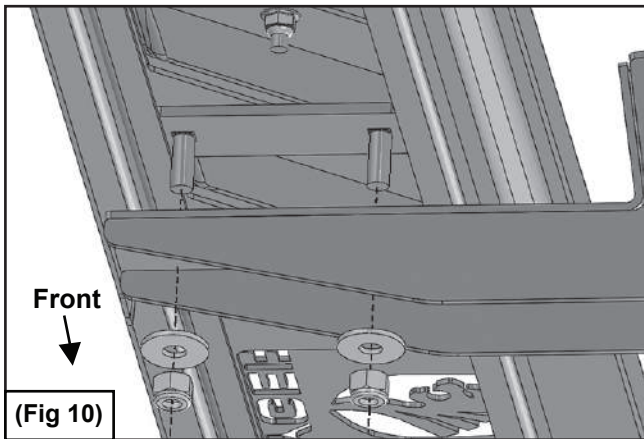



# TYGER<sup>®</sup>

## STEP 7

Repeat Steps 2-5 to install the Passenger/right Running Board.

## STEP 8

Do periodic inspections to the installation to make sure that all hardware is secure and tight.