



Installation manual
 3" SUSPENSION SYSTEM
 1994 — 2002 Dodge Ram 2500/3500
 OLD PART # D32B
 NEW PART # 33920
 sj060506rev.02

Old part # D32B
 New part # 33920
 Dodge Ram 2500/3500 3" suspension system
 Parts list:

<u>Part #</u>	<u>Description</u>	<u>Qty.</u>
D31-001	3" Upper coil spring spacer	2
D31-002	Upper control arm	2
D31-003	Lower control arm	2
D31-004	Front driver side track bar bracket	1
TC1-R22D	Rear add-a-leaf	2
CB12	Hardware bag	1
D31NB	Hardware bag	1
D31PL	Poly bushing bag	1
D31SL	Sleeve bag	1
D51SL	Sleeve bag	1
PB8297	Upper shock stem bushings	4
LUBE	Poly lube packs	2
SERT	Sert fittings	8
33920INST	Instruction sheet (customer copy)	1
33920INST	Instruction sheet (installer copy)	1
MIRRORHANGER	Rear view mirror hanger	1
WARNINGDECAL	Warning decal	1
DECAL	Window sticker	1

Important customer information

Tuff Country EZ-Ride Suspension highly recommends that a qualified or a certified mechanic performs this installation.

If you desire to return your vehicle to stock, it is the customers responsibility to save all stock hardware.

It is the responsibility of the customer or the mechanic to wear safety glasses at all times when performing this installation.

It is the customers/installers responsibility to read and understand all steps before installation begins. OEM manual should be used as a reference guide.

This vehicles reaction and handling characteristics may differ from standard cars and/or trucks. Modifications to improve and/or enhance off road performance may raise the intended center of gravity. Extreme caution must be utilized when encountering driving conditions which may cause vehicle imbalance or loss of control. **DRIVE SAFELY!** Avoid abrupt maneuvers: such as sudden sharp turns which could cause a roll over, resulting in serious injury or death.

It is the customers responsibility to make sure that a re-torque is performed on all hardware associated with this suspension system after the first 100 miles of installation. It is also the customers responsibility to do a complete re-torque after every 3000 miles or after every off road use.

After the original installation, Tuff Country EZ-Ride Suspension also recommends having the alignment checked every 6 months to ensure proper tracking, proper wear on tires and front end components. Tuff Country EZ-Ride Suspension takes no responsibility for abuse, improper installation or improper suspension maintenance.

Congratulations on your selection to purchase a Tuff Country EZ-Ride Suspension System. We at Tuff Country EZ-Ride Suspension are proud to offer a high quality product at the industries most competitive pricing. Thank you for your confidence in us and our product.

For a list of all parts, please refer to the Parts Description Page, at the end of the Installation Manual.

Make sure to use thread locker or locktite on all new and stock hardware associated with the installation of this suspension system.

It is the responsibility of the installers to make sure that the rear view mirror hanger is hung from the rear view mirror. The rear view mirror hanger has instructions on proper post installation procedure.

The Tuff Country EZ-Ride Suspension product safety label that is included in your kit box must be installed inside the cab in plain view of all occupants.

LIMITED LIFETIME WARRANTY

Notice to all Tuff Country EZ-Ride Suspension customers: It is your responsibility to keep your original sales receipt! If failure should occur on any Tuff Country EZ-Ride Suspension component, your original sales receipt must accompany the warranted unit to receive warranty. Warranty will be void if the customer can not provide the original sales receipt. Do not install a body lift in conjunction with a suspension system. If a body lift is used in conjunction with any Tuff Country EZ-Ride Suspension product, your Tuff Country EZ-Ride Suspension **WARRANTY WILL BE VOID**. Tuff Country Inc. ("Tuff Country") suspension products are warranted to be free from defects in material and workmanship for life if purchased, installed and maintained on a non-commercial vehicle; otherwise, for a period of twelve (12) months, from the date of purchase and installation on a commercial vehicle, or twelve thousand (12,000) miles (which ever occurs first). Tuff Country does not warrant or make any representations concerning Tuff Country Products when not installed and used strictly in accordance with the manufacturer's instructions for such installation and operation and accordance with good installation and maintenance practices of the automotive industry. This warranty does not apply to the cosmetic finish of Tuff Country products nor to Tuff Country products which have been altered, improperly installed, maintained, used or repaired, or damaged by accident, negligence, misuse or racing. ("Racing is used in its broadest sense, and, for example, without regards to formalities in relation to prizes, competition, etc.) This warranty is void if the product is removed from the original vehicle and re-installed on that or any other vehicle. This warranty is exclusive and is in lieu of any implied warranty of merchantability, fitness for a particular purpose or other warranty of quality, whether express or implied, except the warranty of title. All implied warranties are limited to the duration of this warranty. The remedies set forth in this warranty are exclusive. This warranty excludes all labor charges or other incidental or consequential damages. Any part or product returned for warranty claim must be returned through the dealer of the distributor from whom it was purchased. Tuff Country reserves the right to examine all parts returned to it for warranty claim to determine whether or not any such part has failed because of defect in material or workmanship. The obligation of Tuff Country under this warranty shall be limited to repairing, replacing or crediting, at its option, any part or product found to be so defective. Regardless of whether any part is repaired, replaced or credited under this warranty, shipping and/or transportation charges on the return of such product must be prepaid by the customer under this warranty.

Important information that needs to be read before installation begins:

Before installation begins, Tuff Country EZ-Ride Suspension highly recommends that the installer performs a test drive on the vehicle. During the test drive, check to see if there are any uncommon sounds or vibrations. If uncommon sounds or vibrations occur on the test drive, uncommon sounds or vibrations will be enhanced once the suspension system has been installed. Tuff Country EZ-Ride Suspension highly recommends notifying the customer prior to installation to inform the customer of these issues if they exist.

New longer front and rear shocks are needed after this suspension system has been installed and the front and rear shocks need to be ordered as a separate part #. If you have not already ordered your front and rear shocks, please feel free to contact Tuff Country or your local Tuff Country dealer and order your front and rear shocks. Tuff Country recommends installing a 26" fully extended nitrogen gas shock in the front and a 30" fully extended nitrogen gas shock in the rear.

After the installation of this suspension system, Tuff Country highly recommends taking the vehicle directly to an alignment shop for a proper front end alignment.

Some 3/4 ton and 1 ton Dodge come with a rear brake proportioning valve in the rear end. If the vehicle that you are working has this option, the rear brake proportioning valve needs to be relocated and the relocation bracket needs to be ordered as a separate part #. If you have not already ordered your rear brake proportioning valve bracket, please contact Tuff Country or your local Tuff Country dealer and order part # 30910 (D35PB)

Torque Settings

5/16"	15—18 ft lbs.
3/8"	28—32 ft lbs.
7/16"	30—35 ft lbs.
1/2"	65—85 ft lbs.
9/16"	85—120 ft lbs.
5/8"	95—130 ft lbs.
3/4"	100—140 ft lbs.

Poly bushing bag D3IPL includes:

<u>Description</u>	<u>Quantity</u>
PB2408 (poly bushings)	16

Sleeve bag D3ISL includes:

<u>Description</u>	<u>Quantity</u>
S10029 (.875" X .500" X 2.250")	4
S10030 (.875" X .560" X 2.625")	4

Sleeve bag D5ISL includes:

<u>Description</u>	<u>Quantity</u>
S10042 (.875" X .563" X 2.250")	4
S10043 (.875" X .693" X 2.760")	4

Hardware bag D3INB includes:

<u>Description</u>	<u>Quantity</u>
3/8" x 1 1/2" bolts	4
7/16" USS flat washers	4
5/16" USS flat washers	10
1/2" x 1 1/2" bolts	2
3/8" fender washer	4
3/8" nylon insert nut	6
1/2" unitorque nut	2

Hardware bag CB12 includes:

<u>Description</u>	<u>Quantity</u>
1/2" x 6" centering bolt	2
1/2" fine nut	2

Special note: Before installation begins, it is the customers/installers responsibility to make sure that all parts are on hand. If any parts are missing, please feel free to call one of our customer service representatives @ (801) 280-2777.

Tuff Country EZ-Ride Suspension highly recommends that the customer or the installer checks to make sure that all parts are on hand before the installation begins. If any parts are missing, please feel free to call one of our customer service representatives @ (801) 280-2777.

Please follow instructions carefully:

Before installation begins, measure from the center of the hub, to the bottom of the fender well, and record measurements below.

Pre-Installation measurements:

Driver Side Front: _____
Passenger Side Front: _____
Driver Side Rear: _____
Passenger Side Rear: _____

At the end of the installation, take the same measurements and compare to the pre-installation measurements.

Post-Installation measurements:

Driver Side Front: _____
Passenger Side Front: _____
Driver Side Rear: _____
Passenger Side Rear: _____

Front end installation:

1. To begin installation, block the rear tires of the vehicle so that the vehicle is stable and can't roll backwards. Safely lift the front of the vehicle, and support the frame with a pair of jack stands. Place a jack stand on both the driver and passenger side. Next, remove the tires and wheels from both sides.

2. Position a pair of hydraulic floor jacks under the front axle. Place one jack stand on the driver side and one on the passenger side. Carefully raise up on both hydraulic floor jacks at the same time until they make contact with the front axle.

3. Working on the driver side, un-bolt the stock sway bar at the frame location and save the stock hardware for later re-installation. Repeat procedure on passenger side.

Let the stock sway bar hang.

4. Working on the passenger side, remove the stock hardware that connects the stock track bar to the stock location. Save the stock hardware for later re-installation.

5. Working on the driver side lower control arm axle mount, scribe a mark on the stock alignment cams and reinforcement bracket. This mark will be used as a reference when installing the new front lower control arms. Repeat procedure on the passenger side.

Illustration # 1

6. Working on the driver side, scribe a mark on the stock coil spring and another directly across on the stock lower coil spring pocket. **Special note: scribe the mark on the bottom of the stock coil spring and one directly**

across on the lower coil spring pocket. This will allow you to re-install the stock coil spring back into the stock location at a later step. Repeat procedure on passenger side.

7. Working on the driver side, locate the top of the stock shock absorber stud in the engine compartment. Remove the stock nut, retainer washer and grommet. The stock upper shock nut, retainer washer and grommets may be discarded. Repeat procedure on passenger side.

Illustration # 2

8. Working on the driver side, remove the stock (3) nuts from the stock upper shock tower and discard the stock nuts. Set the stock upper shock tower a side for later re-installation. Repeat procedure on the passenger side.

Illustration # 3

9. Working on the driver side, remove the stock lower shock bolt that connects the stock shock to the stock lower mounting location. Save the stock hardware for later re-installation. Remove the stock shock by lifting the stock shock up through the engine compartment. The stock shock may be discard. **Special note: New longer front shocks are needed once this suspension system has been installed and the front shocks need to be ordered as a separate part #. If you have not already ordered your new front shocks, please feel free to contact Tuff Country or your local Tuff Country dealer and order your new front shocks. Tuff Country recommends installing a 26" fully extended nitrogen gas shock in the front.** Repeat procedure on the passenger side.

10. Working on the driver side, remove the stock upper control arm from the stock frame location and the stock axle location. Save the stock hardware. The stock upper control arm may be discarded. Repeat procedure on the passenger side.

11. Working on the driver side, remove the stock lower control arm from the stock frame location and the stock axle location. Save the stock hardware. The stock lower control arm may be discarded. Repeat procedure on the passenger side.

12. Working on the driver side, remove the stock brake line bracket that is located between the stock upper and lower control arm mounting point that is located on the stock front axle. Save the stock hardware for later re-installation. Let the stock brake line bracket hang. Repeat procedure on the passenger side.

13. Carefully lower down on both hydraulic floor jacks at the same time approximately 4". Working on the driver side, remove the stock coil spring from the stock location and set a side for later re-installation. Next, remove the stock rubber isolation pad and stock shock ring from the stock upper shock pocket. Set the stock rubber isolation pad a side for later re-installation. The stock shock ring

may be discarded. Repeat procedure on passenger side. **Special note: Before removal of the stock coil spring, make sure that you scribed a mark on the stock coil spring and the stock coil spring pocket in step # 6.**

Special note: If the vehicle that you are working on was manufactured before 09/01/01 please follow steps # 14 — 22.

Special note: If the vehicle that you are working on was manufactured after 09/01/01 please follow steps # 23 — 31.

14. Locate the new lower control arms. **Special note: The new lower control arms are the longer arms that are included in this suspension system.** Also, locate (8) PB2408 poly bushings from poly bag D3IPL. Insert the new poly bushings into each end of the new lower control arms. **Special note: Make sure to use a lithium or moly base grease prior to inserting the new bushings into the new lower control arms. This will increase the life of the bushing as well as prevent squeaking.**

15. Locate (4) new S10030 crush sleeves from sleeve bag D3ISL. Insert the new S10030 crush sleeves into the previously installed poly bushings in the new lower control arms.

16. Locate (4) sert fitting that where packaged with the installer copy of the instruction sheet. Carefully install the sert fittings into each end of the new lower control arms. **Special note: Take special care not to damage the sert fittings during installation.**

17. Locate the stock lower control mounting hardware that was removed in step # 11. Working on the driver side, install the new lower control arm into the stock frame mount location and secure using the stock hardware. **Make sure to use thread locker or lock tite. Do not fully tighten at this point.** On the stock front bolt that connects the new lower control arm to the stock front bracket, refer to the reference marks that were made in step # 4 and re-install into the same location. **Make sure to use thread locker or lock tite. Do not fully tighten at this point. Special note: Raising the axle to ride height and moving the axle up and down will help make installation of the new lower control arm a little easier. Slight prying of the stock control arm bracket also may be needed to make installation easier.** Repeat procedure on passenger side.

Illustration # 4

18. Locate the new upper control arms. **Special note: The new upper control arms are the shorter arms that are included in this suspension system.** Also, locate (8) PB2408 poly bushings from poly bag D3IPL. Insert the new poly bushings into each end of the new upper control arms. **Special Note: Make sure to use a lithium or moly base grease prior to inserting the new**

bushings into the new upper control arms. This will increase the life of the bushing as well as prevent squeaking.

19. Locate (4) new S10029 crush sleeves from sleeve bag D3ISL. Insert the new S10029 crush sleeves into the previously installed poly bushings in the new upper control arms.

20. Locate (4) sert fitting that where packaged with the installer copy of the instruction sheet. Carefully install the sert fittings into each end of the new lower control arms. **Special note: Take special care not to damage the sert fittings during installation.**

21. Locate the stock upper control mounting hardware that was removed in step # 10. Working on the driver side, install the new upper control arm into the stock frame mount location and the axle mount location and secure using the stock hardware. **Make sure to use thread locker or lock tite. Do not fully tighten at this point. Special note: Raising the axle to ride height and moving the axle up and down will help make installation of the new upper control arm a little easier. Slight prying of the stock control arm bracket also may be needed to make installation easier.** Repeat procedure on passenger side.

Illustration # 5

22. Move back to the stock upper and lower control arm hardware and torque to **85 ft lbs.** **Special note: On the stock axle mount hardware on the new lower control arms make sure that the alignment marks that were made in step # 5 are still lined up.**

If the vehicle that you are working on was manufactured before 09/01/99 skip to step # 32

If the vehicle that you are working on was manufactured after 09/01/099 follow step # 23 — 31

23. Locate the new lower control arms that are included in this suspension system. **Special note: The new lower control arms are the longer arms that are included in this suspension system.** Also, locate (8) PB2408 poly bushings from poly bag D3IPL. Insert the new poly bushings into each end of the new lower control arms. **Special Note: Make sure to use a lithium or moly base grease prior to inserting the new bushings into the new lower control arms. This will increase the life of the bushing as well as prevent squeaking.**

24. Locate (4) new S10043 crush sleeves from sleeve bag D5ISL. Insert the new S10043 crush sleeves into the previously installed poly bushings in the new lower control arms.

25. Locate (4) sert fitting that where packaged with the installer copy of the instruction sheet. Carefully install the sert fittings into each end of the new lower control arms.

Special note: Take special care not to damage the sert fittings during installation.

26. Locate the stock lower control mounting hardware that was removed in step # 11. Working on the driver side, install the new lower control arm into the stock frame mount location and secure using the stock hardware. **Make sure to use thread locker or lock tite. Do not fully tighten at this point.** On the stock front bolt that connects the new lower control arm to the stock front bracket, refer to the reference marks that were made in step # 4 and re-install into the same location. **Make sure to use thread locker or lock tite. Do not fully tighten at this point. Special note: Raising the axle to ride height and moving the axle up and down will help make installation of the new lower control arm a little easier. Slight prying of the stock control arm bracket also may be needed to make installation easier.** Repeat procedure on passenger side.

Illustration # 4

27. Locate the new upper control arms. **Special note: The new upper control arms are the shorter arms that are included in this suspension system.** Also, locate (8) PB2408 poly bushings from poly bag D3IPL. Insert the new poly bushings into each end of the new upper control arms. **Special Note: Make sure to use a lithium or moly base grease prior to inserting the new bushings into the new upper control arms. This will increase the life of the bushing as well as prevent squeaking.**

28. Locate (4) new S10042 crush sleeves from sleeve bag D5ISL. Insert the new S10042 crush sleeves into the previously installed poly bushings in the new upper control arms.

29. Locate (4) sert fitting that where packaged with the installer copy of the instruction sheet. Carefully install the sert fittings into each end of the new lower control arms. **Special note: Take special care not to damage the sert fittings during installation.**

30. Locate the stock upper control mounting hardware that was removed in step # 10. Working on the driver side, install the new upper control arm into the stock frame mount location and the axle mount location and secure using the stock hardware. **Make sure to use thread locker or lock tite. Do not fully tighten at this point. Special note: Raising the axle to ride height and moving the axle up and down will help make installation of the new upper control arm a little easier. Slight prying of the stock control arm bracket also may be needed to make installation easier.** Repeat procedure on passenger side.

Illustration # 5

31. Move back to the stock upper and lower control arm hardware and torque to **85 ft lbs.** **Special note: On the stock axle mount hardware on the new lower control**

arms make sure that the alignment marks that were made in step # 5 are still lined up.

32. Locate the new upper coil spring spacers and the stock rubber isolator pads that were removed in step # 13. Insert the stock rubber isolator pads inside the recess in the new upper coil spring spacer.

33. Working on the driver side, place the new upper coil spring spacer on the top of the stock coil spring and insert the stock coil spring into the stock lower location. **Special note: Make sure that the marks that were scribed in step # 6 line up with each other.** Repeat procedure on the passenger side. Carefully raise up on both hydraulic floor jacks at the same time until the driver side and passenger side new upper coil spring spacers and stock coil springs seat properly into the stock upper location. **Special note: There is (1) 3/8" x 1 1/2" bolt that is welded to the new upper coil spring spacer, this bolt needs to be line up with the back side stock hole. This will make installation easier to tighten the new nut down.**

34. Locate the new front shocks. **Special note: New longer front shocks are needed once this suspension system has been installed and the front shocks need to be ordered as a separate part #. If you have not already ordered your new front shocks, please feel free to contact Tuff Country or your local Tuff Country dealer and order your new front shocks. Tuff Country recommends installing a 26" fully extended nitrogen gas shock in the front end of your vehicle.** Locate (2) new 3/8" x 1 1/2" fender washers from hardware bag D31NB. Also, locate (2) PB8297 front upper shock bushings that were packaged with the installer copy of the installation manual. Install the new bushings and proper sleeves into each end of the new shocks. **Special note: The new bushings and sleeves are supplied with your new shocks. Also, make sure to use a lithium or moly base grease prior to inserting the new bushings and sleeves into the new shocks. This will increase the life of the bushings and will help prevent squeaking.** Install the new shock boots onto the new shocks. **Special note: The new shock boots are not included with this suspension system and the new shock boots need to be ordered as a separate part #. If you have not already ordered your new shock boots, please feel free to contact Tuff Country or your local Tuff Country dealer and order your new shock boots.** Once the new shock boots have been installed, working on the driver side, install the new shock into the stock coil spring by inserting it through the engine compartment. Install the new fender washer and the new front upper shock bushing onto the stud of the new shock. Repeat procedure on the passenger side.

35. Locate the stock lower shock mounting hardware that was removed in step # 9. Working on the driver side, secure the newly installed front shock into the stock lower

location and secure using the stock hardware. **Make sure to use thread locker or lock tite.** Do not tighten at this point. Repeat procedure on the passenger side.

36. Locate the stock upper shock tower brackets that were removed in step # 8. Locate (2) new 3/8" x 1 1/2" fender washers from hardware bag D31NB. Locate (2) PB8297 front upper shock bushings that were packaged with the installer copy of the installation manual. Also, locate the new upper shock nut that was included with your new front shocks. Working on the driver side, install the stock upper shock tower to the new stud on top of the newly installed front shock. Now install the new front upper shock bushing and new 3/8" x 1 1/2" fender washer and secure the newly installed front shock to the stock upper shock bracket using the upper shock hardware. **Do not tighten at this point.** Repeat procedure on the passenger side.

37. Locate (4) 3/8" x 1 1/2" bolts, (10) 3/8" flat washers and (6) 3/8" nylon insert nuts and from hard bag D31NB. Working on the driver side, secure the new upper coil spring spacer to the stock upper coil spring tower and the stock upper shock tower using the new 3/8" hardware. **Make sure to use thread locker or lock tite.** Torque the new 3/8" hardware to **28 ft lbs.** Repeat procedure on the passenger side.

Illustration # 6

38. Working on the driver side, torque the stock lower shock bolt to **80 ft lbs** and the new upper shock nut to **22 ft lbs.** Repeat procedure on passenger side.

39. Locate the new track bar relocation bracket. Also, locate (2) 1/2" x 1 1/2" bolts (4) 7/16" USS flat washers and (2) 1/2" unitorque nuts from hardware bag D31NB. Working on the passenger side, place the new track bar relocation bracket on the outside of the stock track bar bracket keeping the new bracket flush with the bottom of the stock bracket. Clamp the new bracket into place. Using the (2) holes in the new bracket as a guide, carefully drill (2) 1/2" holes into the passenger side stock bracket. **Special note: When drilling the new holes make sure to drill straight through the existing bracket.** Secure the new bracket to the stock bracket using the new 1/2" x 1 1/2" bolt and hardware. Torque to **80 ft lbs.** Using the hole on the front of the newly installed track bar bracket as a guide, carefully drill a 1/2" hole into the front and back portion of the stock track bar bracket.

Illustration # 7

40. Locate the stock track bar mounting hardware that was removed in step # 4. Working on the passenger side, install the stock track bar into the newly installed track bar bracket and secure using the stock hardware. **Make sure to use thread locker or lock tite and torque to 75 ft lbs. Special note: If you are not able to install the stock track bar to the newly installed track bar bracket, you will have to perform this step with the weight of the vehicle on the ground.**

Illustration # 8

41. Locate the stock sway bar mounting hardware that was removed from step # 3. Working on the driver side, re-install the stock sway bar to the stock sway bar mounting point and secure using the stock hardware. **Make sure to use thread locker or lock tite and torque to 28 ft lbs. Special note: If you are not able to install the stock sway bar into the stock mounting location, you will have to perform this step with the weight of the vehicle on the ground.**

42. Carefully remove both hydraulic floor jacks from under the vehicle.

43. Check and double check to make sure that all steps were performed properly. Install the new tires and wheels on both the driver and passenger side and safely lower the vehicle to the ground.

44. If you were not able to install the stock track bar into the newly installed track bar relocation bracket in step # 40, perform step # 40 now that the weight of the vehicle is on the ground.

45. If you were not able to install the stock sway bar to the stock location in step # 41, perform step # 41 now that the weight of the vehicle is on the ground.

Front end installation complete.

Rear end installation;

46. To begin installation, block the front tires of the vehicle so that the vehicle is stable and can't roll forward. Safely lift the rear of the vehicle and support the frame with a pair of jack stands. Place a jack stand on both the driver and passenger side. Next, remove the wheels and tires from both sides.

47. Place a pair of hydraulic floor jacks under the driver and passenger side rear axle. Carefully raise up on both hydraulic floor jacks at the same time until they make contact with the rear axle.

48. Working on the driver side, remove the stock rear shock from the stock upper and lower location and save the stock hardware for later re-installation. The stock rear shock may be discarded. **Special note: New longer rear shocks are needed once this suspension system has been installed and the rear shocks need to be ordered as a separate part #. If you have not already ordered your new rear shocks, please feel free to contact Tuff Country or your local Tuff Country dealer and order your new rear shocks. Tuff Country recommends installing a 30" fully extended nitrogen gas shock in the rear.** Repeat procedure on the passenger side.

49. Working on the driver side, remove the stock rear u-bolts from the stock location. Set the stock rear u-bolts, stock u-bolt hardware, stock upper u-bolt plate and the

stock lower u-bolt plate aside for later re-installation. Repeat procedure on the passenger side.

50. Carefully lower down on both hydraulic floor jacks at the same time allowing enough room for the new rear add-a-leafs to be installed. **Special note: Take special care not to kink or over extend the stock rear brake line.**

51. Working on the driver side, place a pair of "C" clamp vise grips on each side of the stock centering bolt. Carefully remove the stock centering bolt and nut and discard. Carefully remove the "C" clamp vise grips that are holding the stock springs together. **Special note: Be very carefully when removing the "C" clamps, the stock springs are under tension and can be dangerous.** Repeat procedure on passenger side.

52. Locate the new rear add-a-leafs. Locate (2) 1/2" x 6" centering bolts & (2) 1/2" fine nuts from hardware bag CB12. Working on the driver side, install the new rear add-a-leaf into the stock spring assembly. Secure the new rear add-a-leaf to the stock spring assembly using the new 1/2" center bolt and nut. Torque to **42 ft. lbs.** **Special note: If the new rear add-a-leaf has an offset center hole location, place the longest side of the new rear add-a-leaf towards the rear of the vehicle. Also the new add-a-leaf should be installed into the stock spring assembly in progression in order, from longest to shortest. The new add-a-leaf should be installed between the stock overload and the stock spring pack. The stock overload is usually the un-arched spring at the bottom of the stock leaf pack. Also, Tuff Country EZ-Ride Suspension highly recommends NOT using any air tools when installing the new rear add-a-leafs into the stock spring assembly. If air tools are used the centering bolt may strip, causing the stock spring assembly to come apart.** With a suitable cutting tool, cut off the extra thread from the new centering bolt. Repeat procedure on passenger side.

Illustration # 9

53. Carefully raise up on both hydraulic floor jacks at the same time until the stock spring assembly sits flush with the newly modified stock springs.

54. Locate the stock rear u-bolts, stock u-bolt hardware, stock upper u-bolt plates and the stock lower u-bolts plates that were removed in step # 49. Working on the driver side, install the stock rear u-bolts into the stock location and secure using the stock u-bolt hardware. Torque to **85 ft lbs.** Repeat procedure on the passenger side.

55. Locate the new rear shocks. **Special note: New longer rear shocks are needed once this suspension system has been installed and the rear shocks need to be ordered as a separate part #. If you have not already ordered your new rear shocks, please feel**

free to contact Tuff Country or your local Tuff Country dealer and order your new rear shocks. Tuff Country recommends installing a 30" fully extended nitrogen gas shock in the rear end of your vehicle. Install the new bushings and proper sleeves into each end of the new shocks. **Special note: The new bushings and sleeves are supplied with your new shocks. Also, make sure to use a lithium or moly base grease prior to inserting the new bushings and sleeves into the new shocks. This will increase the life of the bushings and will help prevent squeaking.** Install the new shock boots onto the new shocks. **Special note: The new shock boots are not included with this suspension system and the new shock boots need to be ordered as a separate part #. If you have not already ordered your new shock boots, please feel free to contact Tuff Country or your local Tuff Country dealer and order your new shock boots.** Locate the stock rear shock hardware that was removed in step # 48. Working on the driver side, install the new shock into the stock upper and lower location. **Make sure to use thread locker or lock tite.** Torque the stock upper and lower hardware to **75 ft lbs.** Repeat procedure on the passenger side.

56. Carefully remove both hydraulic floor jacks from under the vehicle.

57. Check and double check to make sure that all steps were performed properly. Install the new tires and wheels on both the driver and passenger side and safely lower the vehicle to the ground.

Congratulations installation complete

Take vehicle directly to an alignment shop for a proper front end alignment

Tuff Country EZ-Ride Suspension recommends that a complete re-torque is done on all bolts associated with this suspension system. It is the customers responsibility to make sure that a re-torque is performed on all hardware associated with this suspension system after the first 100 miles of installation. It is also the customers responsibility to do a complete re-torque after every 3000 miles or after every off road use. Neglect of following these steps could cause brackets to come loose and cause serious damage to the suspension system and to the vehicle.

If you have any questions during installation, please feel free to call our tech line. (801) 280—2777. Our business hours are Monday — Friday from 8:00 a.m. — 6:00 p.m. MST.

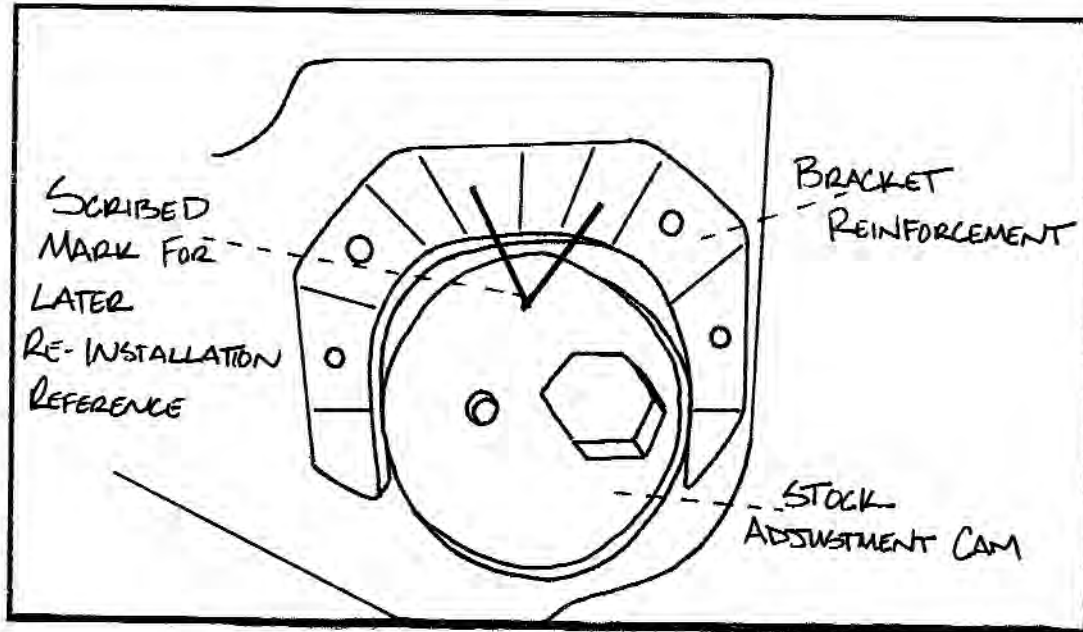

ILLUSTRATION # 1

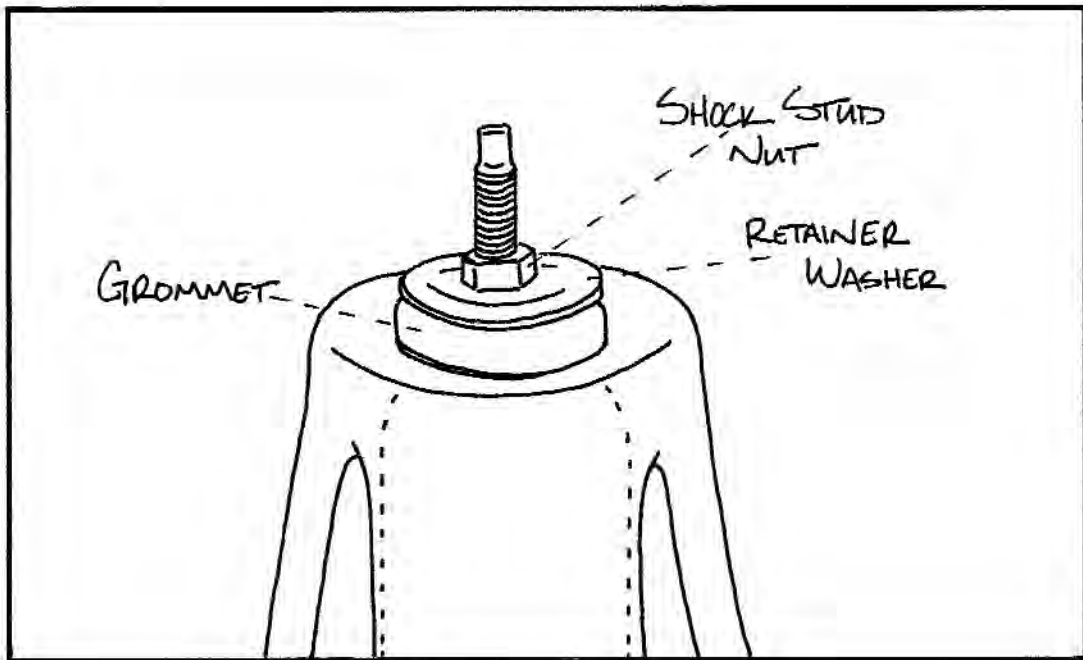

ILLUSTRATION # 2

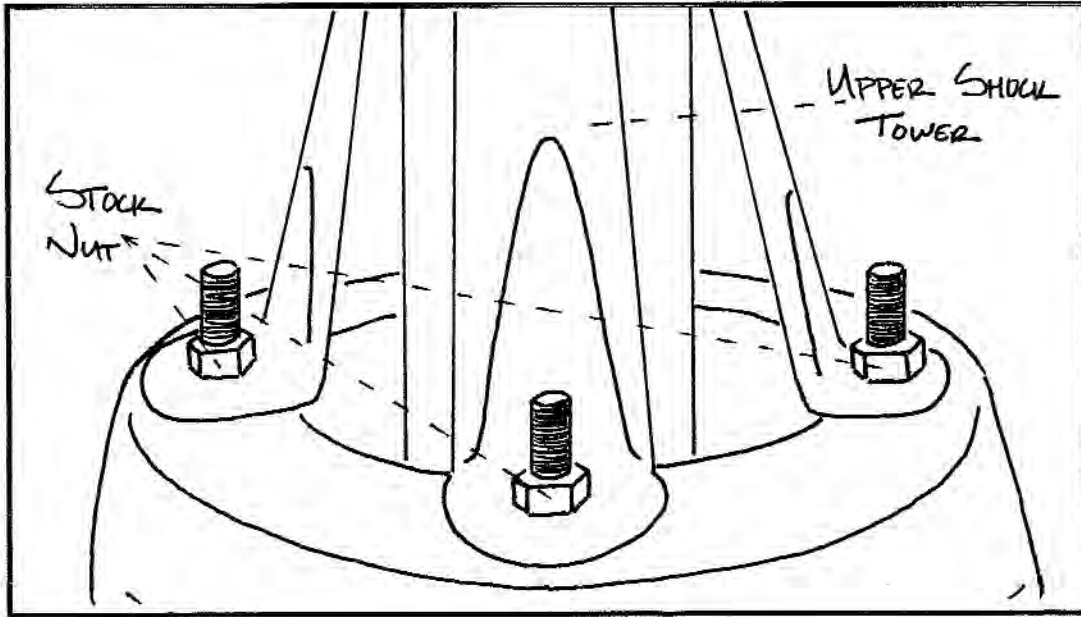

ILLUSTRATION # 3

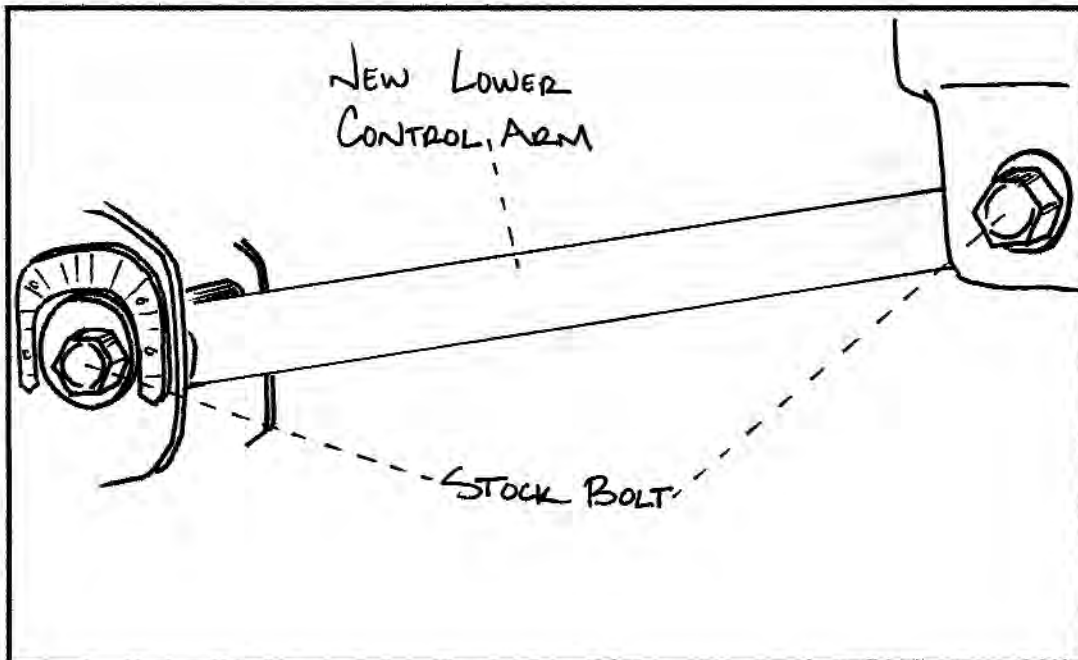

ILLUSTRATION # 4

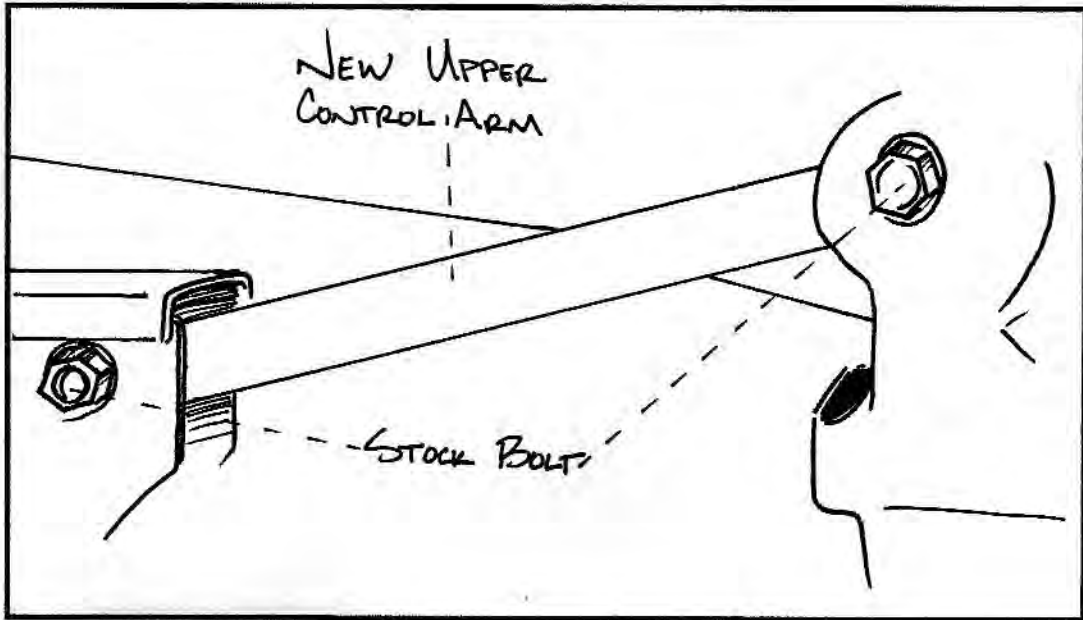

ILLUSTRATION # 5

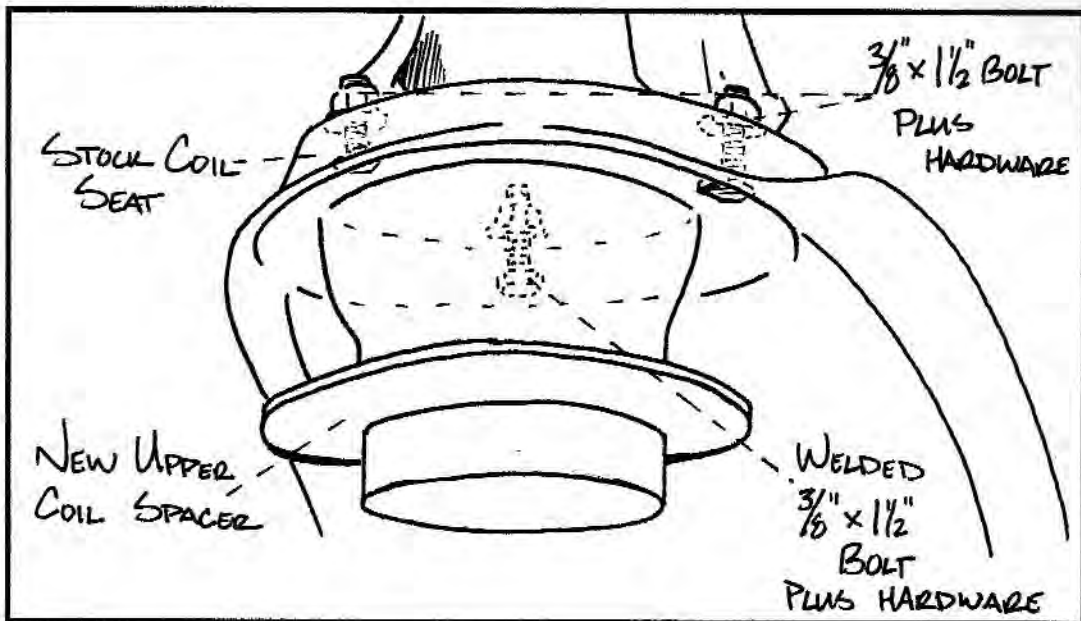

ILLUSTRATION # 6

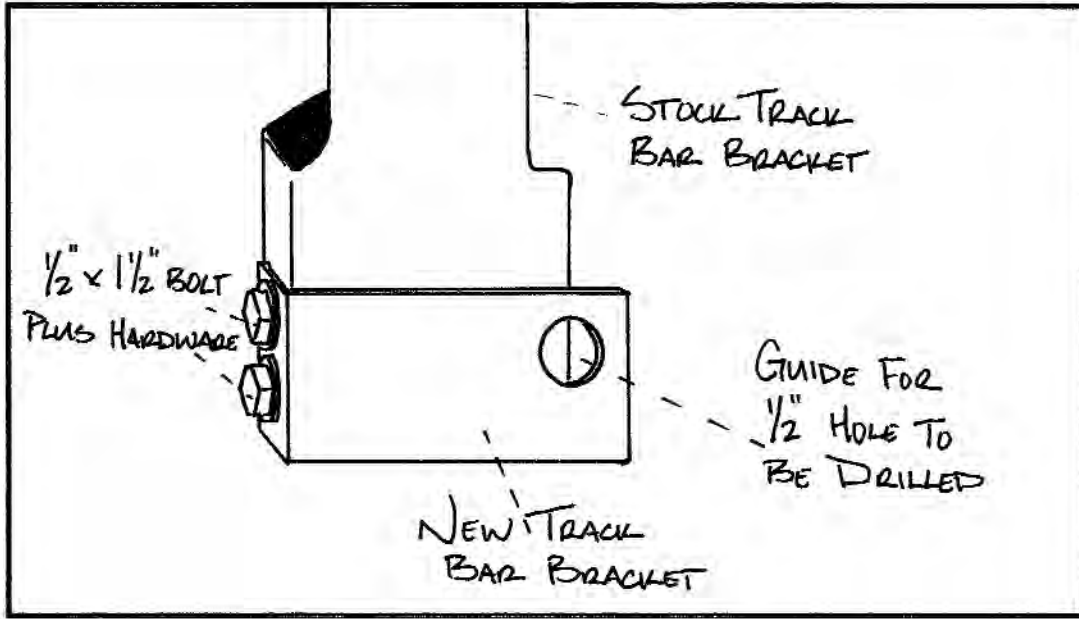

ILLUSTRATION # 7

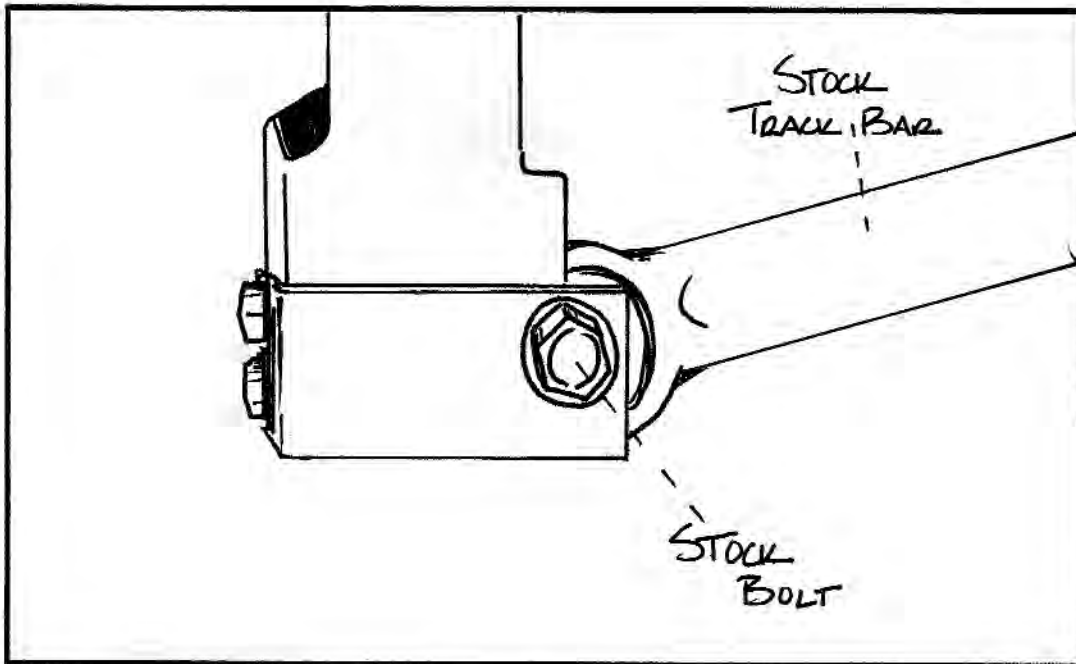

ILLUSTRATION # 8

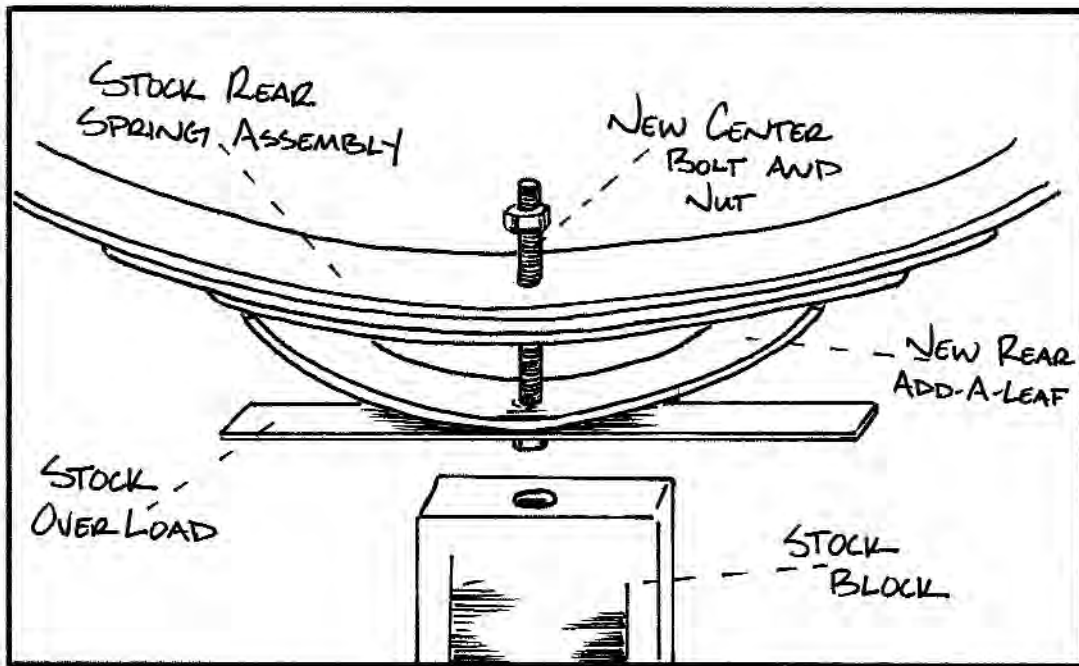
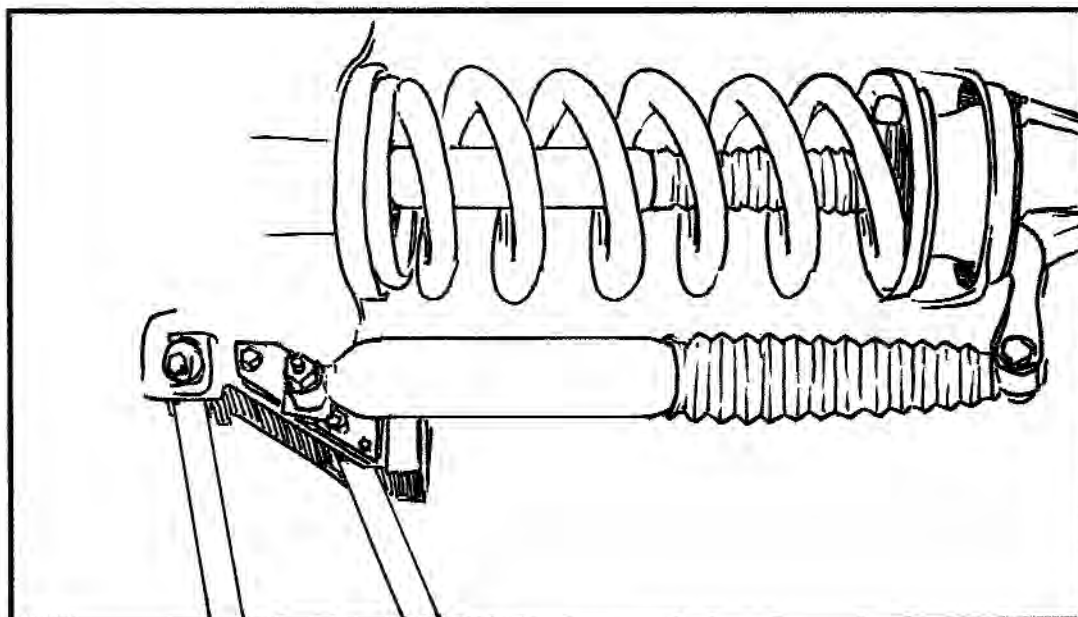

ILLUSTRATION # 9



Driver Side Front Complete Assembly
With Optional Dual Shock Kit
→ Top of Vehicle