



TUFF COUNTRY

EZ-RIDE SUSPENSION

OLD PART NO. C611N (6 LUG) / C612N (8 LUG)
 NEW PART NO. 16813 (6 LUG) / 16823 (8 LUG)
 G.M. 6" I.F.S. SUSPENSION LIFT
 PARTS LIST:

Qty.	Description	Part No.
1	Steering Center Link	C6I-103
1	Steering Assist	C4I-104
1	Driver Side Upper Control Arm Drop Bracket (1/2 Ton Only)	C6I-105
1	Passenger Side Upper Control Arm Drop Bracket (1/2 Ton Only)	C6I-106
1	Driver Side Upper Control Arm Drop Bracket (3/4 Ton Only)	C6I-205
1	Passenger Side Upper Control Arm Drop Bracket (3/4 Ton Only)	C6I-206
1	Driver Side Upper Differential Drop	C6I-109
1	Passenger Side Upper Differential Drop	C6I-110
2	Torsion Bar Drop Blocks	C4I-111
1	6" Sub Frame	C6I-113
2	Rear Lateral Compression Mounts	C6I-116
2	Lateral Compression Arms (1/2 Ton)	C6I-111
2	Lateral Compression Arms (3/4 Ton)	C6I-211
1	Poly Bag	C6I-NB1
1	Hardware Box	16813NB
1	Sleeve Bag	C6ISL
2	3" Lifted Blocks	BL301
2	Rear Add-A-Leafs	TCI-R25
1	3/8" Centering Bolts and Nuts	CB38
4	9/16" x 2 3/4" x 14 5/8" Square "U" Bolts (1/2 Ton Only)	5U-9295S
1	9/16" High Nuts & Washers	916NW
4	5/8" x 2 3/4" x 14 5/8" Square "U" Bolts (3/4 Ton Only)	5U-9296S
1	5/8" High Nuts & Washers	58NW
8	Cam Washers	CAM-02
4	9/16" x 4" Cam Bolts	CAM-03
4	9/16" Unitorque Nuts	916UN
1	Brake Line Extension Brackets	C46IBL
6	2" x 2" Square Washers	22SW
2	9/16" x 3 5/8" Sleeve With Welded Washers	916356WW
2	Sert Fittings	SERT
2	Clevis Mounts	P98
1	Instruction Sheet	14813-INST

***Important Notes:** Please read before beginning installation. OEM Manual should be used as a reference.

TUFF COUNTRY SUSPENSION highly recommends a qualified and or certified mechanic to perform this installation.

Product safety label must be installed inside the cab in plain view of all occupants.

INSTALLATION MANUAL G.M. 6" I.F.S. SUSPENSION 1988 - 1998

PART # 16813 / C611N
 K1500 & K2500 (6 LUG)
 PART # 16823 / C612N
 K2500 & K3500 (8 LUG)

SJ012201

WARNING: TUFF COUNTRY EZ-RIDE SUSPENSION HIGHLY RECOMMENDS THAT A CERTIFIED MECHANIC PERFORM'S THIS INSTALLATION.

Congratulations on your selection to purchase a Tuff Country Suspension System. We at Tuff Country are proud to offer a high quality product at the industries most competitive pricing. Thank you for your confidence in us, and our product.

Read and understand all sections of installation manual.

Use locktite on all bolts associated with this installation.

Important Customer Information

General Motors has introduced a new transfer case option that uses the name "Auto-Trac". Auto Trac is a full time 4WD system. This option pertains to the Tahoe (2 or 4 door), Suburbans and some of the pick ups. To identify this, see the transfer case selection panel located on the dash board. Below the 2HI button it will read AUTO 4WD. Vehicle with Auto Trac may encounter a front drive shaft vibration when the lift kit is installed. If this is the case with the vehicle that you are working on Tuff Country offers a drive line that will take care of the vibration. Please feel free to contact us at (800) 288 - 2190 or visit your local Tuff Country Dealer and order part number C9598DL.

On 1998 GMC/Chevy vehicles you must order an axle extension kit, Part No. 9801B for 6 lug vehicles and a 9802B for 8 lug vehicles.

Front end alignment will be required

Exhaust modification is required.

WARNING

If you desire to return vehicle to stock make sure to save all stock components

IMPORTANT CUSTOMER INFORMATION

This vehicles reaction and handling characteristics may differ from standard cars and/or trucks. Modifications to improve and or enhance off road performance may raise the intended center of gravity. Extreme caution must be utilized when encountering driving conditions which may cause vehicle imbalance or loss of control. Drive Safely! Avoid abrupt maneuvers, such as sudden sharp turns which could cause a roll over, resulting in serious injury or death.

It is the customers responsibility to make sure a re-torque is performed on all hardware associated with this suspension system after the first 100 miles of installation. It is also the customers responsibility to do a complete re-torque after every 1000 miles or after every off road use.

After the original installation, Tuff Country also recommends having the alignment checked every 6 months to ensure proper tracking, proper wear on tires and front end components. Tuff Country takes no responsibility for abuse, improper installation, or improper suspension maintenance.

IMPORTANT NOTICE

DO NOT install a body lift in combination with a suspension system. If a body lift is used in conjunction with any Tuff Country Suspension product, your Tuff Country WARRANTY WILL BE VOID.

NOTICE

It is the responsibilty of the customer or the mechanic to wear safety glasses at all times when working with air tools.

Torque Settings:

5/16"	15-18 ft. lbs.	3/8"	28-32 ft.lbs.
7/16"	30-35 ft. lbs.	1/2"	65-85 ft. lbs.
9/16"	75-90 ft. lbs	5/8"	85-110 ft. lbs.
3/4"	105-125 ft. lbs.		

Please Follow Instruction Carefully

Before installation begins, drive and check to make sure there are not any uncommon sounds and or frame damage. Also at this time measure from the center of the hub to the bottom of fender well, and record measurements below.

Pre Installation Measurements:

Driver Side Front _____
Passenger Side Front _____
Driver Side Rear _____
Passenger Side Rear _____

At the end of the installation take the same measurements and compare to the pre installation measurements.

Post Installation Measurement:

Driver Side Front _____
Passenger Side Front _____
Driver Side Rear _____
Passenger Side Rear _____

Please following instructions carefully.

Front End Installation:

1. To begin installation, block the rear tires of the vehicle so that the vehicle is stable and can't roll backwards. Safely lift the front of the vehicle and support the frame with jack stands. Place a jack stand on both the driver and the passenger side. Next remove the wheels and tires from both sides.
2. Working on the driver side, remove the inner rubber fender splash guard and save for later re-installation. Repeat procedure on passenger side.
3. Remove the differential skid plate. **Also at this time remove the front drive line, and save for later re-installation.**
4. Measure exposed threads on torsion bar adjustment bolt and record here for later reference.
Record measurement here: _____
See Illustration # 1
5. Working on the driver side, attach the torsion bar removing tool, making sure that the unloading bolt in the center tool is in the small divot of the torsion bar key. Adjust torsion bar key up high enough to remove the small metal adjusting block and the bolt from the cross member. Save hardware for later re-installation. Repeat procedure on passenger side.
See Illustration # 2

6. Mark both torsion bars before removal so that they can be re-installed back into the stock location. **Example: Driver vs. passenger and front vs. rear.** Tap torsion bars forward until torsion bar cross member can be removed.

7. Working on the driver side, remove the (3) stock bolts that hold the stock torsion bar cross member to the stock location and discard hardware. Repeat procedure on passenger side. Slide stock torsion bar cross member out by moving driver side rearward and passenger side forward. Set stock torsion bar cross member aside for later re-installation.

8. Working on the driver side, slide the stock torsion bar out of the stock lower rear control arm and set aside for later re-installation. Repeat procedure on passenger side.

9. Working on the driver side, remove the front stock shock and save hardware for later re-installation. Repeat procedure on passenger side. Stock shocks may be discarded, new shocks are needed.

10. Working on the driver side, remove the stock brake line bracket from the stock upper control arm bracket and save hardware for later re-installation. Repeat procedure on passenger side.

11. Working on the driver side, remove the front sway bar end link from the stock sway bar and the stock lower control arm location. **Save hardware and end link for later re-installation.** Repeat procedure on passenger side. **Also at this time, invert the stock sway bar.**

12. Working on the driver side, locate the lower stock bracket that wraps around the rear part of the differential. Using a hacksaw or suitable cutting tool, cut off the stock bracket flush with the stock driver side rear lower control arm drop bracket. Unbolt the stock bracket from differential and discard stock bracket that was cut off. Save hardware for later re-installation. **Special Note: Tuff Country recommends not using a cutting torch when performing step # 12.**

See Illustration # 3

13. Working on the driver side, remove the stock cotter pin and castle nut from the outer steering knuckle. Save the stock hardware for later re-installation. Using a tie rod separating tool remove the outer tie rod end that is connected to the outer steering knuckle. Repeat procedure on passenger side. **Special Note: Take special care not to rip or tear stock tie rod boot.**

See illustration # 4

14. Working on the driver side, remove the cotter pin and castle nut from the pitman arm and save hardware for later re-installation. On the passenger side, remove the cotter pin and castle nut for the idler arm and save hardware for later re-installation.

15. Remove the stock center link from the stock location and lay on the ground in front of the vehicle. **Special Note:**

Chevy/GMC have a driver and a passenger side outer tie rod end. Make sure that when you re-install the new steering center link that you do not install the driver side outer tie rod end on the passenger side and the passenger side on the driver side.

16. With the stock center link on the ground, remove both inner cotter pins and castle nuts and set aside for later re-installation. Remove the driver and passenger side stock tie rod ends from the stock center link and save for later re-installation. **Special Note: Make sure to keep the driver side tie rod end on the driver side and the passenger side on the passenger side.**

17. Locate the new steering center link and secure to the idler arm and pitman arm. Secure using stock hardware. **Do not tighten at this point. Special Note: The lower spud on the new center link needs to go towards the rear of the vehicle.**

18. Working on the driver side, unbolt the six stock bolts that hold the inner CV joint to the differential. **Special Note: Before separating the CV from the differential, mark one bolt hole on CV plate and another directly across to the differential, this will allow you to re-install the CV in the same location at a later step.** Hang the CV from the lower control arms, using a wire taking care not to let CV's come apart. Repeat procedure on passenger side.

See Illustration # 5

19. Working on the driver side, remove the stock front lower control arm from the front stock location and save hardware for later re-installation. Repeat procedure on passenger

See Illustration # 6

20. Working on the driver side, remove the stock rear lower control arm from the rear stock location and save hardware for later re-installation. Repeat procedure on passenger.

See Illustration # 7

21. Place a hydraulic differential floor jack under the front differential and raise up on jack until jack makes contact with the front differential.

22. Working on the driver side, remove the stock upper bolt that holds the front differential into the stock upper location and save hardware for later re-installation. **Special Note: Driver side front upper stock mounting point is up high and difficult to see. Disconnect the differential's electronic coupler and vent hose. Save hardware for later re-installation.**

23. On the passenger side, remove the (2) stock bolts that hold the passenger side differential into the stock location and save hardware for later re-installation.

24. Ease off of jack stand and carefully lower the stock front differential approximately 6". **Special Note: During this procedure the front differential is being lower in relation to the frame. On some I.F.S. vehicles this can cause a**

clearance problem between the cooling fins on the differential and the bracket on the drivers side frame rail. If the cooling fins come in contact with the frame it may cause binding and damage to the differential housing. The differential also must be centered to allow the proper amount of inner CV joint plunge. When the cooling fins contact the frame, the differential is pushed to the passenger side. This causes the left axle to over extend causing the inner CV joint to pull out of the housing. When cooling fin contact occurs , the aluminum fins must be trimmed to allow the differential to center without contact to the frame. These fins are important for the cooling of the differential. When trimming the cooling fins you should only remove enough material to allow the clearance necessary.

Repeat procedure on passenger side.

See Illustration # 12

32. Working on the driver side, install the rear part of the new integrated cross member into the stock rear lower control arm drop pocket and secure using stock hardware removed from step # 20. **Do not tighten at this point.** Repeat procedure on passenger side.

See Illustration # 12

33. Working on the driver side, install the lower tab on the front differential into the newly installed integrated cross member and secure using stock hardware removed from step # 12. Torque to **80 ft. lbs.**

See Illustration # 13

25. **Driver Side Upper Differential Drop Bracket:** Locate the new driver side differential drop bracket, (1) 9/16" x 4" bolt, (2) 9/16" flat washers and (1) 9/16" unitorque nut. Working on the driver side, install the new driver side differential drop bracket into the upper stock location and secure using the new 9/16" x 4" bolt and hardware. **Do not tighten at this point.**

See Illustration # 8

26. **Passenger Side Differential Drop Bracket:** Locate the new passenger side differential drop bracket. Install the new passenger side differential drop bracket into the stock location and secure using the stock hardware. **Special Note: Make sure to use locktite on these bolts. Do not tighten at this point.**

See Illustration # 9

27. Carefully raise up on the hydraulic differential jack stand until the front differential seats properly with the new upper driver and passenger side differential drop brackets.

28. Working on the driver side, secure upper tab on the front part of the stock differential into the newly installed upper driver side differential drop bracket and secure using stock hardware removed in step # 22. **Do not tighten at this point.**

See Illustration # 10

29. Locate (2) 9/16" x 1 1/2" bolt, (4) 9/16" flat washers and (2) 9/16" unitorque nuts. Working on the passenger side, secure the passenger side of the differential to the newly installed passenger side differential drop bracket and secure using the new 9/16" x 1 1/2" bolt and hardware. **Do not tighten at this point.**

See Illustration # 11

30. Remove the hydraulic differential floor jack.

31. Locate the new one piece integrated front and rear cross member. On the driver side, install the front part of the new integrated cross member into the stock front lower control arm drop pocket and secure using stock hardware removed from step # 19. **Do not tighten at this point.**

34. Locate (2) 1/2" x 1 1/2" bolts, (2) 1/2" unitorque nuts and (4) 1/2" flat washers. Using the holes in the front part of the new integrated cross member as a guide, drill (2) 1/2" holes into the frame. Secure using new 1/2" bolts and hardware. **Do not tighten at this point.**

See Illustration # 14

35. Locate poly bag marked C6I-NB1. Locate the (6) poly bump stops, (6) 3/8" lock nuts and (6) 3/8" flat washers. Working on the driver side, install (3) new poly bump stops into the newly installed integrated cross member lower rear location and secure using 3/8" hardware. Torque to **28 ft lbs.** Repeat procedure on passenger side.

See Illustration # 15

36. Locate (2) 5/8" x 4 1/2" bolts, (2) 5/8" x 5 1/2" bolts, (4) 5/8" unitorque nuts and (8) 5/8" flat washers. Working on the driver side, install the stock lower control arm into the newly installed integrated cross member front location and secure using new 5/8" x 4 1/2" bolt and hardware. **Do not tighten at this point.** Repeat procedure on passenger side.

See Illustration # 16

37. Install the stock lower control arm into the newly installed integrated cross member rear location and secure using new 5/8" x 5 1/2" bolt and hardware. **Do not tighten at this point.** Repeat procedure on passenger side.

See Illustration # 17

38. Move back to all the bolts associated with the new differential and tighten the stock and the new bolts to proper torque specifications. Refer to the torque sheet on page 2. **Special Note: Make sure that when you are torquing these bolts that you get the differential centered. This will allow for proper amount of inner CV joint engagement.**

39. Move back to all the bolts associated with the new integrated cross member. Tighten the stock bolts that connect the new integrated cross member to the stock location and torque to proper specifications. Refer to the torque sheet on page 2. Also at this time torque the new 1/2" bolts and hardware that connect the integrate cross

member to the bottom of the frame.

40. Working on the driver side, torque the newly installed 5/8" bolts that connect the lower control arm to the newly installed integrated cross member front and rear location and torque to 110 ft lbs. Repeat procedure on passenger side.

41. Working on the driver side, support the stock lower control arm, remove the stock cam bolts from the stock upper control location and save hardware for later re-installation. Let hang. Repeat procedure on passenger side.

42. On both sides of the frame near the stock upper control arm mounts, unbolt the stock rubber compression bump stops from their steel frame mount brackets and discard. With a suitable cutting tool carefully trim the steel frame mount bump stop brackets, flush with the frame on the driver and passenger side allowing the new upper control arm drop brackets to mount flush to the frame. **Special Note: Do not cut or grind into the frame. CAUTION: UNDERCOATING IS FLAMMABLE. Also Tuff Country does not recommend using a torque when performing this step.** Grind and clean all cutting slag from the trimming performed in this installation step. Paint and under coat any exposed metal.

See Illustration # 18

43. **Upper Control arm Drop Brackets:** Locate the new driver and passenger side upper control arm drop brackets, (2) 3/4" x 9/16" x 4" anti crush sleeves, (2) 3/4" x 9/16" x 3 1/2" anti crush sleeves and (2) 3/4" x 9/16" x 3 5/8" anti crushed sleeve with welded washer. **Special Note: To determine the new driver side upper control arm drop bracket from the new passenger side upper control arm drop brackets the "S" sweep of the bracket goes toward the rear of the vehicle.** Working on the driver side, Temporarily bolt the new driver side upper control arm drop bracket into the stock location. Using an angle indicator to ensure that brackets sits perpendicular (90 degrees) to the frame. **If the bracket is not perpendicular, grind a little more where the bump stop was cut off ensuring that you do not cut or grind into the frame.** Once positioned, use the upper control arm drop bracket as a guide and drill (2) 1/2" holes through the frame. **Special Note: One hole is in the center on the new bracket and one hole is towards the front of the new bracket. There is an existing hole in the frame towards the back of the new bracket.** Now remove the new driver side upper control arm drop bracket and set aside. Enlarge the two previously drilled holes on the front of the frame only to 3/4" so that the anti crush sleeves can be inserted into the frame. The holes on the back side of the frame must remain at a 1/2". The holes on the back of the frame are only big enough for the bolts to protrude not the sleeve. Insert (1) 3/4" x 9/16" x 4" anti crush sleeve into the middle hole in frame. Insert (1) 3/4" x 9/16" x 3 1/2" anti crush sleeve into the front hole in the frame. **Special Note: On some 3/4 ton vehicles the**

front sleeve may need to be trimmed down about 3/16" so the bracket will sit flush with the frame. This is only need to be done on the driver side. Insert the new 3/4" x 9/16" x 3 5/8" anti crush sleeve with the welded washer into the rear hole in the frame. The sleeves are installed to prevent the frame from crushing when the bolts are torqued to specification during final assembly. Repeat procedure on passenger side.

44. Working on the driver side, install the new driver side upper control arm into the stock location and secure using stock cam bolts. **Do not tighten at this point.** Repeat procedure on passenger side.

See Illustration # 19

45. Locate (6) 1/2" x 5 1/2" bolts, (6) 1/2" flat washers, (6) 1/2" unitorque nuts, (6) 2" x 2" square washers. Working on the driver side secure new driver side upper control arm to frame using (3) 1/2" x 5 1/2" bolts and hardware. **Special Note: The square washers will be installed on the inside of frame. Caution: On 8 lug 3/4 and 1 tons the driver side front 1/2" x 5 1/2" bolt may come into contact with the steering box. If this occurs trim the bolt on threaded side flush with nut.** Torque to 85 ft lbs. Repeat procedure on passenger side.

See Illustration # 20 Outside of Frame

See Illustration # 21 Inside of Frame

46. Locate (4) 9/16" x 4" cam bolts, (8) cam washers and (4) 9/16" unitorque nuts. Working on the driver side install the stock upper control arm into the newly installed upper control arm drop bracket and secure using (2) 9/16" x 4" cam bolt and hardware. **Special Note: Center the cam bolt and tighten to 90 ft lbs. Alignment shop will set proper alignment specs.** Repeat procedure on passenger side.

See Illustration # 22

47. Locate (2) new torsion bar drop blocks, (10) 7/16" x 1 1/2" bolts, (2) 7/16" x 2 1/2" bolts, (24) 7/16" flat washers and (12) 7/16" unitorque nuts. Working on the driver side of the stock torsion bar cross member that was removed in step # 7 install the new torsion bar drop block to the stock torsion bar cross member and secure using (1) 7/16" x 2 1/2" bolt and hardware in the bottom center hole. Use (2) 7/16" x 1 1/2" bolt and hardware on the outer 2 bottom holes. Torque to 35 ft lbs. **Special Note: Install the stock torsion bar cross member to the inside of the new torsion bar drop block.** Repeat procedure on passenger side.

48. Locate the driver side torsion bar that was removed in step # 8. Install the stock torsion bar into in the stock lower control arm. Make sure that you push the stock torsion bar as far forward so that the stock torsion bar cross member can be installed. **Special Note: Make sure that you install the stock torsion bar the way it was removed. Example: driver vs. passenger and front vs. rear.** Repeat procedure on passenger side.

49. Working on the driver side, install the stock torsion bar cross member and the newly installed torsion bar drop blocks to the stock location on the bottom of the frame rail and secure using (3) new 7/16" x 1 1/2" bolts and hardware. Torque to 35 ft lbs. Repeat procedure on passenger side.

See Illustration # 23

50. Working on the driver side, re-install the stock torsion bar adjusting key into the stock location in the stock torsion bar cross member. Re-install the stock torsion bar into the stock location in the stock torsion bar key. Repeat procedure on passenger side.

51. Locate the outer tie rod ends that were removed in step # 16. Working on the driver side, install the stock outer tie rod end to the stock steering knuckle and secure using stock castle nut and cotter pin. Torque to 95 ft lbs. Repeat procedure on passenger side. **Special Note: Make sure that the driver side outer tie rod end is installed on the driver side and the passenger side outer tie rod end is installed on the passenger side.**

See Illustration # 24

52. Working on the driver side, install the outer tie rod end to the newly installed steering center link and secure using stock castle nut. **Do not tighten at this point.** Repeat procedure on passenger side.

See Illustration # 25

53. **Steering Assist:** Locate the new steering assist, (4) MO205 poly bushings, (2) 9/16" x 2 1/8" crush sleeve with hole drilled in the center, (2) sert fittings, (2) 9/16" x 3" bolts and (2) 9/16" flat washers. Install the new poly bushings into the new steering assist unit (2) per end. **Special Note: Make sure to use a lithium or moly base grease prior to inserting bushings into new steering assist. This will increase the life of the bushing as well as prevent squeaking.** Install the new anti crush sleeves into each end of the new steering assist. The new steering assist unit has pre drilled holes in each end of it, install the new sert fittings in these holes. Secure new steering assist to newly installed integrated cross member and newly installed center link using the new 9/16" x 3" bolt and washers. **Special Note: When torquing new assist, to newly installed integrated cross member and center link, the best way is to start on the idler arm and make a few turns on the nut, then work towards one of the tie rod ends, then move to the pitman arm, then to the other tie rod end, then move to the 9/16" bolts and continue in a circular movement until center link and assist is tight.**

See Illustration # 26

54. Locate (2) front brakeline extending brackets (4) 5/16" x 1" bolts, (8) 5/16" flat washer and (4) 5/16" unitorque nuts. Working on the driver side, install (1) new brakeline bracket into the rear stock location of the stock upper control arm pocket. **Hole already provided.** Secure using 5/16" hardware. Next install stock brakeline bracket to newly installed brakeline bracket and secure using 5/16"

hardware. Repeat procedure on passenger side.

See Illustration # 27

55. Working on the driver side, re-connect the front sway bar end links to the stock sway bar and to front part of the stock lower control arm and secure using stock hardware. Repeat procedure on passenger side. **Special Note: Make sure that you inverted the stock sway bar in step # 11**

56. Working on the driver side, re-connect the stock CV plate to differential using stock hardware that was removed in step # 18. **Special Note: Make sure that the marks previously made in step # 18 line up with each other. Also make sure to use locktite on the stock bolts.** Repeat procedure on passenger side. Torque to 30 ft. lbs

57. Working on the driver side, attach the torsion bar removing tool, making sure that the unloading bolt in the center tool is in the small divot of the torsion bar key. Adjust torsion bar key up high enough so that the small metal adjusting block and bolt can be re-installed. Refer back to step # 4 and adjust the bolt to the stock location. Repeat procedure on passenger side.

58. Move back to all newly installed brackets and make sure that all the hardware is torque to proper specifications. Now re-connect the front differential's electronic coupler and vent hose. **Special Note: Refer to torque sheet and torque to proper settings. Check and double check to make sure bolts are tight.**

59. Locate (2) 5/8" x 2 1/2" poly shock bushing, (2) 1/2" x 2 1/2" shock sleeve. Insert new poly shock bushings into the upper eyelet of the new shocks. **(Shock not include with this suspension system, shocks need to be ordered as a separate part number, Tuff Country recommends using a 23" fully extended nitrogen gas shock).** Install the new crush sleeve into newly installed upper shock bushings and install new shock into stock location and secure using stock hardware. Repeat procedure on passenger side. **Re-install inner rubber fender splash guard on the driver and passenger side.**

60. Locate (2) rear lateral compression mounts, (2) spacer sleeve, (2) 1/2" x 2 1/2" bolts, (4) 1/2" washers and (2) 1/2" unitorque nuts. Working on the driver side, install the rear lateral compression mount to the on the stock upper rear cross member located straight back from the newly installed lower sub frame. Secure using (1) 1/2" x 2 1/2" bolt, (2) 1/2" flat washers, (1) 1/2" unitorque nut and (1) 9/16" x 1 1/4" anti-crushed sleeve. **Do not tighten at this point. Special Note: The 9/16" x 1 1/4" anti crush sleeve needs to go into the stock cross member, this will allow the cross member not to crush when the bolt is torqued.** Repeat procedure on passenger side.

See Illustration # 28

61. Locate (2) lateral compression arms, (8) poly bushings, (4) 9/16" x 2 1/8" anti crush sleeves. **Special Note: For the**

1/2 ton vehicles the lateral compression arms should measure out at 29 1/2", on the 3/4 and 1 ton vehicles the lateral compression arm should measure out at 32 1/2" inches). Insert the new poly bushing into each end of the new lateral compression arms. **Make sure to use a lithium or moly base grease, this will help on the life of the bushing and also help prevent any squeaking.** Insert the new sleeves into the newly installed poly bushing at each end of the new lateral compression arm.

62. Working on the driver side, install the new lateral compression arm to the newly installed lower sub frame and secure using the new 1/2" x 3 1/2" bolt and hardware. **Do not tighten at this point.** Next, install the new lateral compression arm to the newly installed rear lateral compression arm mount and secure using new 1/2" x 3 1/2" bolt and hardware. Torque to **70 ft lbs.** Repeat procedure on passenger side.

See Illustration # 29

63. Check and double check to make sure that all steps were performed properly and that all hardware, stock and new, has been torqued to proper specification.

64. Re-install the tires and wheels and safely lower the front of the vehicle to the ground.

Front End Installation Complete:

Rear End Installation:

65. To begin installation, block the front tires of the vehicle so that the vehicle is stable and can't roll forward. Safely lift the rear of the vehicle and support the frame with jack stands. Place a jack stand on both the driver and the passenger side. Next remove the wheels and tires from both sides.

66. Locate (1) rear brakeline extending bracket, (1) 5/16" x 1" bolt, (2) 5/16" flat washer and (1) 5/16 unitorque nut. Remove the stock brakeline bracket from the rear differential and save stock bolt for later re-installation. Secure new brakeline bracket to rear differential housing using the stock bolt. Attach the stock brakeline bracket to the newly installed brakeline bracket and secure using the new 5/16" hardware.

See Illustration # 30

67. Position a pair of hydraulic floor jacks under the rear axle. Place one jack stand on the driver side and one on the passenger side. Raise up on both floor jacks at the same time until they make contact with the rear axle.

68. Working on the driver side, remove the stock shock and save hardware for later re-installation. Longer shocks are needed so the stock shock may be discarded. Repeat procedure on passenger side.

69. Working on the driver side, remove the (2) stock rear U-bolts and discard. Repeat procedure on passenger side.

70. Lower down on both hydraulic floor jacks at the same time until the stock springs separate from the axle. Lower down on hydraulic floor jacks approximately 5". This will allow enough room for the new rear blocks and add-a-leaves to be installed.

71. Locate (2) new rear add-a-leaves, (2) 3/8" centering bolt and nuts. Working on the driver side place a pair of "C" clamps around rear spring about 2" from the spring clamps. Safely remove stock centering bolt and discard. Install the new add-a-leaf to the stock spring assembly. Secure new add-a-leaf to the stock spring assembly using the new centering bolt and nut. **Special Note: The new add-a-leaf should be installed into the stock spring assembly in progression in order. The new add-a-leaf should be installed between the stock over load and spring assembly. The stock over load is usually the un-arched spring at the bottom of the leaf pack. Also Tuff Country recommends not using any air tools when installing new add-a-leaf into stock spring assembly. If air tools are used the centering bolt may strip.** Torque new centering bolt to 28 ft. lbs. Remove the "C" clamps from stock spring. With a suitable cutting tool, cut off the excess thread from the new centering bolt. Repeat procedure on passenger side.

See Illustration # 31

72. Locate (2) new 3" lifted blocks. Working on the driver side, install (1) new 3" lifted block between the stock rear axle and the stock spring assembly. **Special Note: The new 3" lifted block has a slight taper to it, the small end of the block needs to go towards the front of the vehicle.** Repeat procedure on passenger side.

See Illustration # 32

73. Raise up on both hydraulic floor jacks at the same time until the driver and passenger stock spring assembly seats flush with newly installed 3" lifted block.

If the vehicle that you are working on is a 6 lug please follow step # 74

If the vehicle that you are working on is a 8 lug please follow step # 75

74. Locate (4) new 9/16" x 2 3/4" x 14 5/8" Square U-bolts, (8) 9/16" high nuts and (8) 9/16" U-bolt washers. Working on the driver side, install (2) new 9/16" x 2 3/4" x 14 5/8" square U-bolts into the stock location and secure using new 9/16" high nuts and washers. **Torque to 95 ft. lbs.** Repeat procedure on passenger side.

See Illustration # 33

75. Locate (4) new 5/8" x 2 3/4" x 14 5/8" Square U-bolts, (8) 5/8" high nuts and (8) 5/8" U-bolt washers. Working on the driver side, install (2) new 5/8" x 2 3/4" x 14 5/8" square U-bolts into the stock location and secure using new 5/8" high nuts and washers. **Torque to 112 ft. lbs.** Repeat procedure on passenger side.

See Illustration # 34

76. Install the new rear shock absorbers. (Shock not include with this suspension system, shocks need to be ordered as a separate part number, Tuff Country recommends using a 30" fully extended nitrogen gas shock). Locate the new rear clevis mount and install into the new upper eyelet of the rear shock before installation.

77. Install the tires and wheels and safely lower the vehicle to the ground.

Check and double check to make sure all steps were performed properly. Check and double check to make sure all hardware is torqued to proper specs. Refer to torque settings on page 2.

CONGRATULATIONS INSTALLATION COMPLETE.

SPECIAL NOTE: AN EXHAUST MODIFICATION IS NEEDED. ALSO A FRONT END ALIGNMENT IS REQUIRED.

ONCE THE EXHAUST MODIFICATION HAS BEEN PERFORMED REPLACE THE STOCK FRONT DRIVE LINE BACK INTO THE STOCK LOCATION AND SECURE USING STOCK HARDWARE.

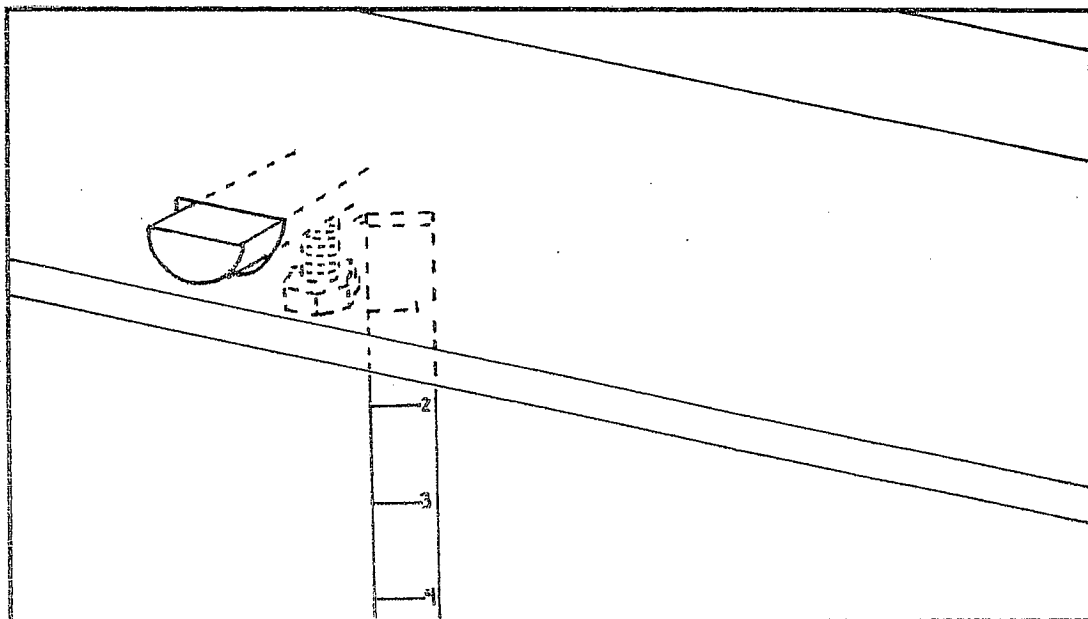

ILLUSTRATION # 1

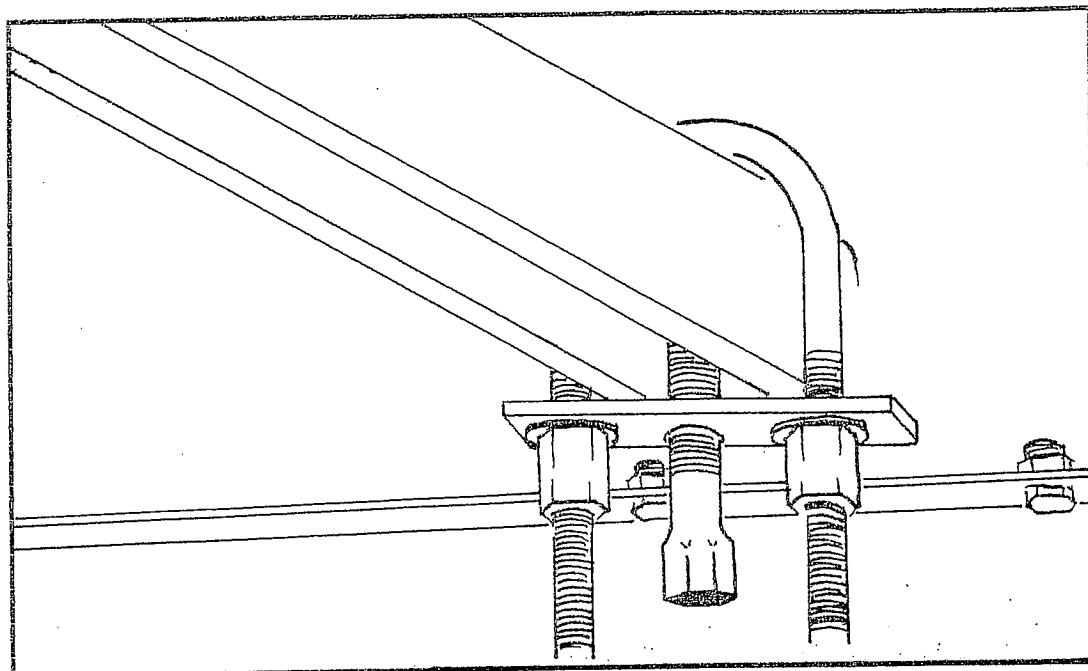

ILLUSTRATION # 2

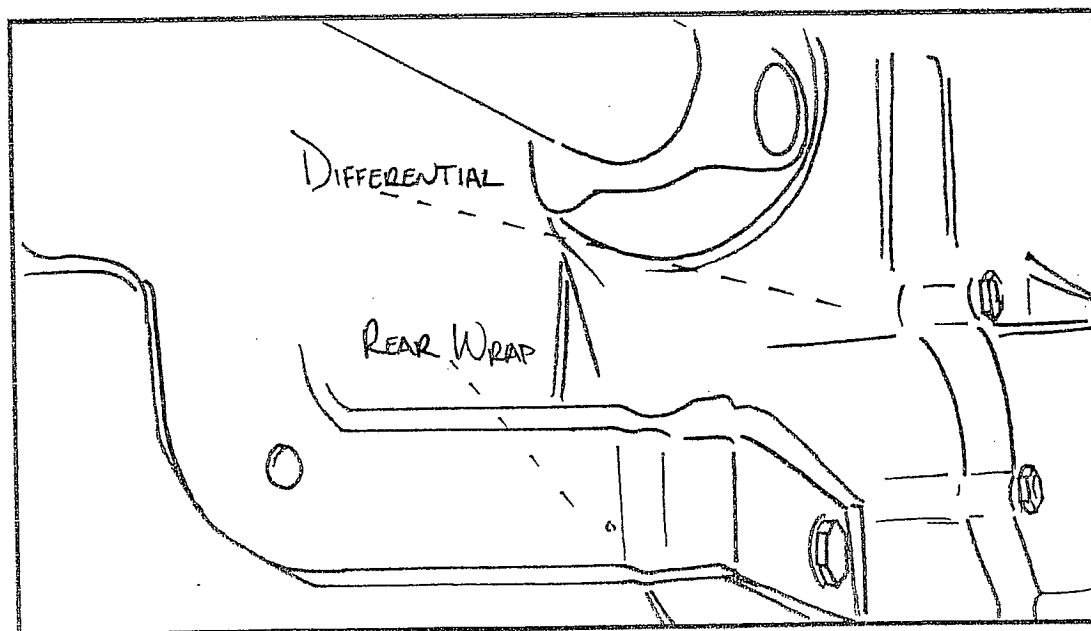

ILLUSTRATION # 3

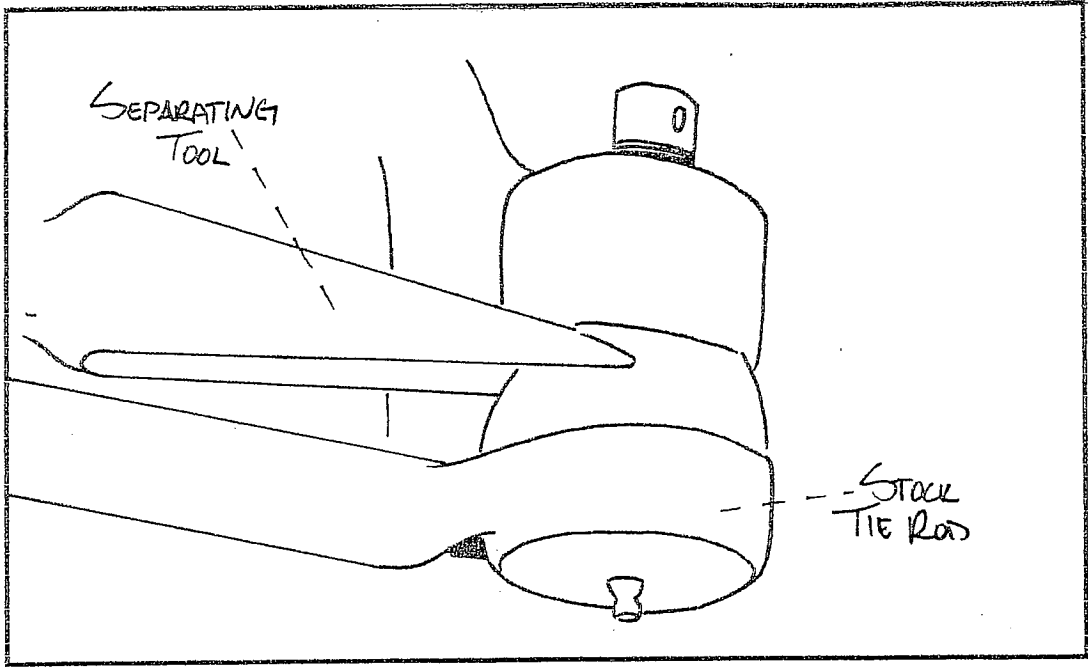

ILLUSTRATION # 4

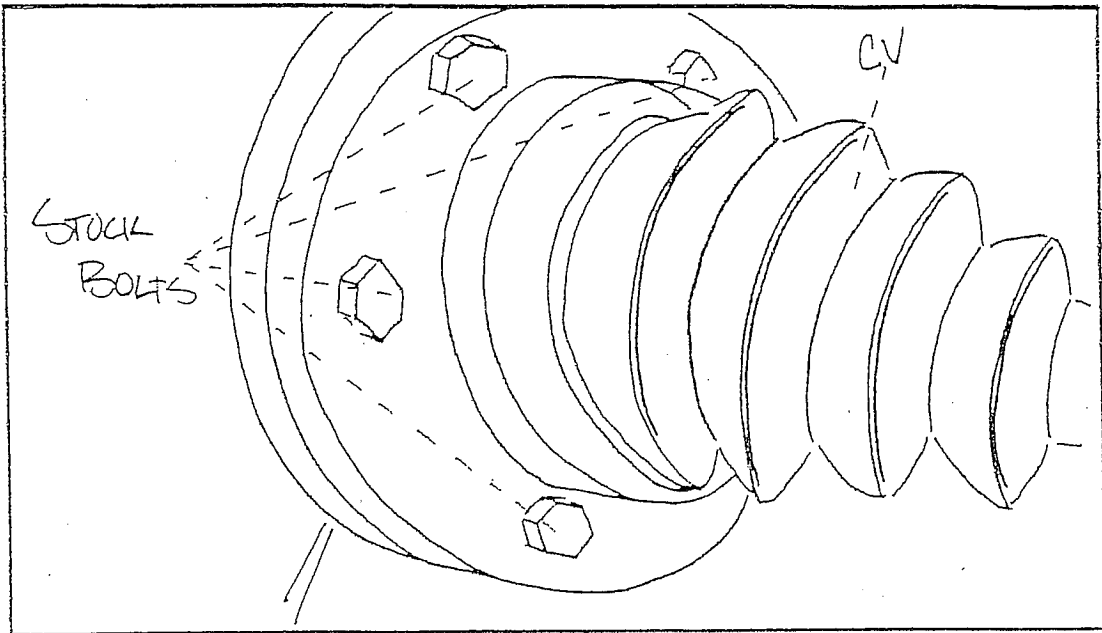

ILLUSTRATION # 5

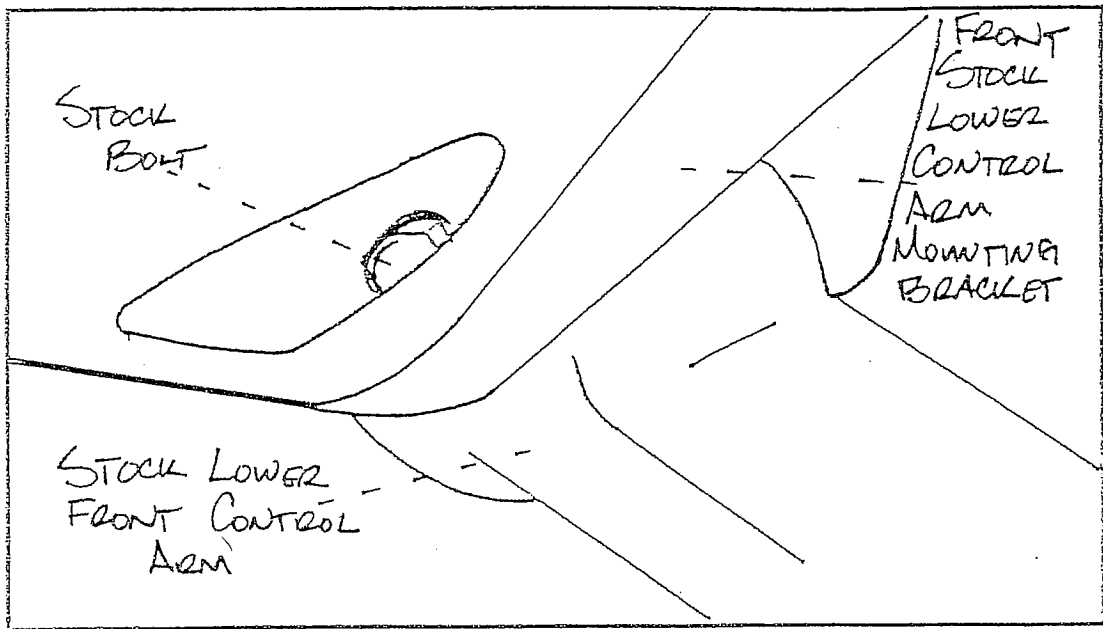

ILLUSTRATION # 6

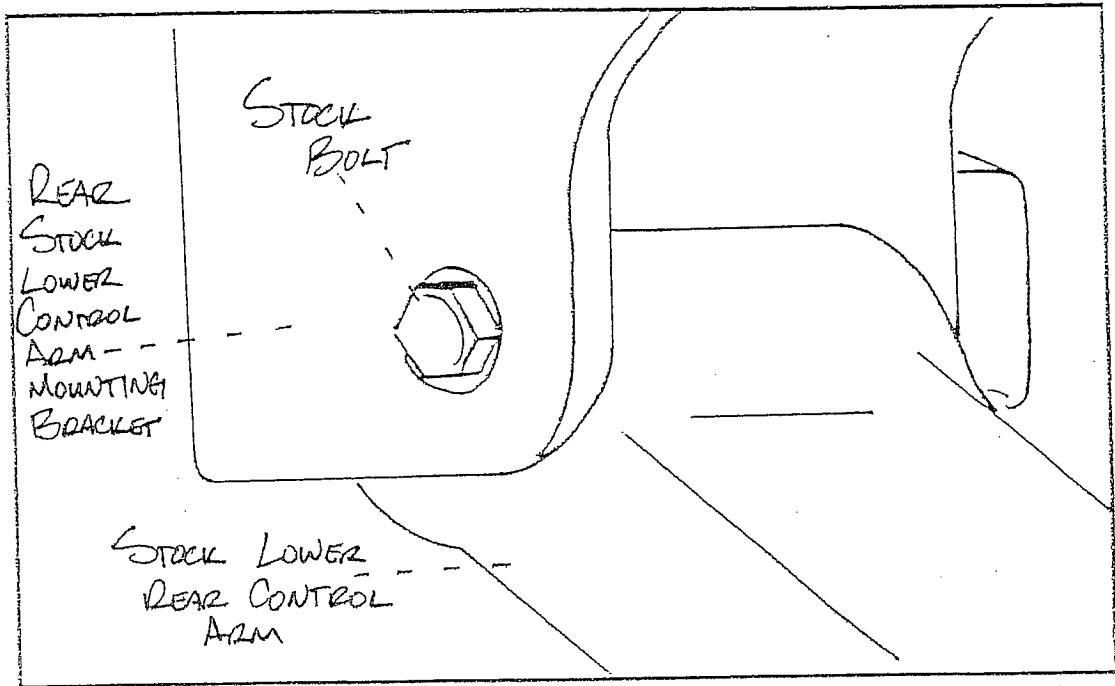

ILLUSTRATION # 7

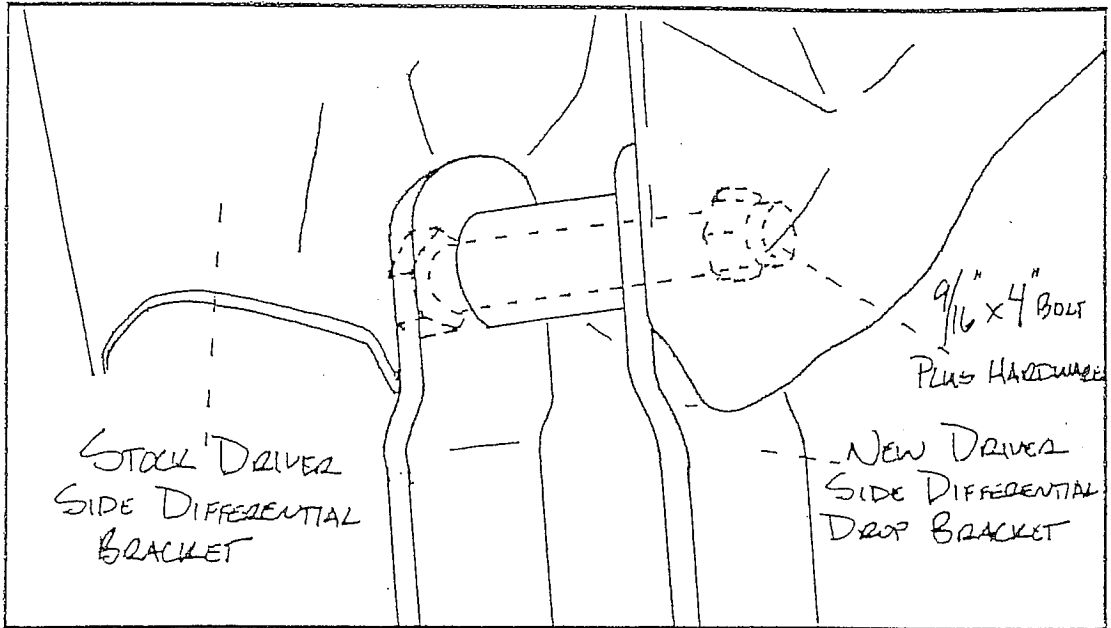

ILLUSTRATION # 8

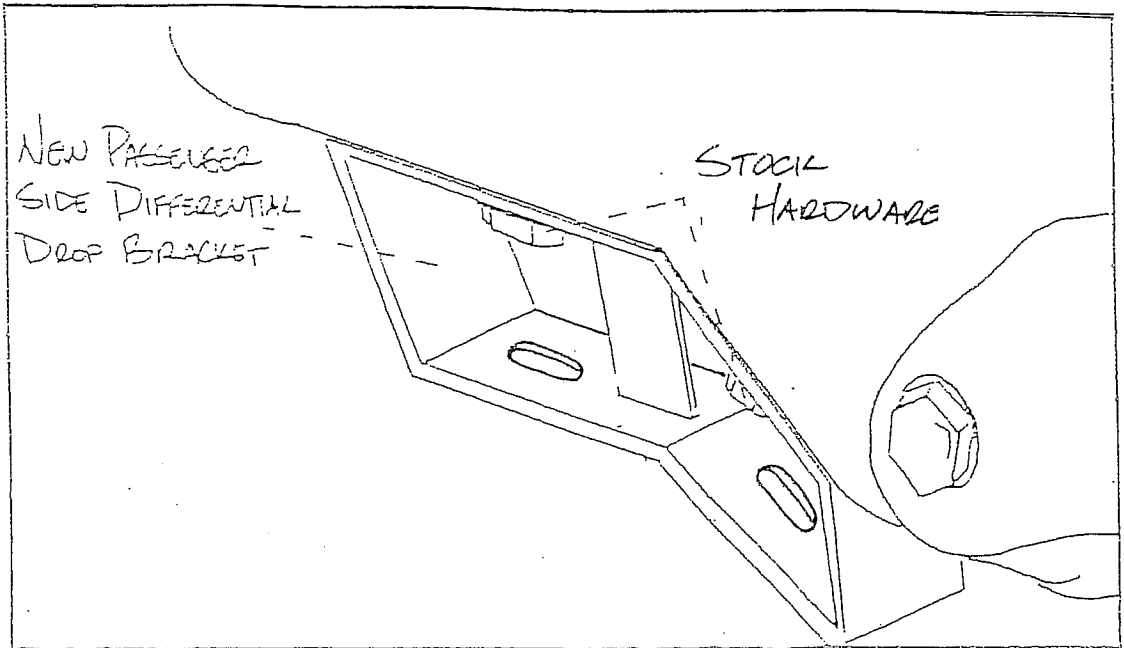

ILLUSTRATION # 9

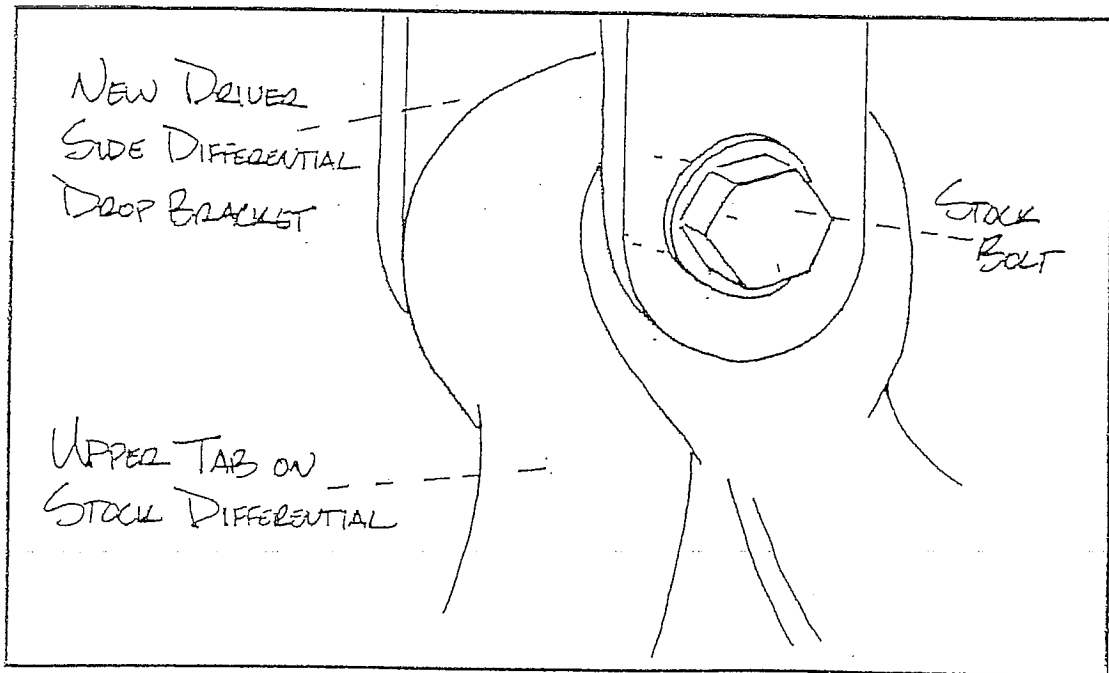

ILLUSTRATION # 10

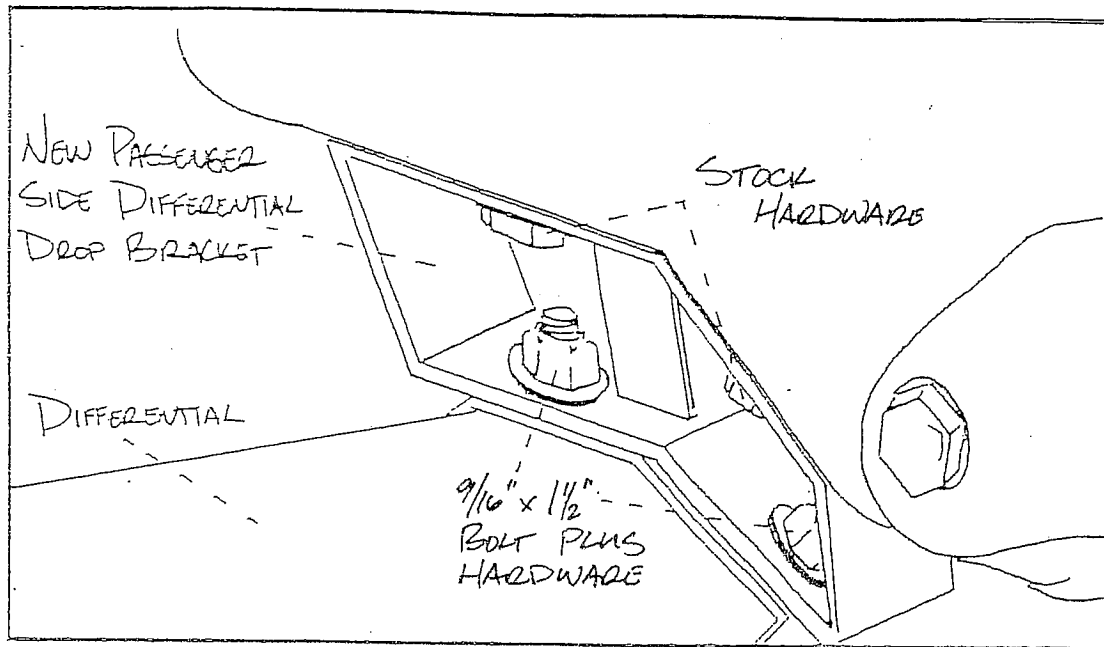
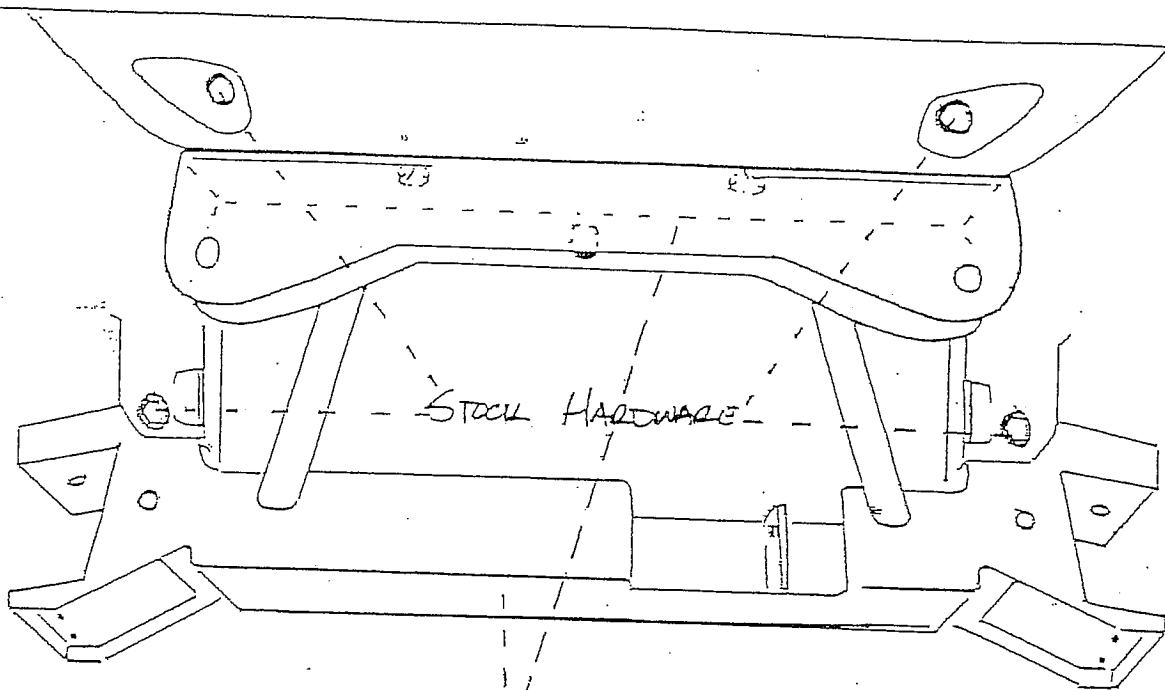

ILLUSTRATION # 11



NEW INTEGRATED
FRONT AND REAR
CROSS MEMBER

ILLUSTRATION # 12

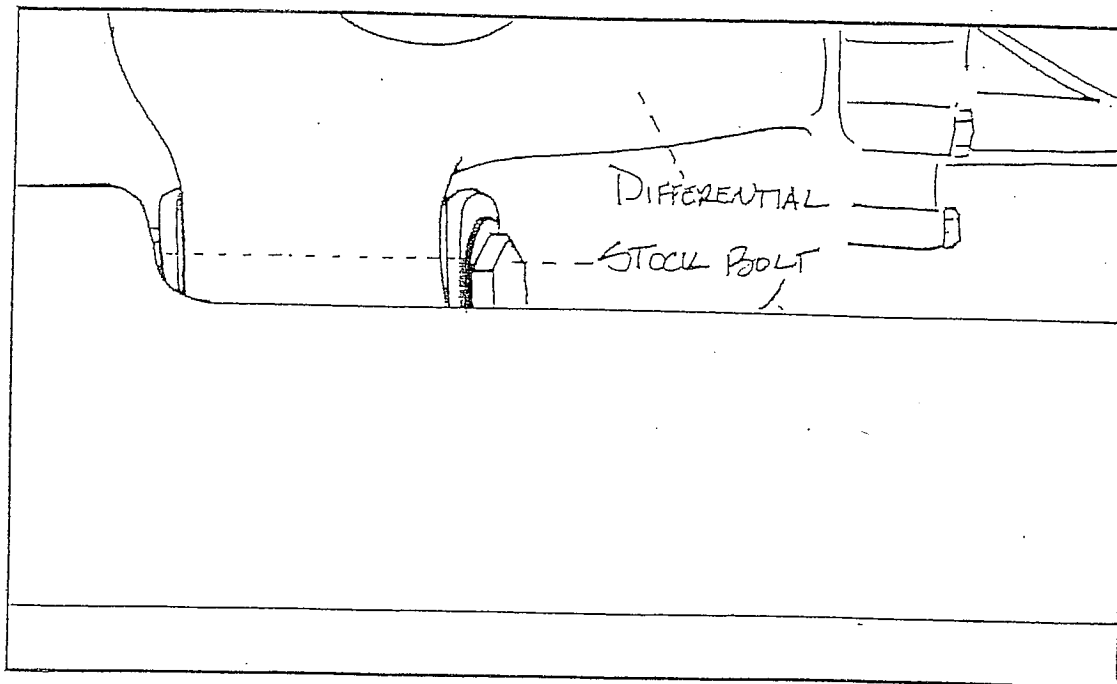

ILLUSTRATION # 13

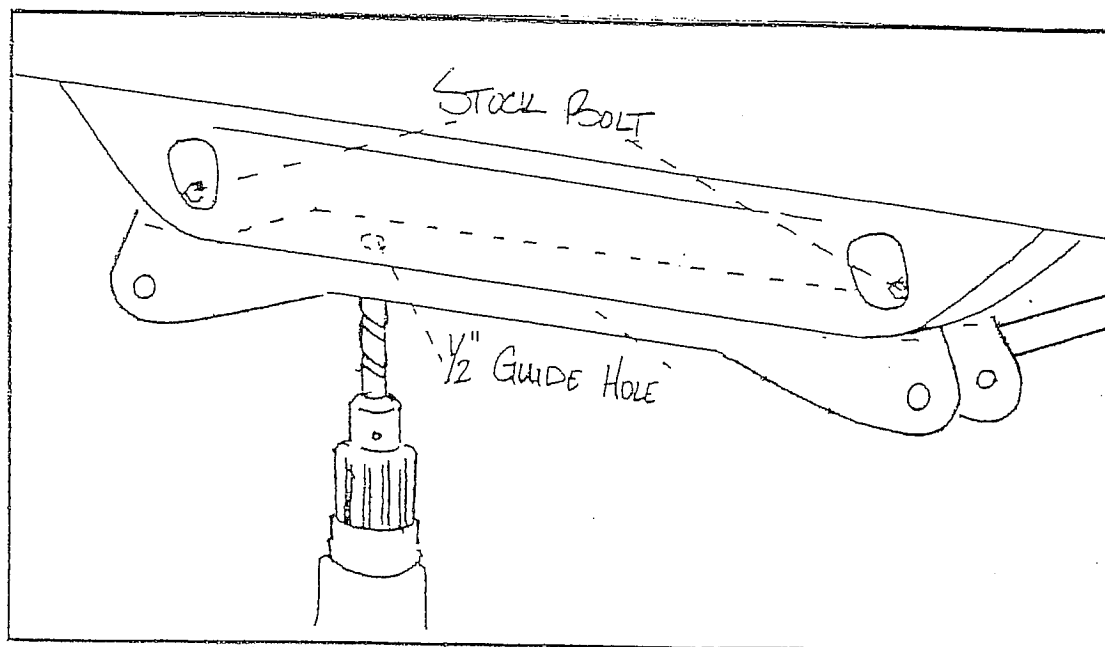

ILLUSTRATION # 14

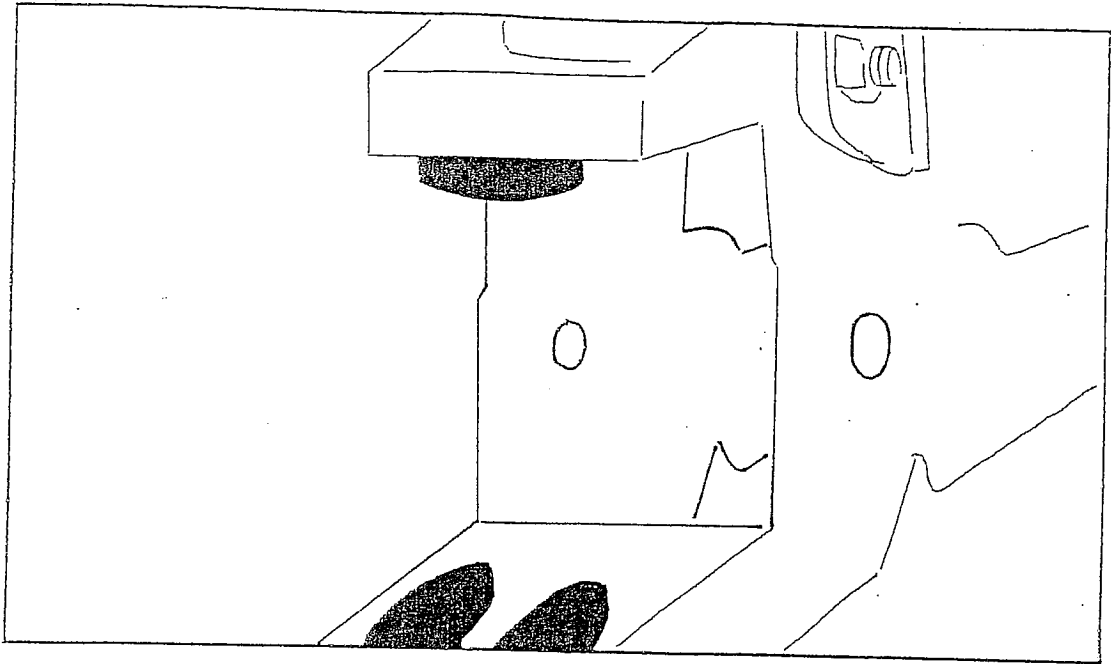

ILLUSTRATION # 15

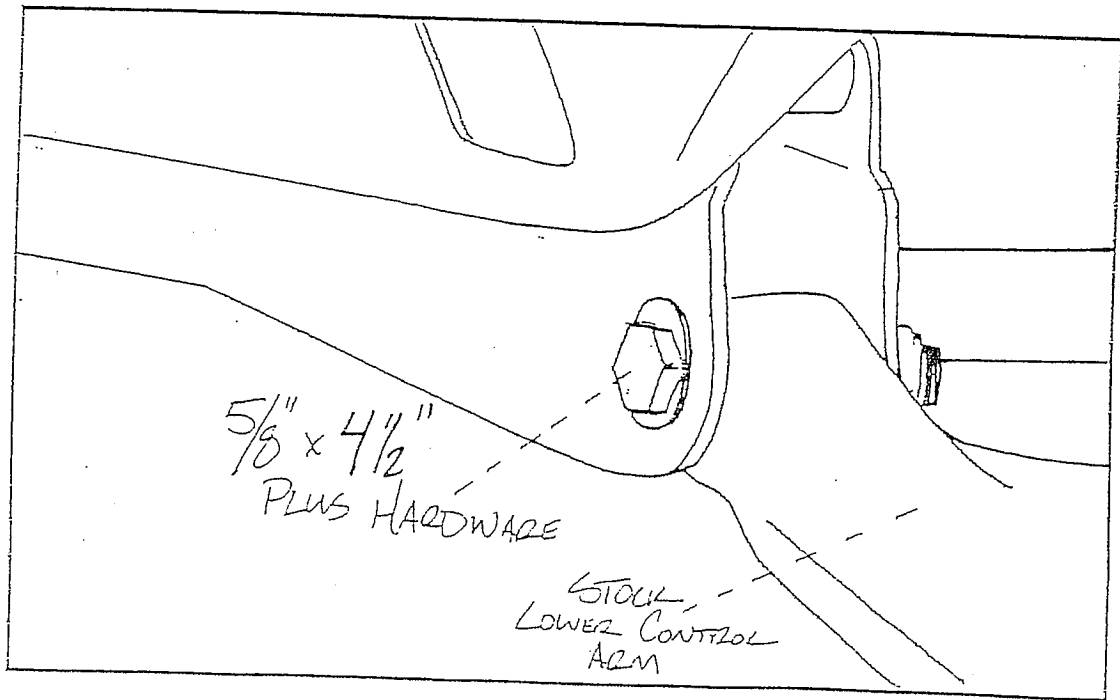

ILLUSTRATION # 16

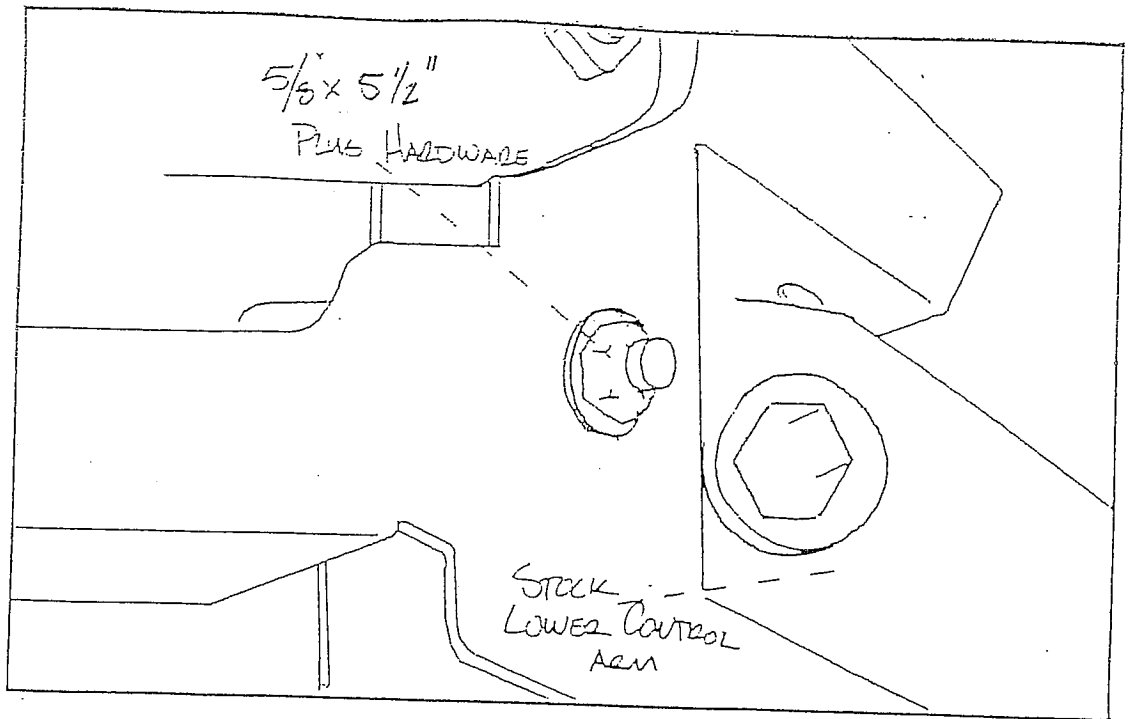

ILLUSTRATION # 17

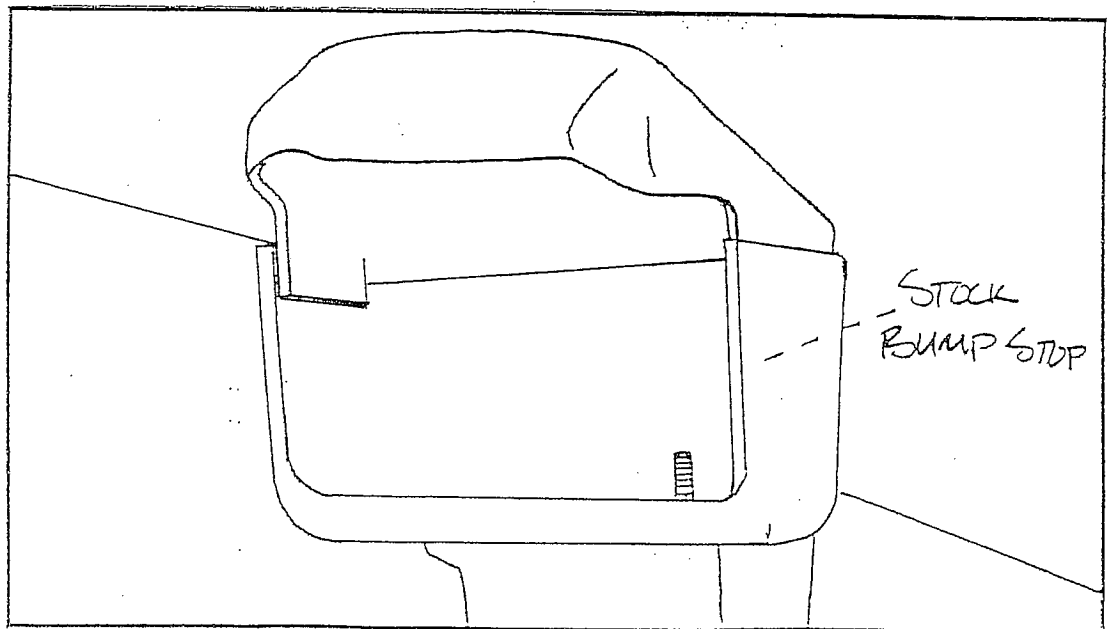

ILLUSTRATION # 18

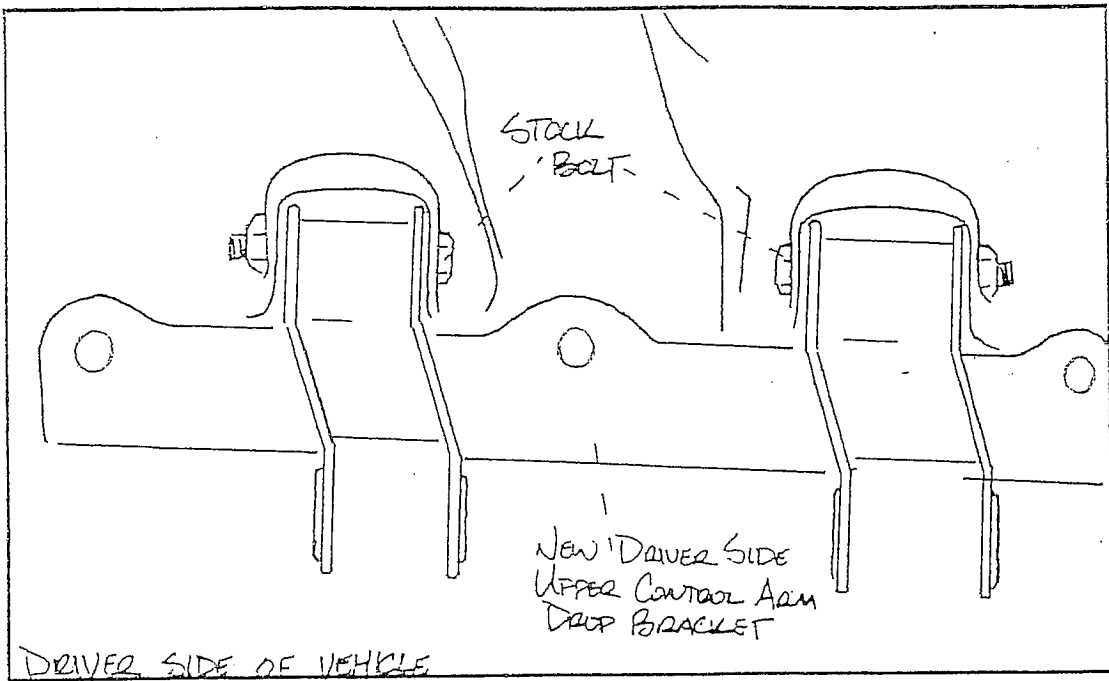

ILLUSTRATION # 19

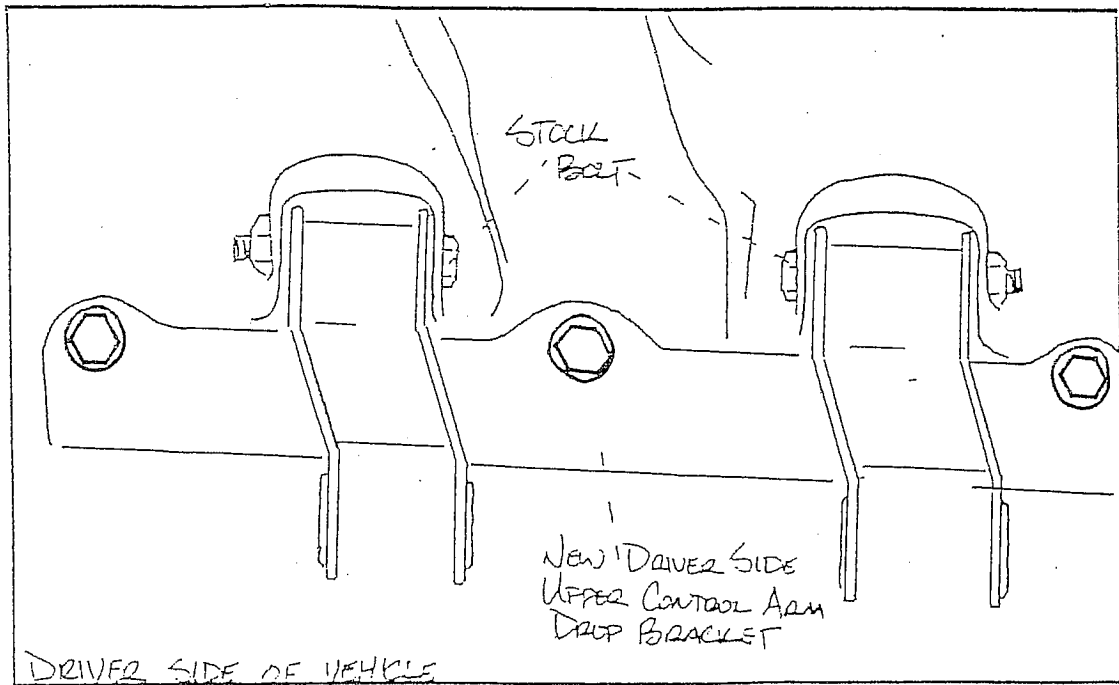

ILLUSTRATION # 20

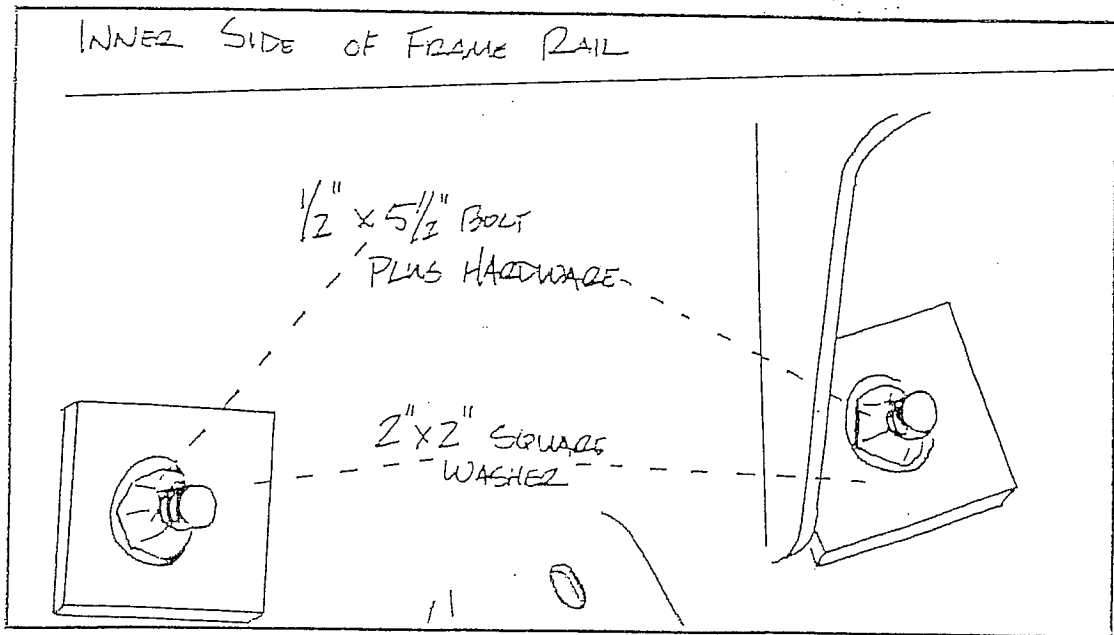

ILLUSTRATION # 21

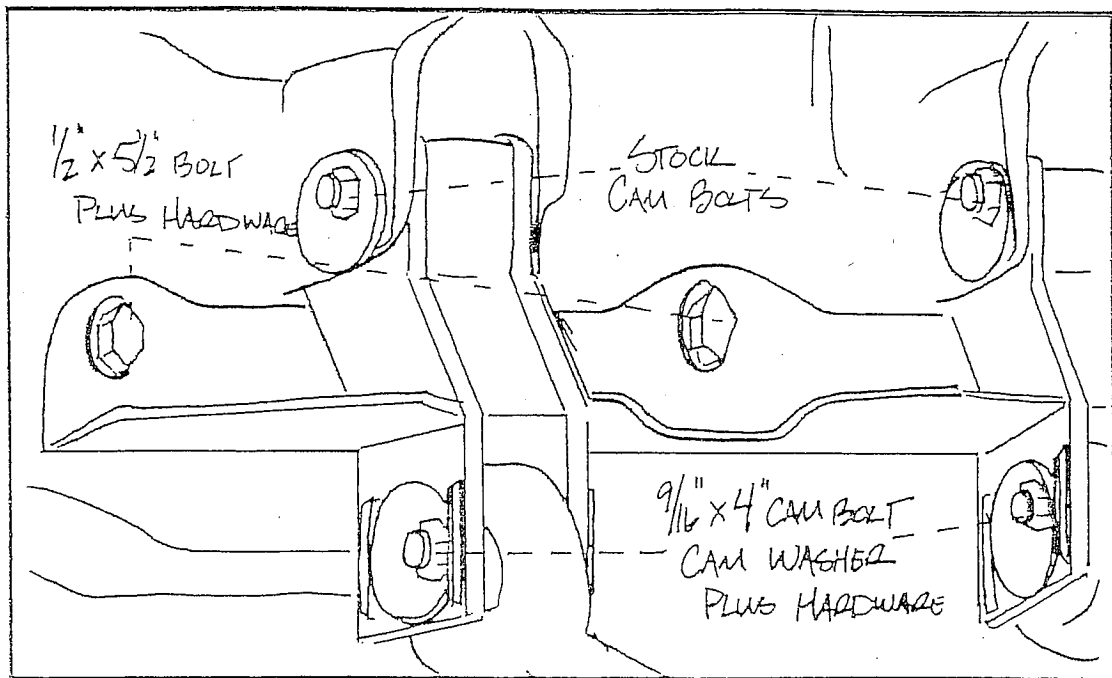

ILLUSTRATION # 22

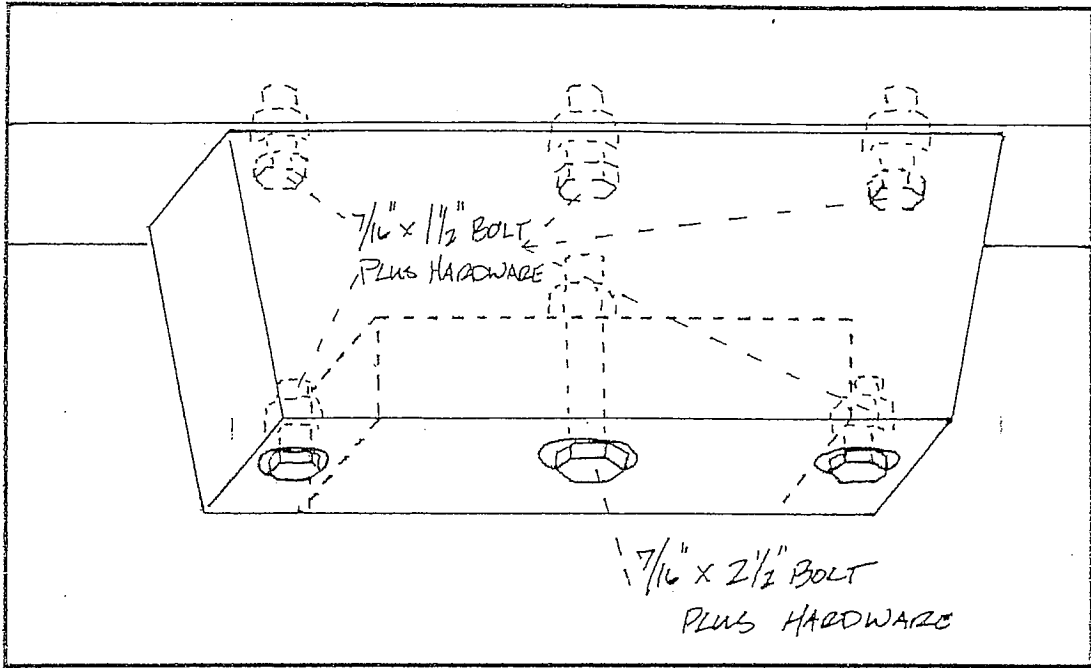

ILLUSTRATION # 23

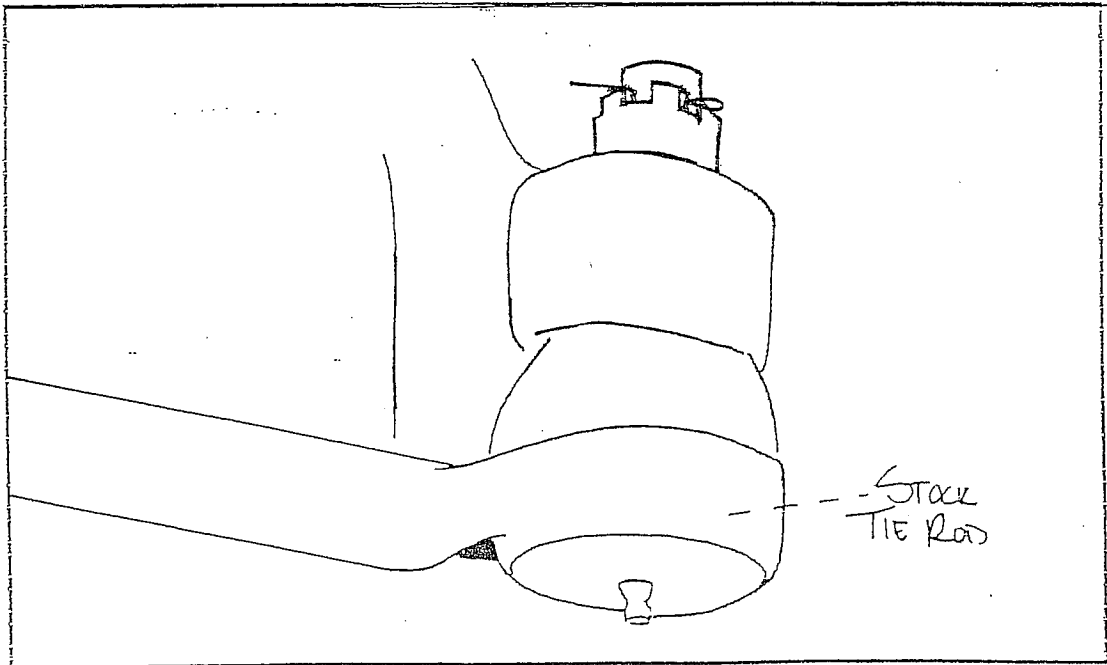

ILLUSTRATION # 24

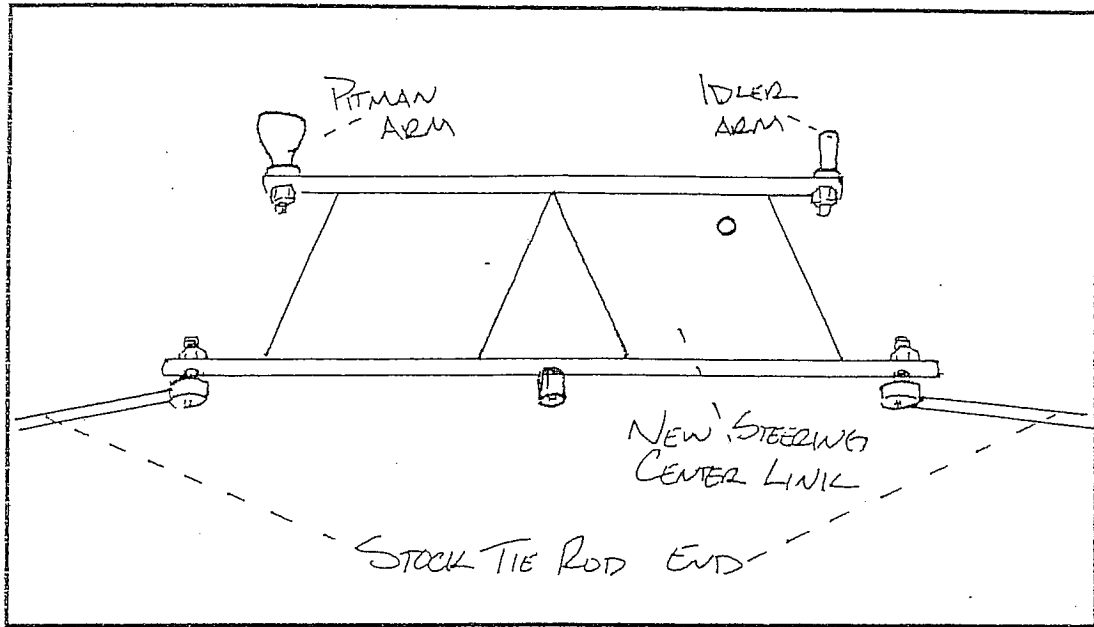

ILLUSTRATION # 25

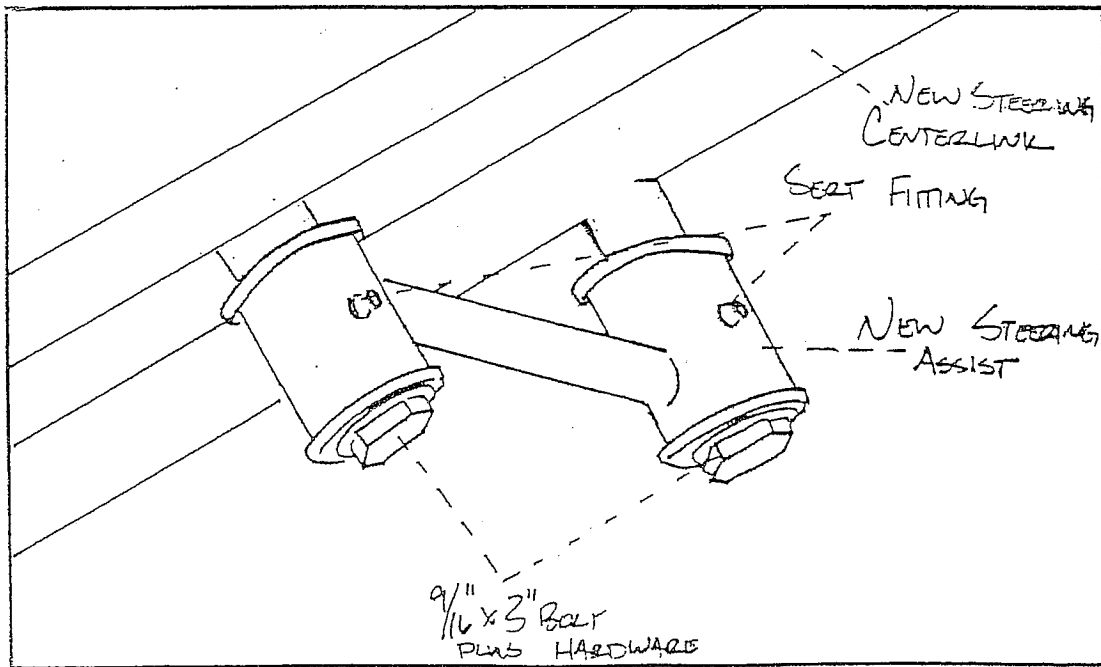

ILLUSTRATION # 26

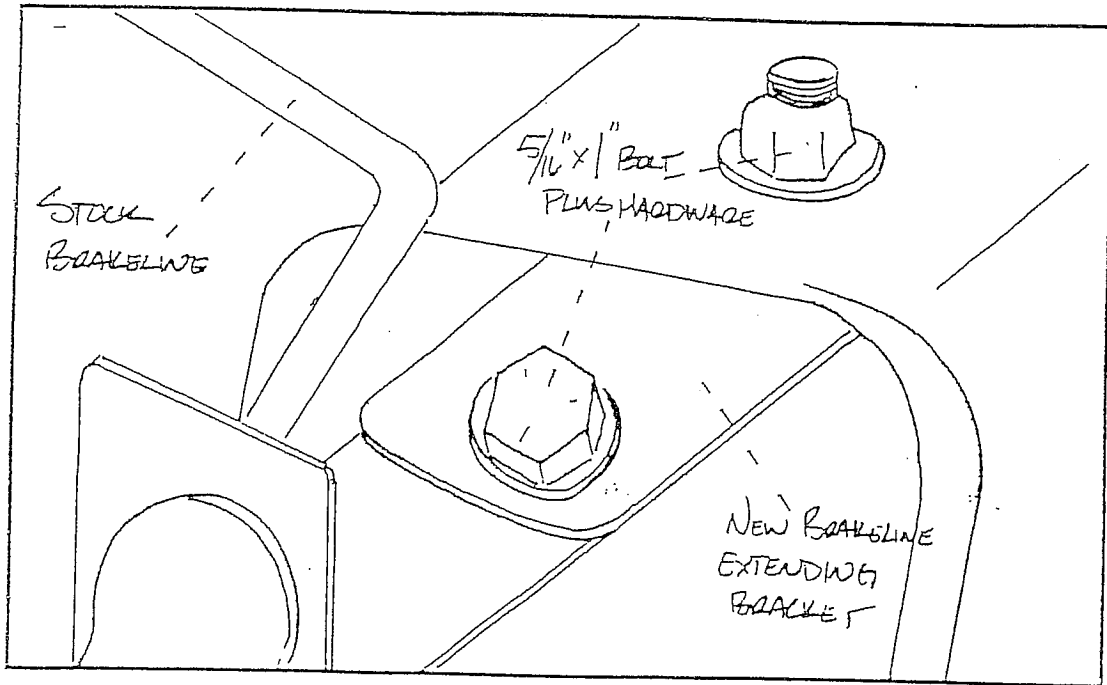

ILLUSTRATION # 27

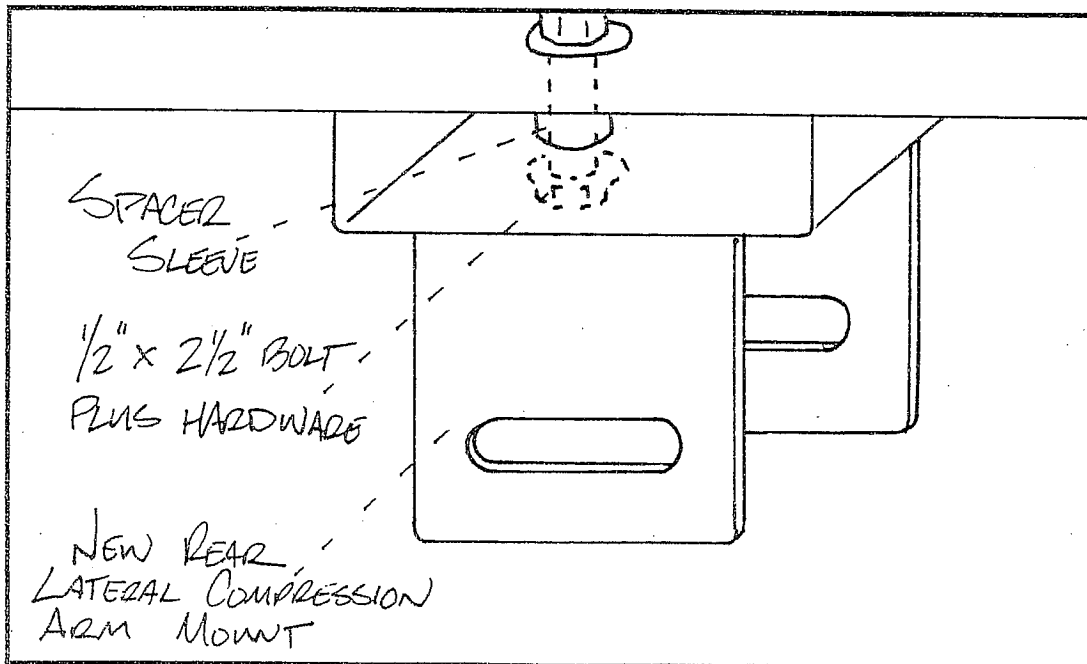

ILLUSTRATION # 28

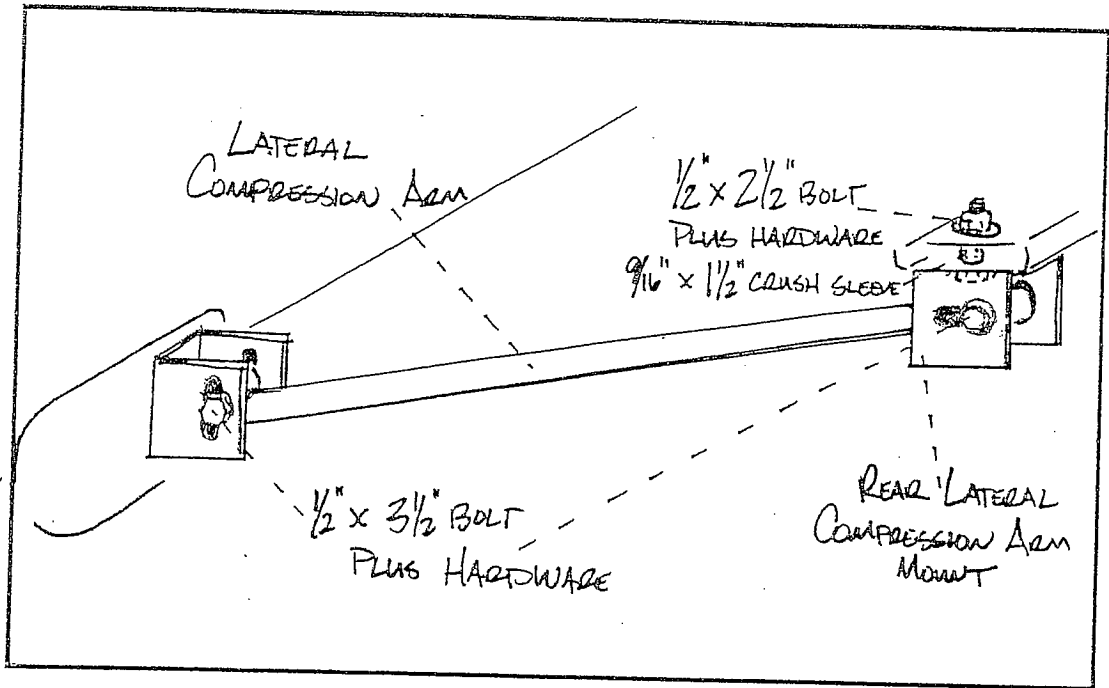

ILLUSTRATION # 29

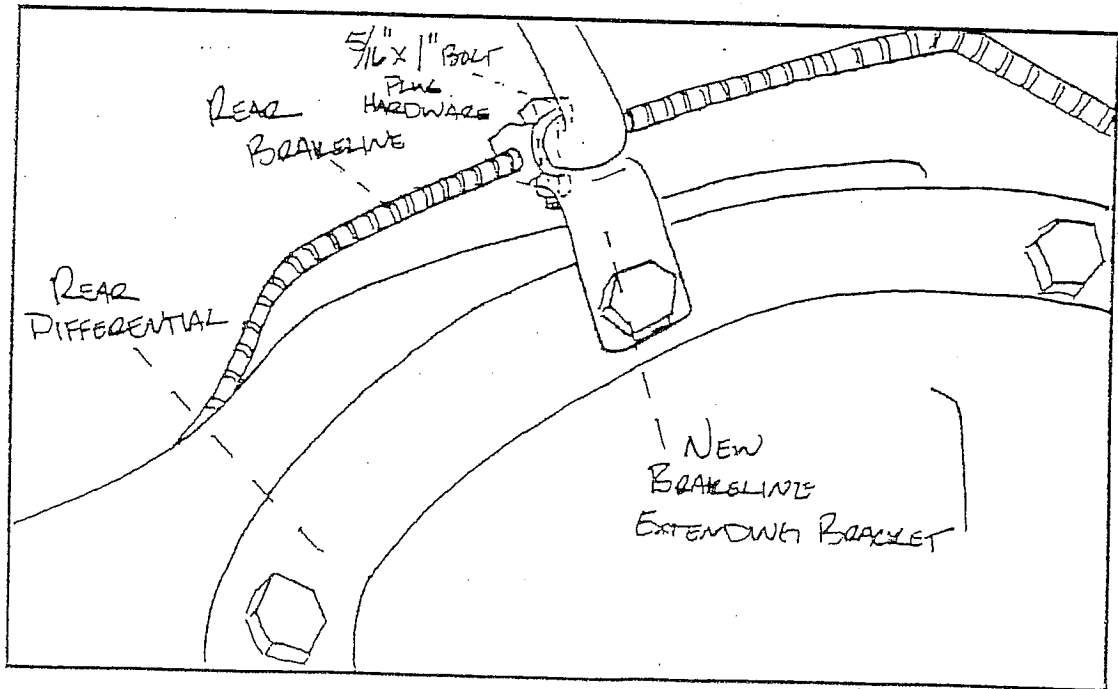

ILLUSTRATION # 30

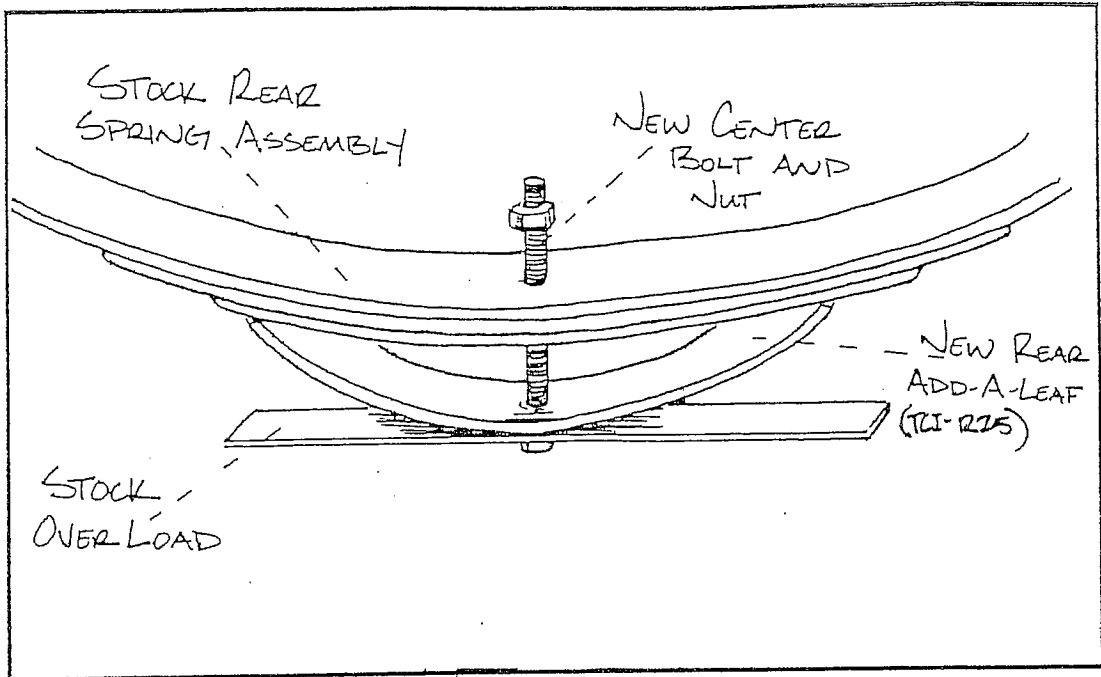

ILLUSTRATION # 31

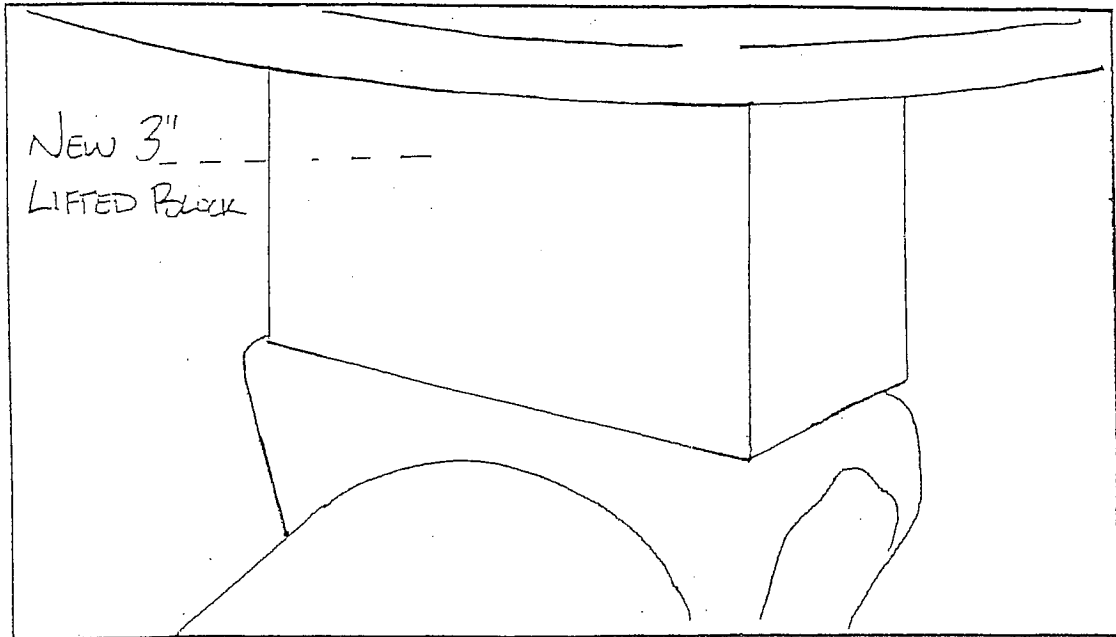

ILLUSTRATION # 32

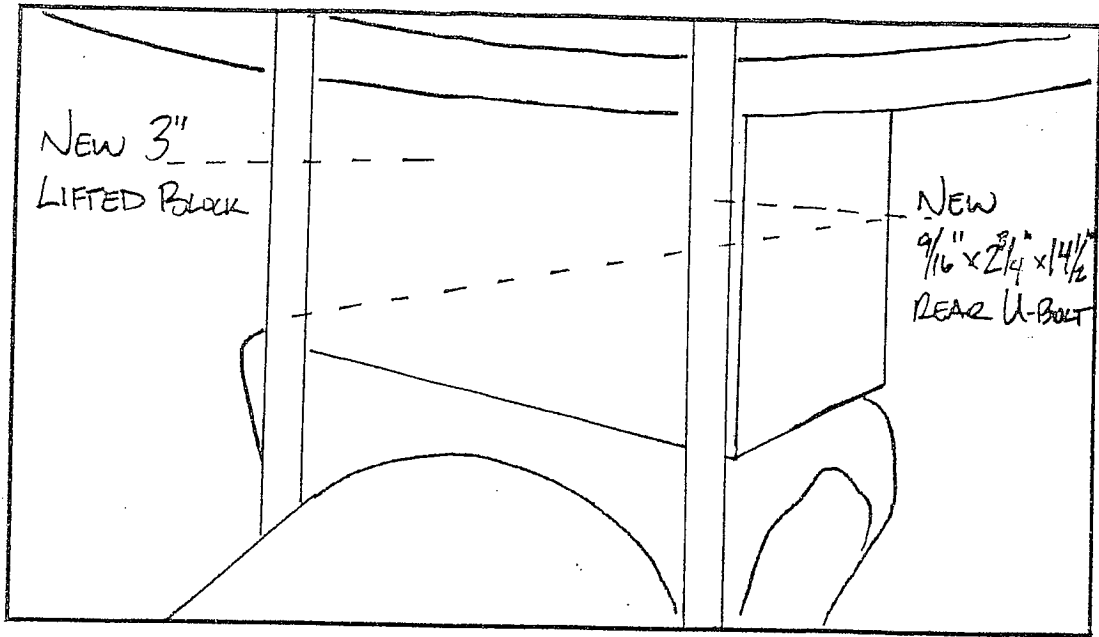

ILLUSTRATION # 33

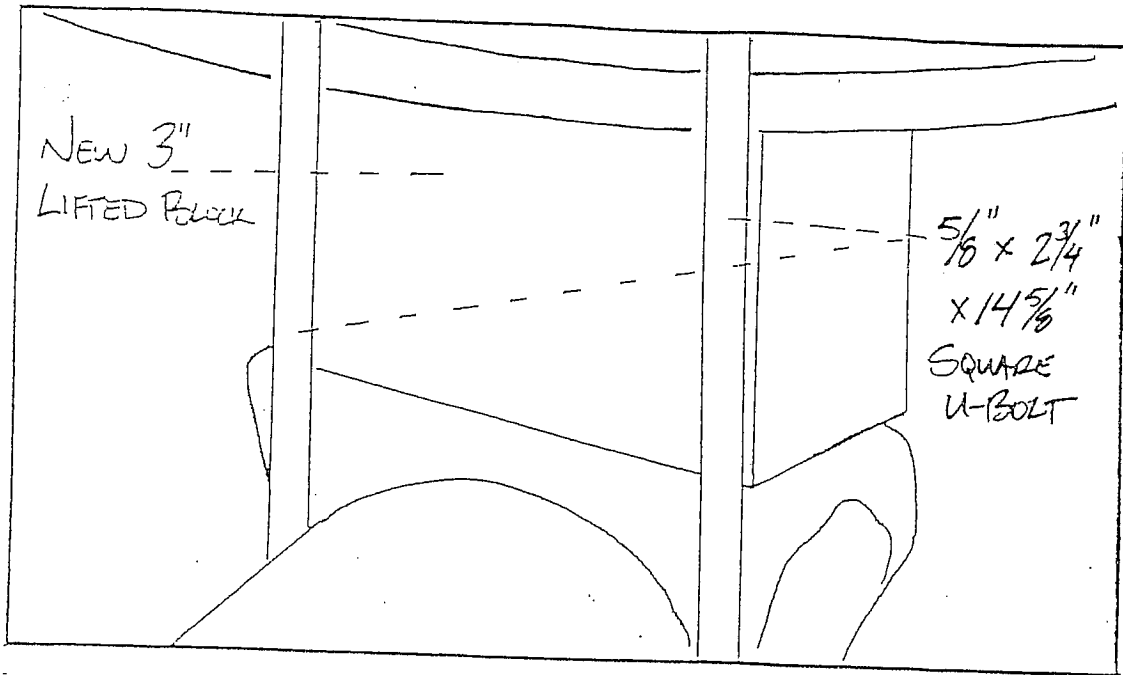

ILLUSTRATION # 34