



INSTALLATION INSTRUCTIONS

5" OVAL BENT END SIDEBARS
09-15 DODGE RAM 1500 QUAD CAB
PART NUMBER# 5-535553 5-530553

PARTS LIST:

Qty	Description	Qty	Description
1	Driver/Left Sidebar	6	12mm Lock Washers
1	Passenger/Right Sidebar	6	12mm Hex Nuts
2	Driver/Left Front and Center Mounting Brackets	6	10-1.5mm x 35mm Hex Bolts
1	Driver/Left Rear Mounting Bracket	6	10mm x 27mm OD x 3mm Flat Washers
2	Passenger/Right Front and Center Mounting Brackets	6	10mm Lock Washers
1	Passenger/Right Rear Mounting Brackets	12	8-1.25 x 25mm Hex Bolts
6	12mm Plastic Retainers	12	8mm x 24mm x 2mm Flat Washers
6	12mm x 35mm Bolt x 10mm Nut Plates	12	8mm Lock Washers
6	12mm x 32mm OD x 3mm Flat Washers		

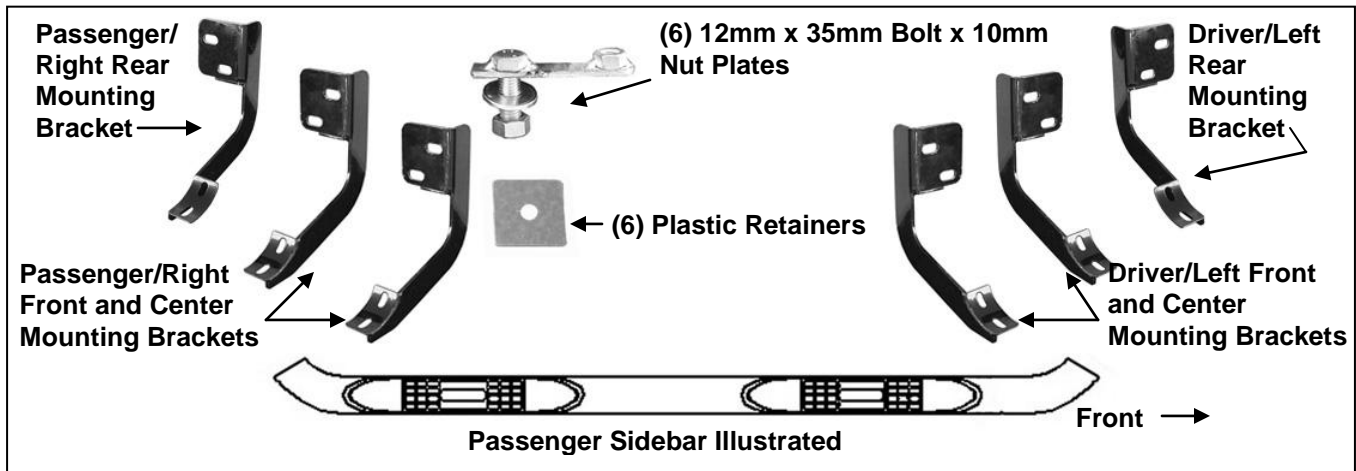

PROCEDURE:

- REMOVE CONTENTS FROM BOX. VERIFY ALL PARTS ARE PRESENT. READ INSTRUCTIONS CAREFULLY BEFORE STARTING INSTALLATION.**
- Starting at the driver side-front of the vehicle, remove the sealing tape covering the factory holes on the side of the inner panel, **(Figure 1A, 1B, 1C)**. Partially thread (1) 12mm Plastic Retainer onto the threaded end of (1) 12mm Bolt and Nut Plate, **(Figure 2A)**. Insert the Bolt and Nut Plate into the factory oval hole. Continue to thread the Plastic Retainer down the Bolt and Nut Plate until it is flush against the sheet metal, **(Figure 2B)**. **NOTE:** When properly installed, the Plastic Retainer is designed to prevent the Bolt and Nut Plate from falling into the body cavity during installation.
- Select the driver side front Mounting Bracket and partially hang it from the Bolt and Nut Plate with (1) 12mm Flat Washer, (1) 12mm Lock Washer and (1) 12mm Hex Nut. Do not tighten hardware at this time. Line up the remaining hole in the Mounting Bracket with the hole in the inner body panel. Rotate the Bolt and Nut Plate until the threaded end (Nut) lines up with the hole in the Mounting Bracket. Secure with (1) 10mm x 35mm Hex Bolt, (1) 10mm Lock Washer and (1) 10mm Flat Washer, **(Figures 3A, 3B, 3C)**. Snug but do not tighten hardware at this time.
- Repeat **Steps 2 - 3** for the center and rear Mounting Bracket installation. **NOTE:** The rear Mounting Brackets, **(Figure 3C)**, are slightly different from the front and center brackets, (see illustration above-note bolt pattern on mounting plate).
- Once all of the driver side Brackets have been installed, carefully position the driver Sidebar onto the (3) Mounting Brackets. Attach the Sidebar to the cradles on the Mounting Brackets with the included (6) 8mm x 25mm Hex Bolts, (6) 8mm Lock Washers, and (6) 8mm Flat Washers, **(Figure 4)**. Do not tighten hardware at this time. **IMPORTANT:** If you are having any difficulty with installation, check Mounting Bracket location first. Use the illustration on **Page 1** to identify the Mounting Brackets.
- Properly level and adjust the Sidebar and tighten all hardware at this time.
- Repeat **Steps 2 - 6** for passenger Sidebar installation.
- Do periodic inspections to the installation to make sure that all hardware is secure and tight.

To protect your investment, wax this product after installing. Regular waxing is recommended to add a protective layer over the finish. Do not use any type of polish or wax that may contain abrasives that could damage the finish.

For stainless steel: Aluminum polish may be used to polish small scratches and scuffs on the finish. Mild soap may be used also to clean the Sidebar.

For gloss black finishes: Mild soap may be used to clean the Sidebar.

Driver Side Installation Pictured

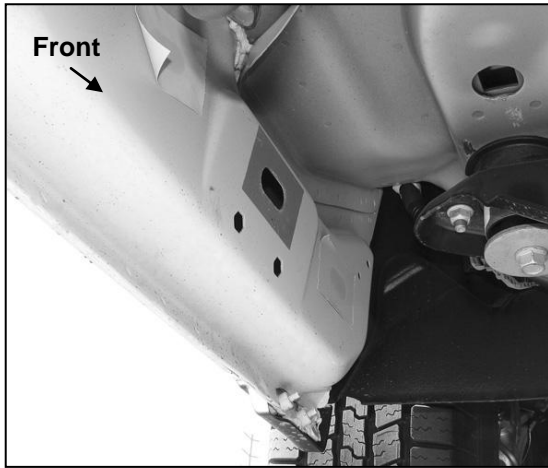

(Fig 1A) Driver/Left front mounting location

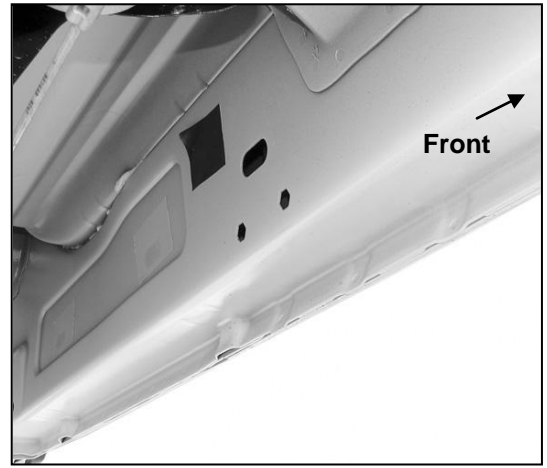

(Fig 1B) Driver/Left center mounting location

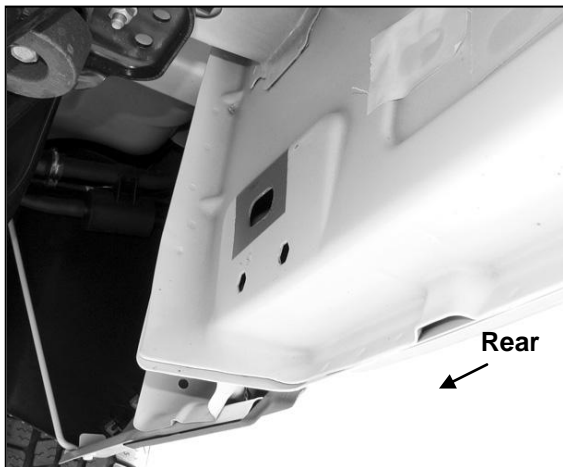

(Fig 1C) Driver/Left rear mounting location

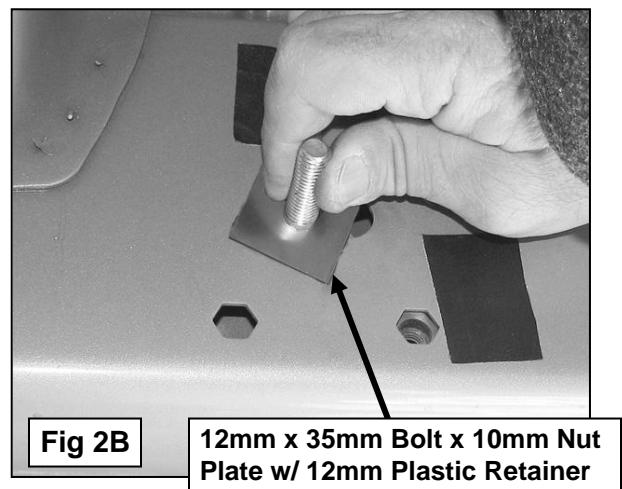
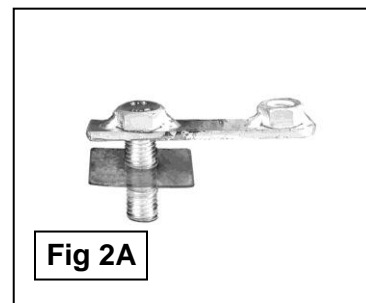

Driver Side Installation Pictured

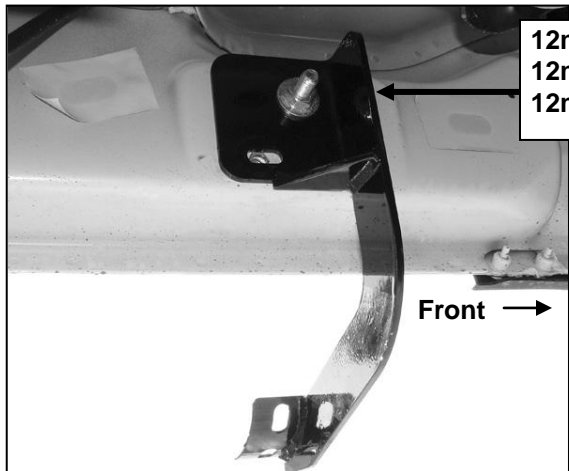

12mm Lock Washer
12mm Flat Washer
12mm Hex Nut

Front →

(Fig 3A) Driver/Left front Mounting Bracket

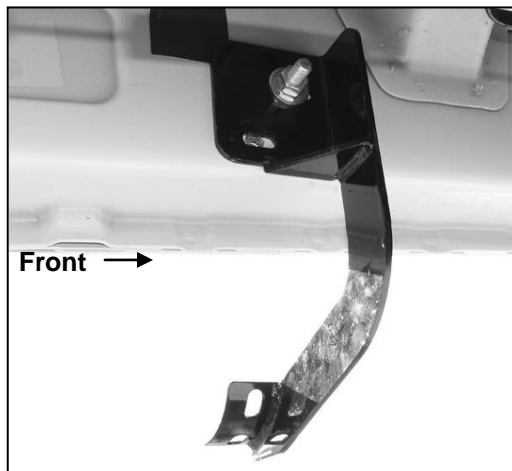

Front →

(Fig 3B) Driver/Left center Mounting Bracket

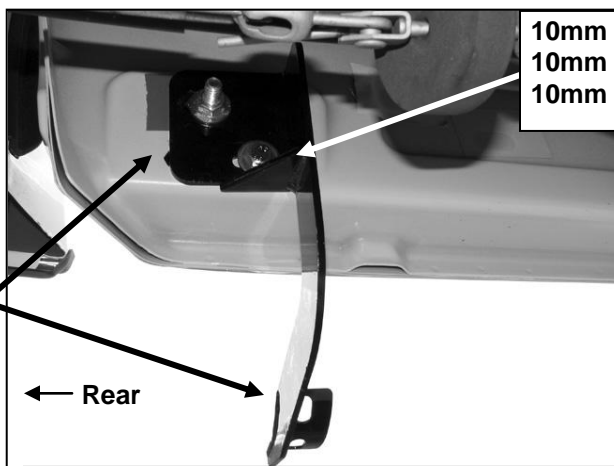

10mm x 30mm Hex Bolt
10mm Flat Washer
10mm Lock Washer

← Rear

(Fig 3C) Driver/Left rear Mounting Bracket

IMPORTANT: The rear Mounting Brackets look similar to the front and center brackets but they are unique. Note the reversed bolt pattern on the mounting plate and forward facing cradle for sidebar.



Fig 4

8mm x 25mm Hex Bolts
8mm Flat Washers
8mm Lock Washers



Installation Complete