



**INSTALLATION INSTRUCTIONS**

STRAIGHT SIDEBARS

09-13 DODGE RAM QUAD CAB

PART NUMBER 5-40453 5-45453

**PARTS LIST:**

Qty	Description	Qty	Description
1	Driver/Left Sidebar	4	12mm Lock Washers
1	Passenger/Right Sidebar	4	12mm Hex Nuts
1	Driver/Left Front Mounting Bracket	4	10-1.5mm x 35mm Hex Bolts
1	Passenger/Right Front Mounting Bracket	4	10mm x 27mm OD x 3mm Flat Washers
1	Driver/Left Rear Mounting Bracket	4	10mm Lock Washers
1	Passenger/Right Rear Mounting Bracket	8	8-1.25 x 25mm Hex Bolts
4	12mm Plastic Retainers	8	8mm x 24mm x 2mm Flat Washers
4	12mm x 35mm Bolt x 10mm Nut Plates	8	8mm Lock Washers
4	12mm x 32mm OD x 3mm Flat Washers		

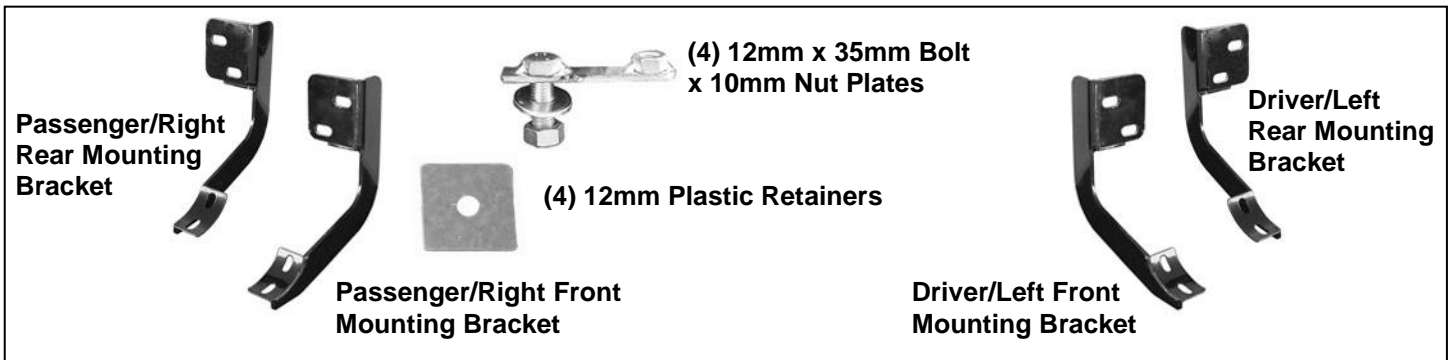

**PROCEDURE:**

- 1. REMOVE CONTENTS FROM BOX. VERIFY ALL PARTS ARE PRESENT. READ INSTRUCTIONS CAREFULLY BEFORE STARTING INSTALLATION.**
- Starting at the driver side-front of the vehicle, remove the sealing tape covering the factory holes on the side of the inner panel, **(Figure 1A & 1B)**. Partially thread (1) 12mm Plastic Retainer onto the threaded end of (1) 12mm Bolt and Nut Plate. Insert the Bolt and Nut Plate into the factory oval hole. Continue to thread the Plastic Retainer down the Bolt and Nut Plate until it is flush against the sheet metal, **(Figure 2)**. **NOTE:** When properly installed, the Plastic Retainer is designed to prevent the Bolt and Nut Plate from falling into the body cavity during installation.
- Select the driver side front Mounting Bracket and partially hang it from the Bolt and Nut Plate with (1) 12mm Flat Washer, (1) 12mm Lock Washer and (1) 12mm Hex Nut. Do not tighten hardware at this time. Line up the remaining hole in the Mounting Bracket with the hole in the inner body panel. Rotate the Bolt and Nut Plate until the threaded end (Nut) lines up with the hole in the Mounting Bracket. Secure with (1) 10mm x 35mm Hex Bolt, (1) 10mm Lock Washer and (1) 10mm Flat Washer, **(Figure 3A & 3B)**. Snug but do not tighten hardware at this time.
- Repeat the installation procedure in Steps 2-3 for all remaining Mounting Brackets. Use the illustration on Page 1 to determine the correct Mounting Bracket for each of the remaining locations.
- Once all of the brackets have been installed, with assistance, carefully position the driver Sidebar onto the Mounting Brackets. Partially attach the Sidebar to the cradles on the Mounting Brackets using the included (6) 8mm x 25mm Hex Head Bolts, (6) 8mm Lock Washers, and (6) 8mm Flat Washers, **(Figure 4)**. Do not tighten hardware at this time.
- Properly level and adjust the Sidebar, then tighten all hardware at this time. Repeat steps 2-6 for passenger Side Bar installation.
- Do periodic inspections to the installation to make sure that all hardware is secure and tight.

**To protect your investment**, wax this product after installing. Regular waxing is recommended to add a protective layer over the finish. Do not use any type of polish or wax that may contain abrasives that could damage the finish.

**For stainless steel:** Aluminum polish may be used to polish small scratches and scuffs on the finish. Mild soap may be used also to clean the Sidebar.

**For gloss black finishes:** Mild soap may be used to clean the Sidebar.

***Driver Side Installation Pictured***

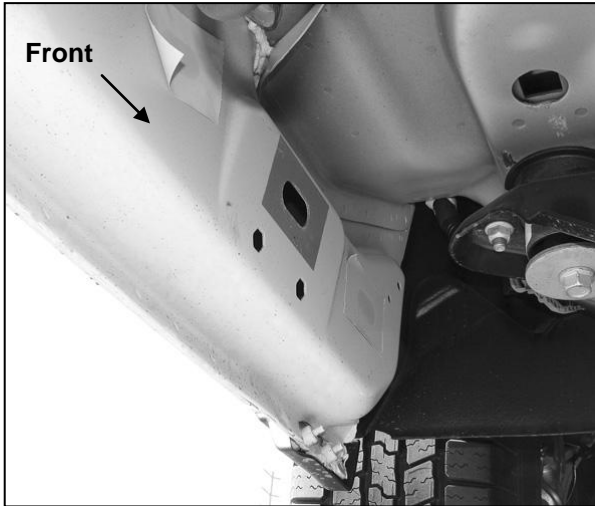

**(Fig 1A) Driver/Left front mounting location**

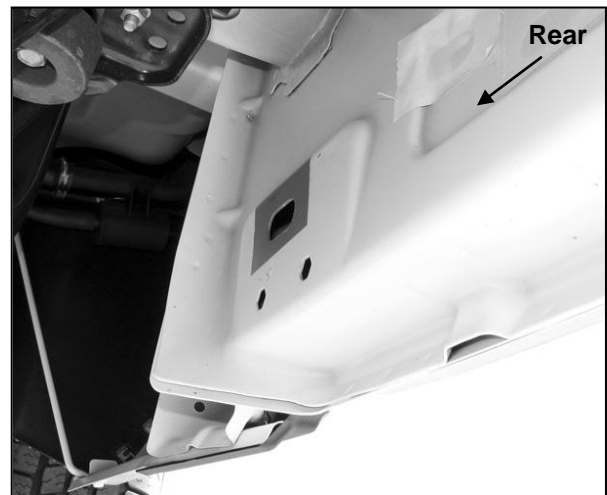

**(Fig 1B) Driver/Left rear mounting location**

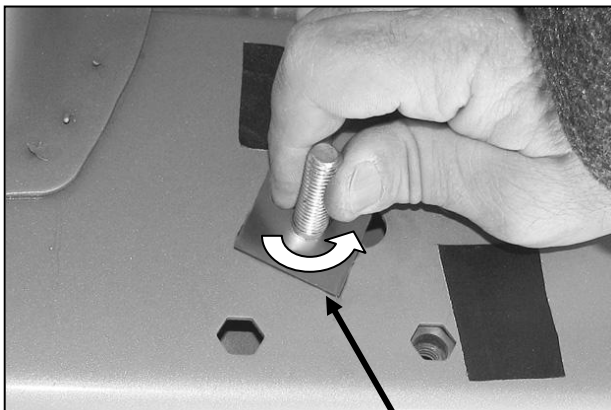

**Fig 2**

**12mm x 35mm Bolt x 10mm Nut Plate w/ 12mm Plastic Retainer. Rotate Bolt Plate to align threaded hole with hole in Mounting Bracket**

**Driver Side Installation Pictured**

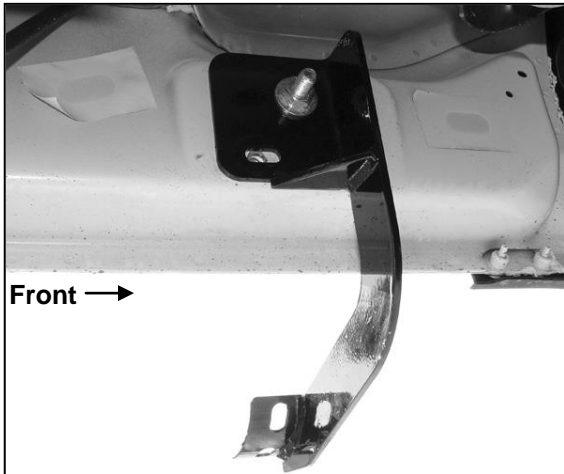

**(Fig 3A) Driver/Left front Mounting Bracket**

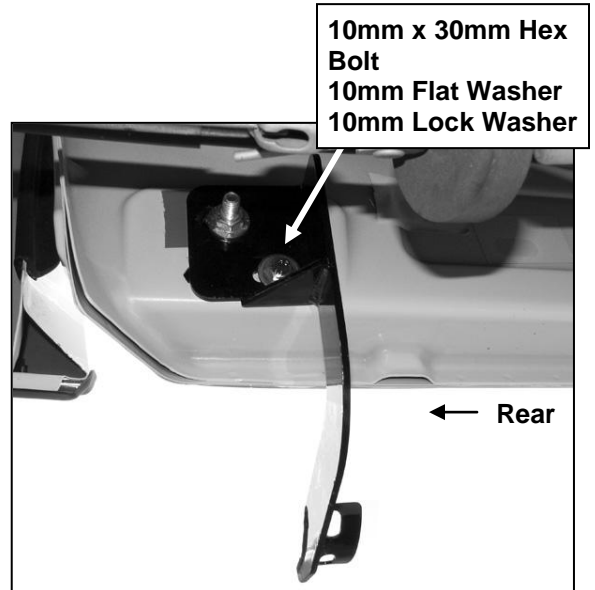

**(Fig 3B) Driver/Left rear Mounting Bracket**

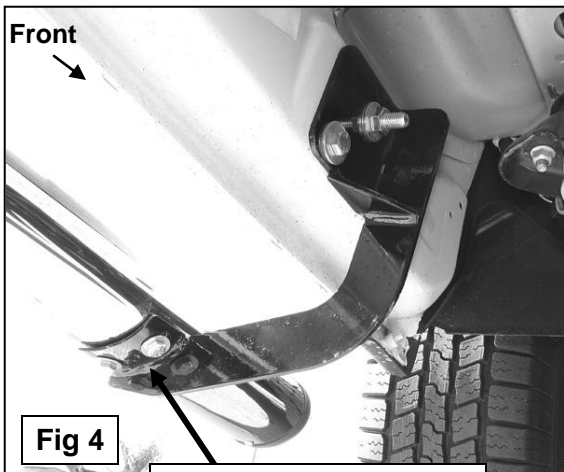

**Fig 4**

**8mm x 25mm Hex Bolts  
8mm Flat Washers  
8mm Lock Washers**



**Installation Complete**