



INSTALLATION INSTRUCTIONS

3" SIDEBAR WITH BENT END
04-12 CHEVY COLORADO/ GMC CANYON CREW CAB PART
NUMBER 1-0513 1-5513

PARTS LIST:

1	Driver/Left Sidebar	4	1/2 x 2" Hex Head Bolts
1	Passenger/Right Sidebar	4	1/2 Lock Washers
1	Driver/Left Front Mounting Bracket	4	1/2 x 1-1/2 x 1/8 Flat Washers
1	Passenger/Right Front Mounting Bracket	4	14mm x 50mm OD x 4mm Flat Washers
1	Driver/Left Rear Mounting Bracket	2	12mm Nut Plates
1	Passenger/Right Rear Mounting Bracket	2	12-1.75mm x 120mm Hex Bolts
1	Driver/Left Front Support Bracket	2	12mm x 30mm Hex Head Bolts
1	Passenger/Right Front Support Bracket	6	12mm x 32mm OD x 3mm Flat Washers
1	Driver/Left Rear Support Bracket	4	12mm Lock Washers
1	Passenger/Right Rear Support Bracket	2	12mm Hex Nuts

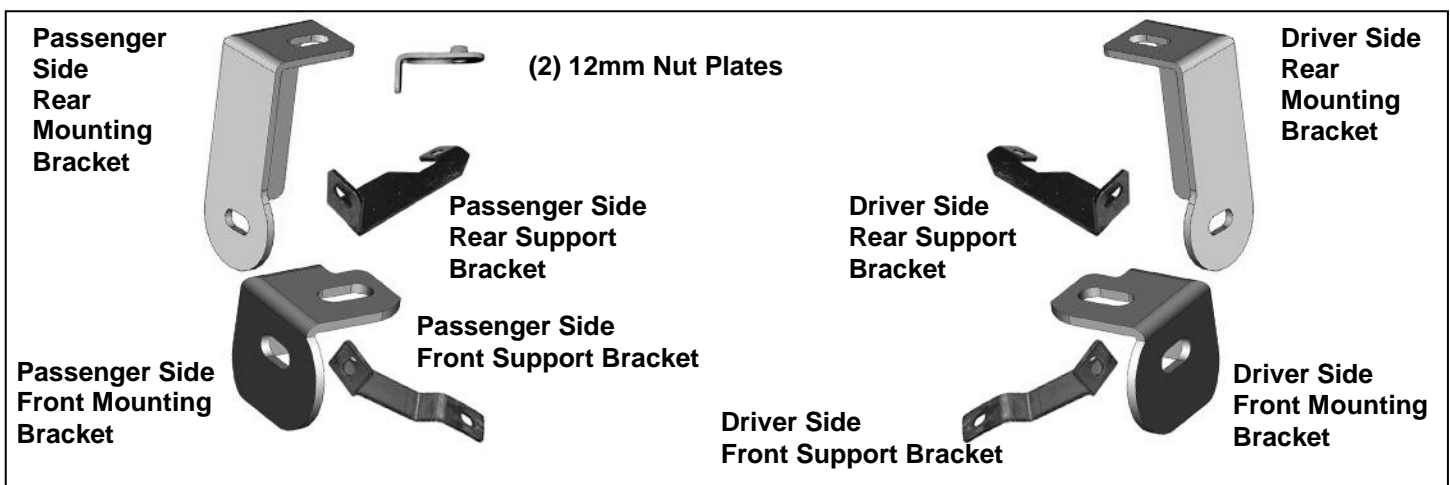

PROCEDURE:

- 1. REMOVE CONTENTS FROM BOX. VERIFY ALL PARTS ARE PRESENT. READ INSTRUCTIONS CAREFULLY BEFORE STARTING INSTALLATION.**
- Starting on the driver side, remove the factory front body mount bolt from the underside of the cab, **(Figure 1)**. **NOTE:** The factory body mount bolts need to be driven out of and back into the steel washer molded into the rubber bushing. Take precautions to avoid damage to the threads on the bolt or the washer and bushing, **(Figure 2)**.
- Locate the driver side front Mounting Bracket and bolt it to the vehicle using the factory body mount bolt, **(Figure 3)**. **NOTE:** Brackets mount over bushings. Do not tighten at this time.
- Select the driver side Front Support Bracket and insert (1) 12mm x 120mm Hex Bolt with (1) 12mm Flat Washer through the mounting slot. Place (2) 14mm x 50mm OD x 4mm Flat Washers onto the 12mm Hex Bolt between the Support Bracket and the factory body mount, **(Figure 4)**. Insert the 12mm Hex Bolt up through the holes in the factory body mount and secure with (1) 12mm Flat Washer, (1) 12mm Lock Washer and (1) 12mm Hex Nut, **(Figure 5A & 5B)**. Snug but do not tighten hardware at this time.
- Locate the driver side rear Mounting Bracket and bolt it to the vehicle using the factory body mount bolts, **(Figure 6A & 6B)**. **NOTE:** Brackets mount over bushings. Refer to Step 2 for installation instructions. **IMPORTANT:** Position the Mounting Bracket so that there is a minimum 1/4" gap between the rear Mounting Bracket and the inner body panel, **(Figure 6B)**. Do not allow the Mounting Bracket to come in contact with the body panel.

6. Insert one of the 12mm Nut Plates through the bottom of the front face of the leaf spring mounting bracket and align it to the factory oval hole, **(Figure 6A & 7)**.
7. With the 90-degree bend towards the side of the vehicle and facing up, partially attach the driver side Support Bracket to the already inserted Nut Plate using the included (1) 12mm x 30mm Hex Head Bolt, (1) 12mm Lock Washer and (1) 12mm Flat Washer, **(Figure 8)**. **NOTE:** When properly installed, the bent end of the Support Bracket should line up with the hole in the Mounting Bracket. Snug but do not tighten hardware at this time.
8. Carefully position the driver Sidebar up to the Mounting Brackets. Line up the mounting hole in the Front Support Bracket with the hole in the Front Mounting Bracket, **(Figure 9)**. Use the included (2) 1/2" x 2" Hex Head Bolts, (2) 1/2" Lock Washers, and (2) 1/2" Flat Washers to attach the Sidebar to the Mounting Brackets, **(Figure 10 & 11)**.
9. Adjust the Sidebar properly and then tighten all hardware.
10. Repeat steps 2 – 9 for passenger Sidebar installation.
11. Do periodic inspections of the installation to make sure that all hardware is secure and tight.

To protect your investment, wax this product after installing. Regular waxing is recommended to add a protective layer over the finish. Do not use any type of polish or wax that may contain abrasives that could damage the finish.

For stainless steel: Aluminum polish may be used to polish small scratches and scuffs on the finish. Mild soap may be used also to clean the Sidebar.

For gloss black finishes: Mild soap may be used to clean the Sidebar

Driver Side Installation Pictured

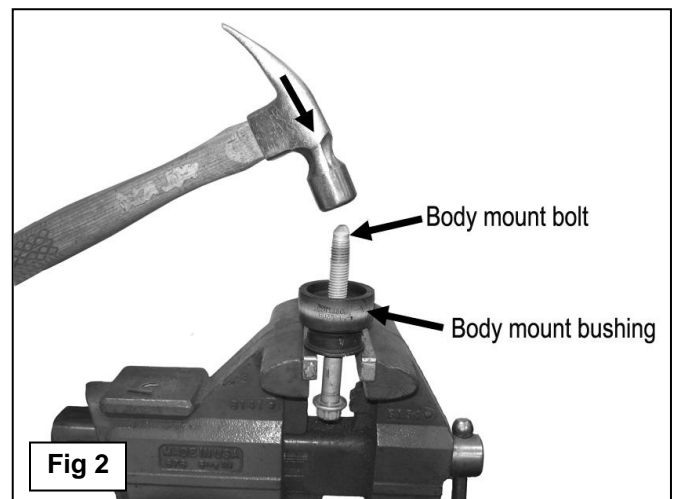
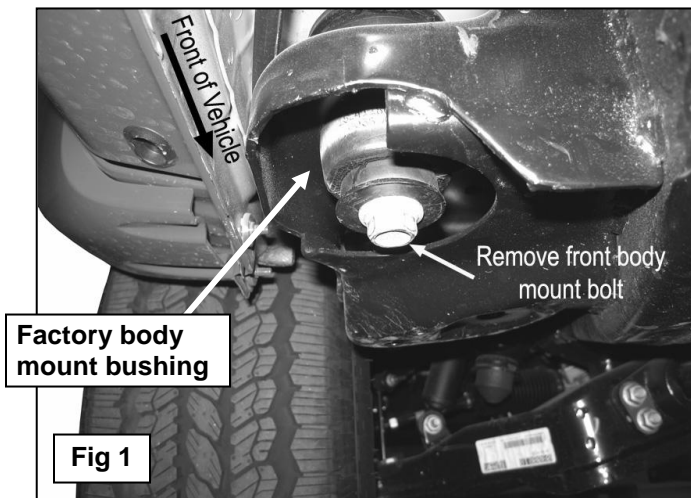

Driver Side Installation Pictured

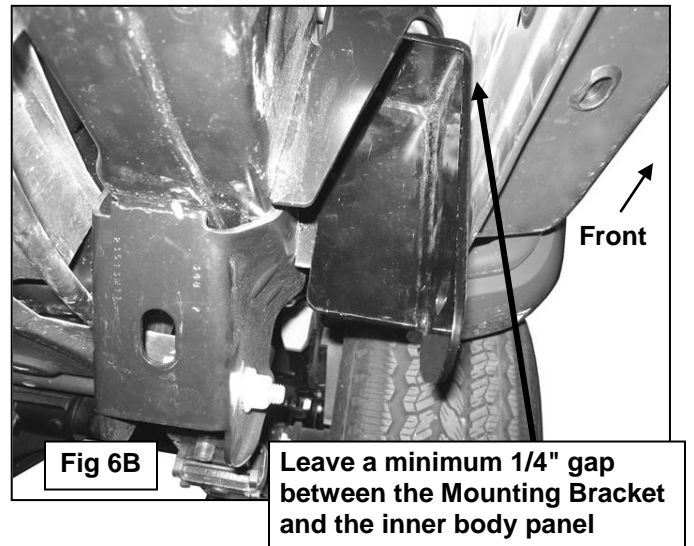
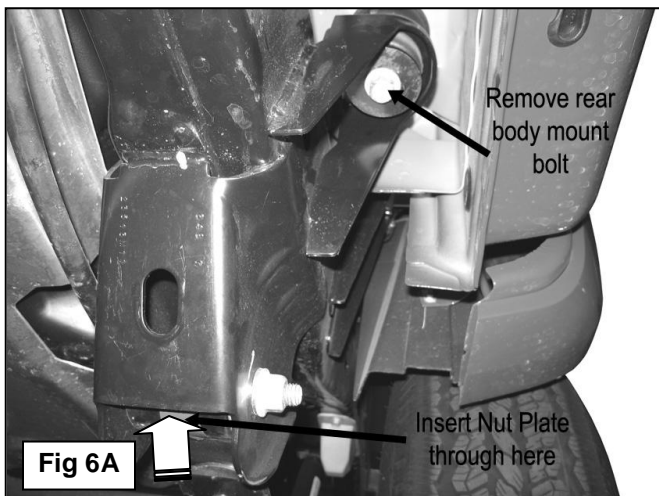
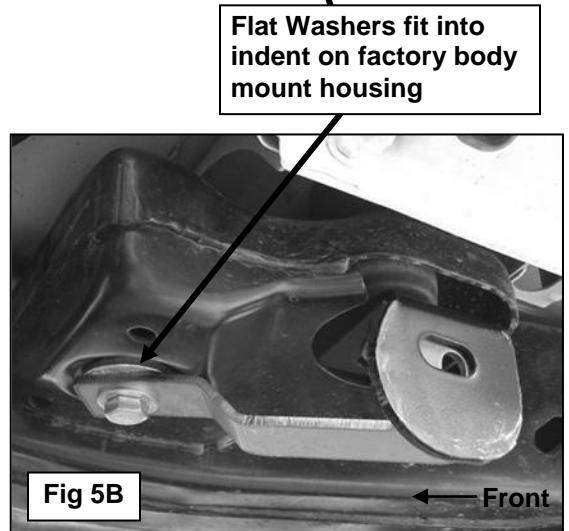
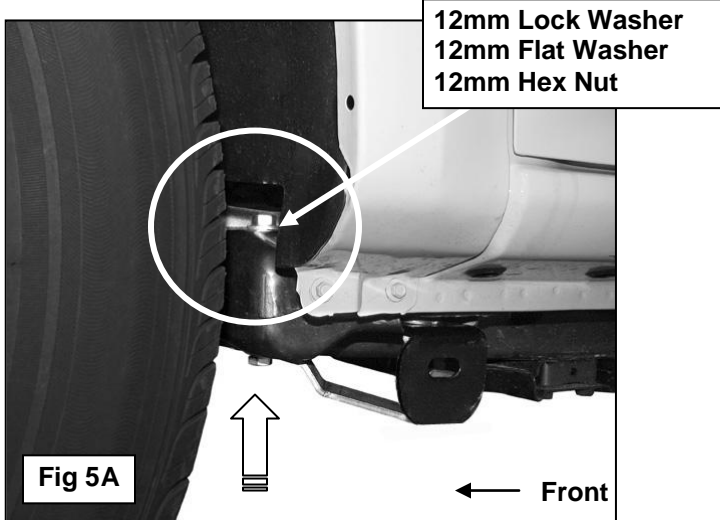
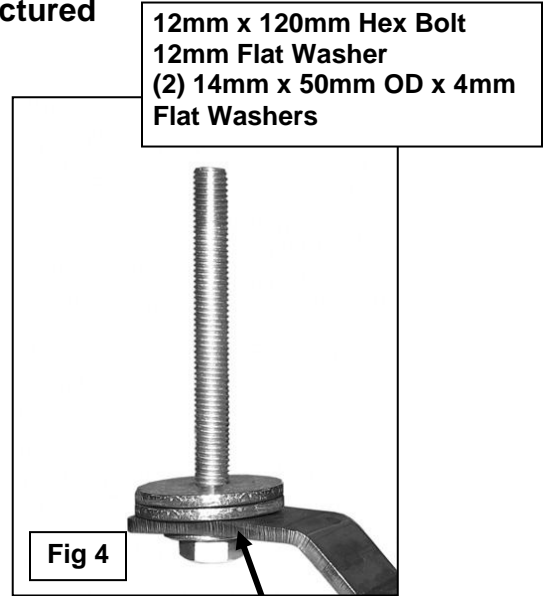
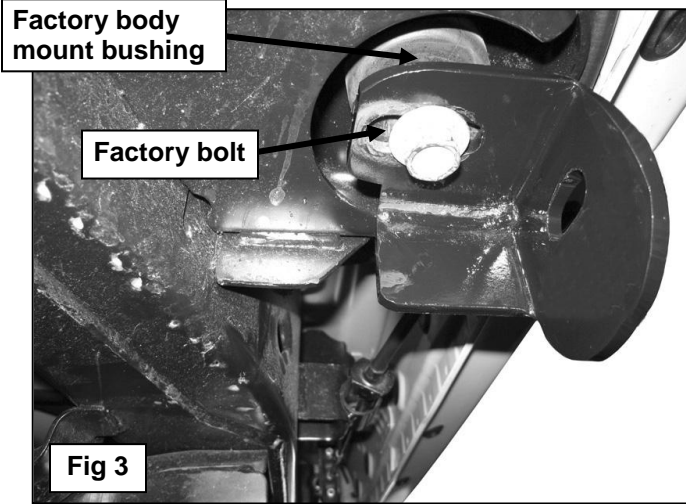

Driver Side Installation Pictured

