



INSTALLATION INSTRUCTIONS

SIDEBAR

07-15 WRANGLER 4DR

Part # 1-0923 1-5923

Parts List

1	Driver/Left Sidebar	6	10mm x 34mm OD x 3mm Flat Washers
1	Passenger/Right Sidebar	6	8-1.25mm x 35mm Hex Bolts
1	Driver/Left Front Mounting Bracket (medium length)	12	8-1.25mm x 25mm Hex Bolts
1	Passenger/Right Front Mounting Bracket (medium length)	18	8mm Lock Washers
1	Driver/Left Center Mounting Bracket (long)	12	8mm x 24mm OD x 2mm Flat Washers
1	Passenger/Right Center Mounting Bracket (long)	6	8mm x 28mm OD x 3mm Large Flat Washers
1	Driver/Left Rear Mounting Bracket (short)	12	6-1.0mm x 25mm Button Head Bolts
1	Passenger/Right Rear Mounting Bracket (short)	24	6mm ID x 18mm OD x 1.6mm Flat Washers
6	10mm Nut Plates	12	6mm Nylon Lock Nuts
6	10-1.5mm x 35mm Hex Bolts	1	4mm Allen Wrench
6	10mm Lock Washers		

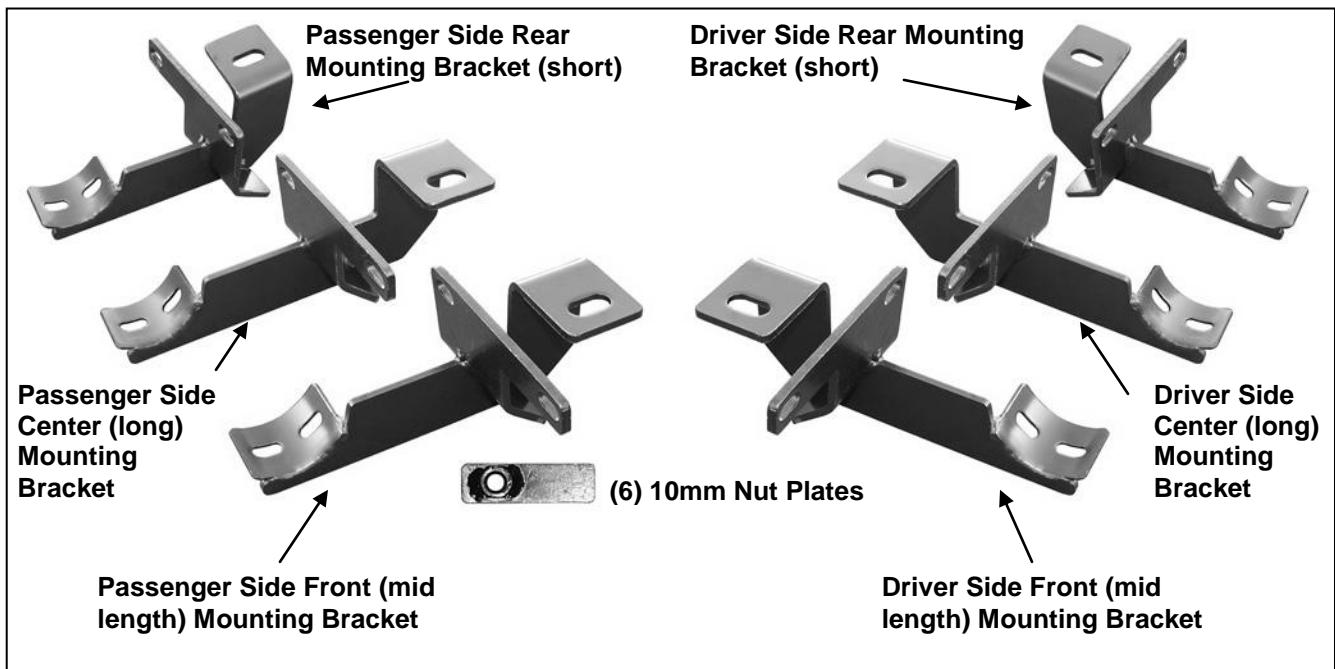

PROCEDURE:

- REMOVE CONTENTS FROM BOX. VERIFY ALL PARTS ARE PRESENT. READ INSTRUCTIONS CAREFULLY BEFORE STARTING INSTALLATION. FACTORY INSTALLED OR AFTERMARKET "ROCK RAILS," SIDE STEPS OR RUNNING BOARDS MUST BE REMOVED.**
- Start installation toward the front of the passenger side of the vehicle. Determine if the vehicle has an open floor panel or a threaded hole in the floor panel for the top tab on the Bracket, **(Figures 1 - 2)**. Remove any insulation that may be covering the mounting locations.
- Select the passenger side front Bracket. **VERY IMPORTANT:** The 6 Mounting Brackets look very similar. Use the instructions to properly identify the front, center and rear Brackets for either side of the vehicle. Each bracket has been designed for a specific location for proper installation.
 - Vehicles with open mounting location:** Insert (1) 10mm Nut Plate into the large square opening in the floor panel. Line up the threaded nut with the small hole in line with the tab on the Bracket, **(Figure 1)**. Bolt the Bracket to the Nut Plate with (1) 10mm x 35mm Hex Bolt, (1) 10mm Lock Washer and (1) 10mm Flat Washer, **(Figure 3A)**. Do not tighten hardware.
 - Vehicles with factory threaded hole in floor panel:** Bolt the tab on the Bracket to the threaded hole in the floor panel with (1) 8mm x 35mm Hex Bolt, (1) 8mm Lock Washer and (1) 8mm x 28mm OD Large Flat Washer, **(Figures 2 & 3A)**. Do not tighten hardware.
- Line up the mounting plate on the Bracket with the (2) factory holes in the pinch weld. Bolt the Mounting Bracket to the **back** of the pinch weld using the included (2) 6mm x 25mm Button Head Allen Bolts, (2)

6mm x 18mm Small Flat Washers, (against pinch weld), (2) 6mm x 22mm OD Large Flat Washers, (inside against the bracket), and (2) 6mm Nylon Lock Nuts, **(Figure 3A)**. Leave loose at this time.

5. Repeat **Steps 2 – 4** for Center and Rear Mounting Bracket installation. Use the instructions to correctly identify the Brackets, **(Figures 3B, 3C, 3D & 4)**.
6. Once all three Mounting Brackets are securely in position, place the passenger Sidebar onto the Mounting Brackets and secure it with the included (6) 8mm x 25mm Hex Bolts, (6) 8mm Lock Washers and (6) 8mm Flat Washers, **(Figure 5)**. **NOTE:** Mounting cradles on Brackets should be inline and pointing toward the rear of the vehicle for proper installation. Snug all hardware but do not tighten at this time.
7. Adjust and level the Sidebar and tighten all hardware.
8. Repeat **Steps 2 - 7** for driver/left Sidebar installation.
9. Do periodic inspections to the installation to make sure that all hardware is secure and tight.

To protect your investment, wax this product after installing. Regular waxing is recommended to add a protective layer over the finish. Do not use any type of polish or wax that may contain abrasives that could damage the finish.

For stainless steel: Aluminum polish may be used to polish small scratches and scuffs on the finish. Mild soap may be used also to clean the Sidebar.

For gloss black finishes: Mild soap may be used to clean Sidebar.

Passenger Side Installation Pictured

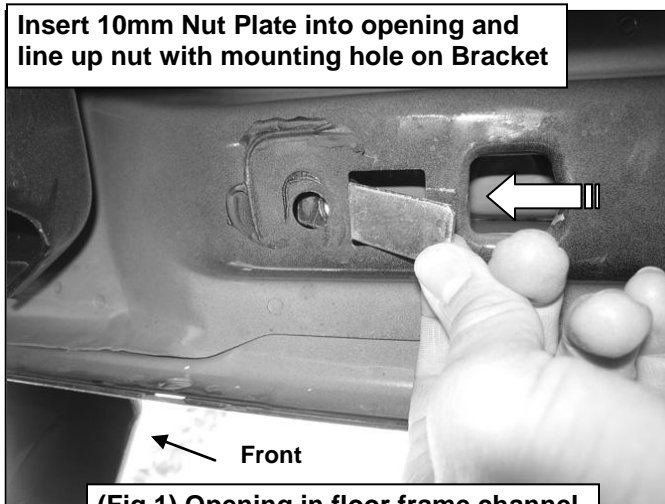

Insert 10mm Nut Plate into opening and line up nut with mounting hole on Bracket

(Fig 1) Opening in floor frame channel (passenger side-front pictured)



(Fig 2) 8mm threaded hole in floor frame channel (passenger side-front pictured for example)

- (2) 6mm x 25mm Button Head Bolts
- (2) 6mm Small Flat Washers (outside)
- (2) 6mm Large Flat Washers (inside)
- (2) 6mm Nylon Lock Nuts



(Fig 3A) Passenger side Front Mounting Bracket installation pictured ("mid length" bracket)

- 10mm Nut Plate
- 10mm x 35mm Hex Bolt
- 10mm Lock Washer
- 10mm Flat Washer
- OR
- 8mm x 35mm Hex Bolt
- 8mm Lock Washer
- 8mm x 28mm OD x 3mm Large Flat Washer

Passenger Side Installation Pictured

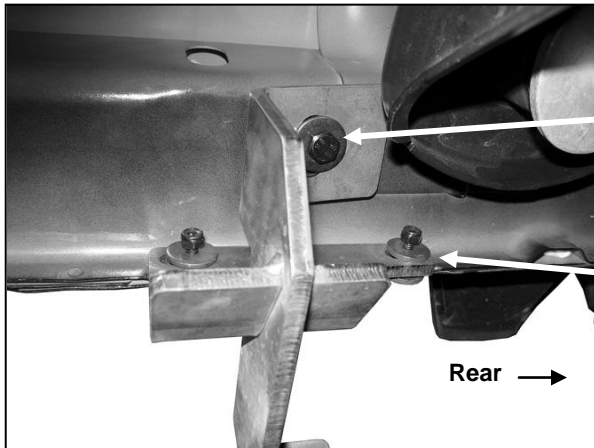
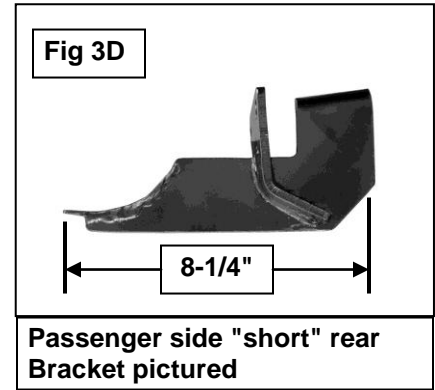
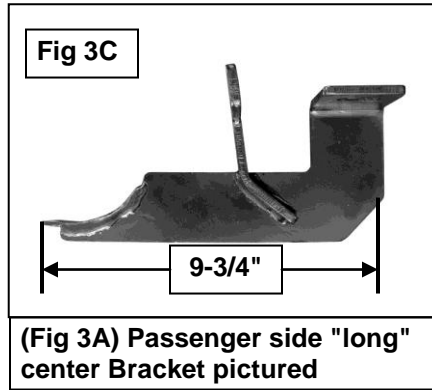
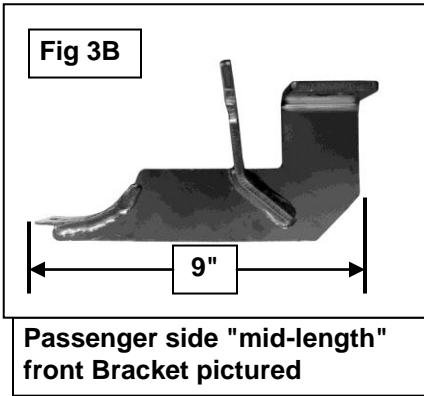

- 10mm Nut Plate
- 10mm x 35mm Hex Bolt
- 10mm Lock Washer
- 10mm Flat Washer
- OR
- 8mm x 35mm Hex Bolt
- 8mm Lock Washer
- 8mm x 28mm OD x 3mm Large Flat Washer

- (2) 6mm x 25mm Button Head Bolts
- (4) 6mm Flat Washers
- (2) 6mm Nylon Lock Nuts

(Fig 4) Passenger side Rear Mounting Bracket installation pictured (short bracket)

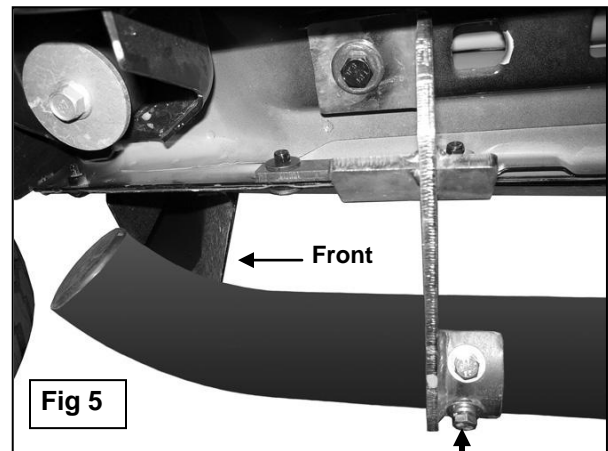

- (2) 8mm x 25mm Hex Bolts
- (2) 8mm Lock Washers
- (2) 8mm STD Flat Washers



Complete Installation