

ALSO AVAILABLE



VEHICLE GRILLE MOUNT KITS



ROOF MOUNTING KITS



MOUNTING KITS



REDED LENSES



NEOPRENE COVERS



AMBER LENSES



CANBUS SYSTEMS

WHAT'S INCLUDED

- 4x Grille Mounting Brackets
- 4x Cutter Guides
- Anti-Theft Fasteners & Key
- Fitting Instructions

Additionally - Kit Includes:

- 1x High Performance LED Spotlights (Triple-R 750)
- 1x Two-Lamp Wiring Kit

TOOLS REQUIRED

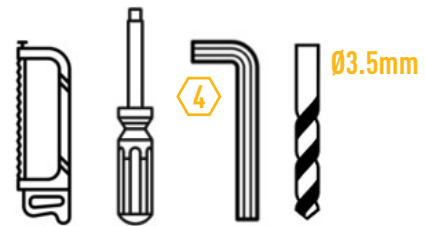

SIDE MOUNTING INFORMATION

It is advised to use an anti-seize compound or thread-lock when mounting from the side of the lamp(s).

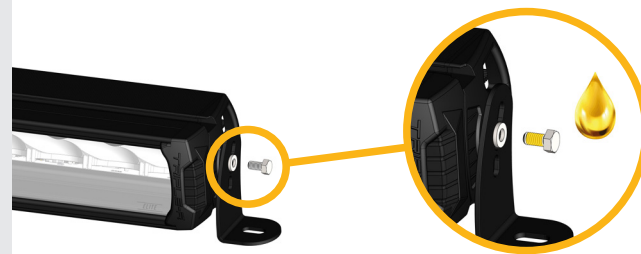

TRIPLE-R

HIGH PERFORMANCE LIGHTING



FORD RANGER 2019+ GRILLE INTEGRATION KIT

FITTING INSTRUCTIONS

TRIPLE-R

HIGH PERFORMANCE LIGHTING

WWW.TRIPLE-R-LIGHTS.COM

sales@triple-r-lights.com
Triple-R Lights LLC, 16192 Coastal Highway,
Lewes, Delaware, 19958, USA

 UK BUILT |  US DRIVEN    /TRIPLERLIGHTS

INSTALLATION PROCESS

Install should be completed with the grille left on the vehicle.

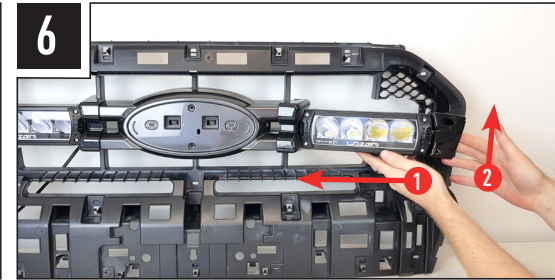
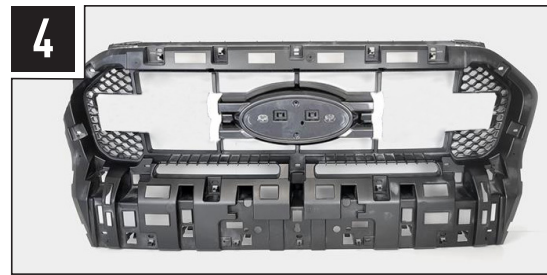
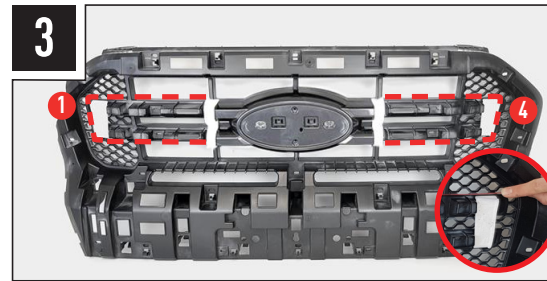
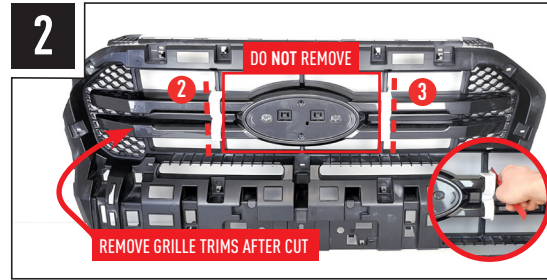
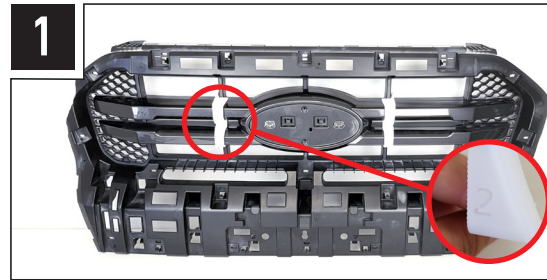

TORQUE VALUES

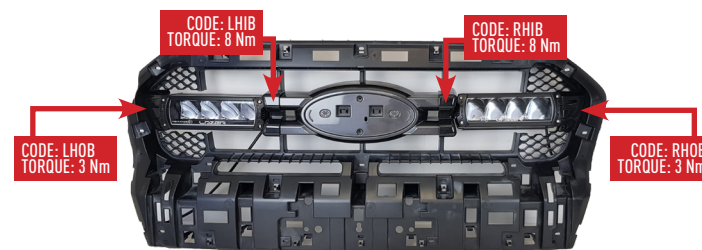

ELECTRICAL CONNECTION

LR-750 STANDARD

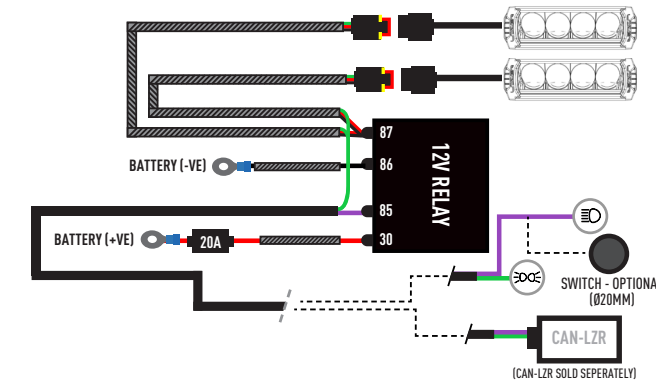

LR-750 ELITE

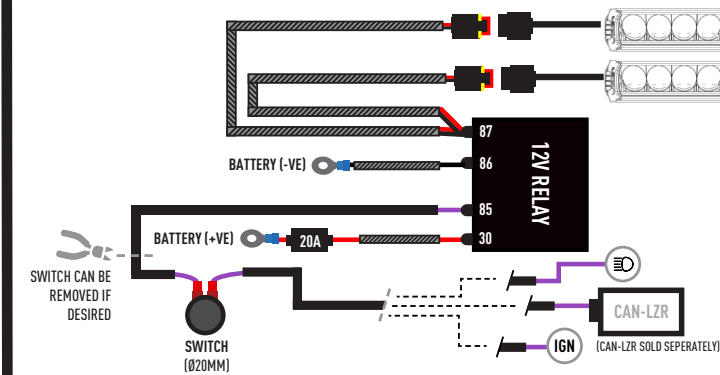

LR-SERIES - BACKLIGHT FUNCTION

The LR Series (Standard products only) come with the option to connect an amber or yellow backlight. For operation of either, connect the corresponding colored signal wire indicated below.

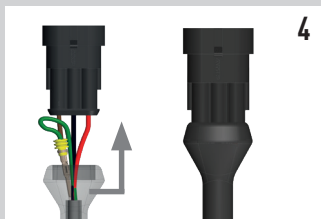
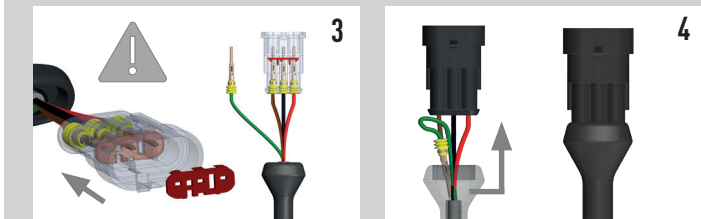
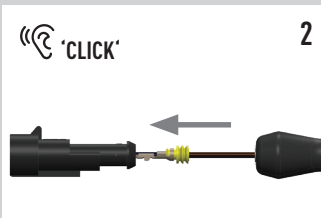

CANBUS INTEGRATION

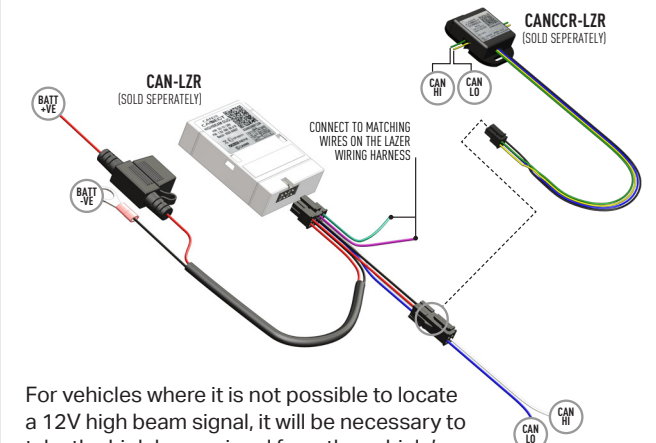

For vehicles where it is not possible to locate a 12V high beam signal, it will be necessary to take the high beam signal from the vehicle's CAN system. For vehicle specific CAN instructions, please download the "CANM8 Connect" App.