

ALSO AVAILABLE



VEHICLE GRILLE MOUNT KITS



ROOF MOUNTING KITS



MOUNTING KITS



REEDED LENSES



NEOPRENE COVERS



AMBER LENSES



CANBUS SYSTEMS

WHAT'S INCLUDED

- 2x Grille Mounting Brackets
- 2x Cutter Guides
- Anti-Theft Fasteners & Key
- Fitting Instructions

Additionally - Kit Includes:

- 1x High Performance LED Spotlight (Linear-18)
- 1x Single-Lamp Wiring Kit

TOOLS REQUIRED

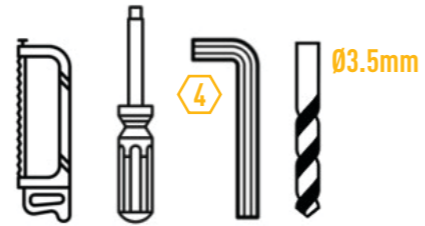

SIDE MOUNTING INFORMATION

It is advised to use an anti-seize compound or thread-lock when mounting from the side of the lamp(s).

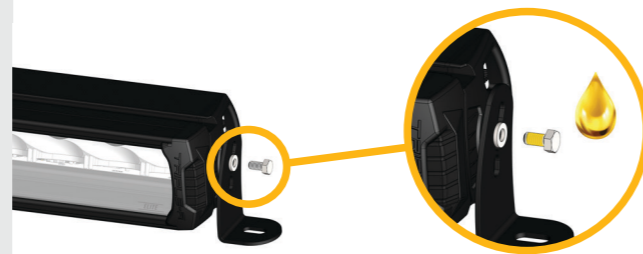

TRIPLE-R

HIGH PERFORMANCE LIGHTING



LAND ROVER DEFENDER (2020+)

GRILLE INTEGRATION KIT FOR LINEAR-18

FITTING INSTRUCTIONS

TRIPLE-R

HIGH PERFORMANCE LIGHTING

WWW.TRIPLE-R-LIGHTS.COM

sales@triple-r-lights.com

Triple-R Lights LLC, 16192 Coastal Highway,
Lewes, Delaware, 19958, USA

UK BUILT | US DRIVEN /TRIPLERLIGHTS

INSTALLATION PROCESS

Install should be completed with the grille left on the vehicle.

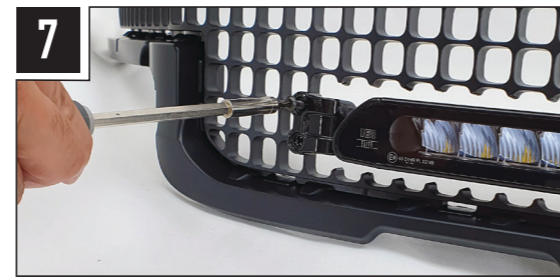
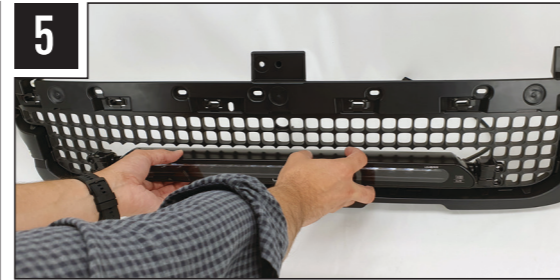
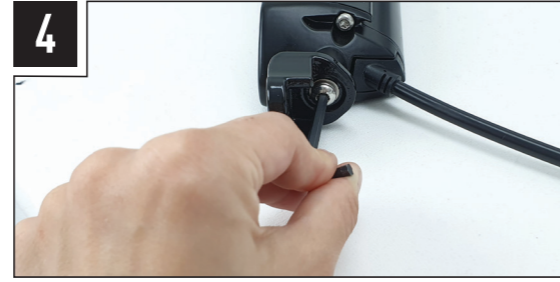
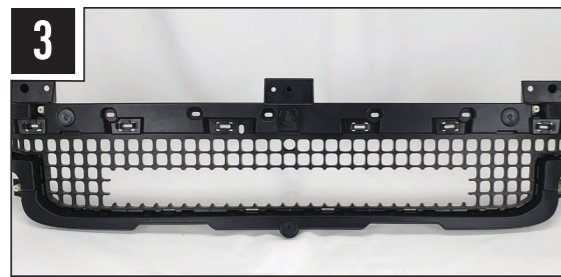
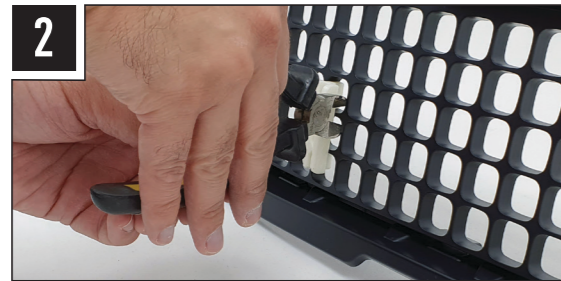
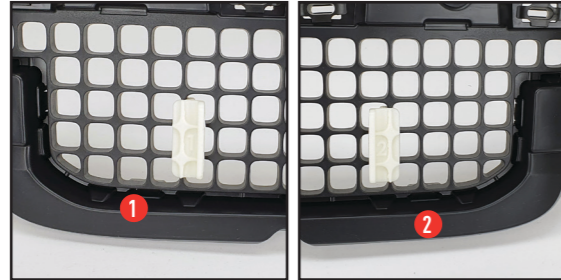

TORQUE VALUES



ELECTRICAL CONNECTION

LINEAR-18 STANDARD & ELITE

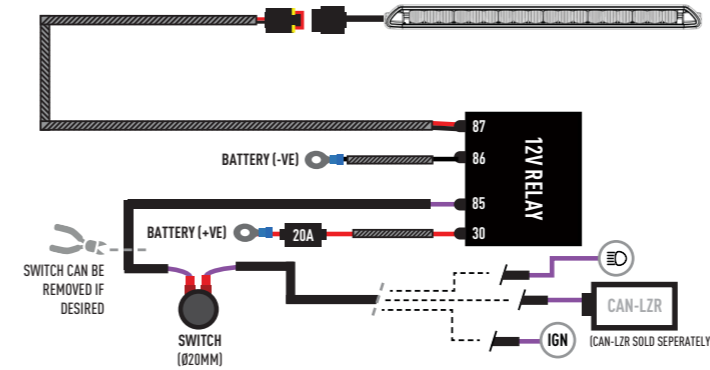

LINEAR-18 ELITE INTELLIGENT LOW BEAM ASSIST

Please refer to wiring instructions included with the lamp.

CANBUS INTEGRATION

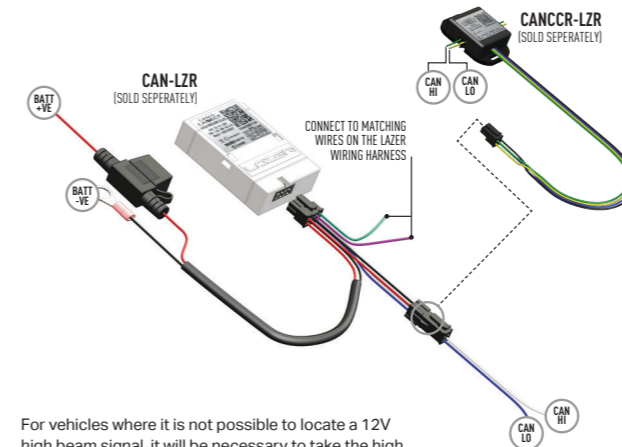

For vehicles where it is not possible to locate a 12V high beam signal, it will be necessary to take the high beam signal from the vehicle's CAN system. For vehicle specific CAN instructions, please download the "CANMB Connect" App.

