

"Lock It Or Lose It"™



MAX Security For ALL Applications!

RV's • Power Sports

Performance Trucks • Bicycles

Marine Trailer & Tow



A Division Of: **WYERS™**
Products Group, Inc.

"Lock It Or Lose It"

COLORADO BASED



"Committed To Providing The Highest Quality Solutions For ALL Our Customers' Security Needs"

Philip Wyers, President, CEO



EST. 1989



TRIMAX, a Registered Trademark of **Wyers Products Group, Inc.**, which was established in 1989 and is centrally located in Centennial, Colorado. **TRIMAX** remains committed to providing innovative solutions to our customers' security needs in the automotive and sports accessory markets.

Quality Designs



Through value added **in-house engineering**, **TRIMAX** prides itself on industry leading patented designs that hold up to the highest quality standards. All products have been rigorously tested before entering the world market.

Precision Machining - MADE IN THE USA



Industry Leading Aluminum Hitch Manufacturing



Engineering

CUSTOMER SUPPORT

TRIMAX stands behind every product it manufactures to assure customer satisfaction. We offer quality products supported by a professional staff trained to answer your questions and process your order in a time sensitive manner:

Customer service is #1.



TRIMAX

Adjustable Hitch Systems
Pages **4-11**

Receiver Pins
Pages **12-17**

Coupler Locks
Pages **18-23**

Cable Locks
Pages **24-27**

Chains/Cables
Pages **28-33**

U-Locks
Pages **34-37**

Disc Locks
Pages **38-40**

Padlocks
Pages **41-44**

Specialty Locks
Pages **45-48**

Bike Carriers
Pages **49-52**

Promotional
Pages **53-55**

PATENTED DESIGNS

All our operatives have a working knowledge of the patented products we provide and are happy to give the support required to keep our customers confident in our business relationship.



TRIMAX Team Members

TRIMAX is dedicated to supplying our customers the highest quality products, attractively packaged and manufactured in our own Colorado facility or around the world.



Shipping



Assembly

"Lock It Or Lose It"



INDUSTRY LEADING

ADJUSTABLE HITCH SYSTEMS

- 100% ALUMINUM INTEGRAL LOCKED XTR, HD & RP - ALL MADE IN THE USA!
- ALUMINUM FIXED BALL MOUNT HITCHES
- FORGED STEEL BLACK POWDER COATED
- TOW BALLS, ADAPTER SLEEVE



Made in the USA



TRIMAX

4

ADJUSTABLE HITCHES

"Lock It Or Lose It"™

RAZOR™ HITCHES



ALUMINUM Adjustable Hitches

Model **XTR**

Made In The USA



Aluminum
Ball Mount
Integral Locks
To Prevent
Theft

- 100% Solid Polished Aluminum
- Weight Tested To 10,000 Lbs.
1,500 Lbs. MAX Tongue Weight

Available In
3 Sizes -

- 6" - TRZ6AL
- 8" - TRZ8AL
- 12" - TRZ12AL

ADDED VALUE

Keyed Alike Receiver Lock
Included With XTR Hitches



- Flip Hitch For
Added Rise



- XTR Hitches
Include Dual
Hitch Tow Ball
(2" & 2-5/16")
- Easily Adjusts
Up & Down In
1" Increments

6"

8"

12"

TRIMAX™

"Lock It Or Lose It!"

RAZOR™ HITCHES

Strength / Function / Style™

2.5" & 3"
RAZOR™
HITCHES

COMING
IN 2018

ALUMINUM

Adjustable

HEAVY DUTY
HITCHES

Made In The USA



2.5" ALUMINUM
& 3" MAX HD
Model

5/8" Pin & Clip
HD Aluminum
Ball Mount In
1" Increments,
Rise Or
Drop

- 100% Solid Polished Aluminum
- Weight Tested To 20,000 Lbs.
2,000 Lbs. MAX Tongue Weight

2.5" Hitch Available
In 4 Sizes -

- 6" - TRZ6AL-HD
- 8" - TRZ8AL-HD
- 10" - TRZ10AL-HD
- 12" - TRZ12AL-HD

TRZ6AL-HD

3" Sleeve



TAS30

RAZOR-HD 3"
Adaptor Sleeve.
Converts 2-1/2"
RAZOR-HD
Adjustable
Hitches To
3" Receivers

HD Includes Dual Tow
Ball & 5/8" Pin/Clip.
Optional Keyed Alike
Lock Set Available -
TH45



TOW BALLS

- Extended Shank Length Designed
For HD Aluminum Hitches Only
- HD Tow Balls Available In Chrome
Steel Only



TRIMAX™

6

RAZOR HITCHES

"Lock It Or Lose It!"

RAZOR™ HITCHES

**PIN & CLIP
RAZOR
HITCHES**

**ALUMINUM
Adjustable
Hitches**

Model



Made In The USA



- 100% Solid Polished Aluminum
- Weight Tested To 10,000 Lbs.
1,500 Lbs. MAX Tongue Weight

**1/2" Pin & Clip
Aluminum Ball
Mount In 1"
Increments,
Rise Or
Drop**

**Available In
3 Sizes -**

- 4" - TRZ4AL-RP
- 6" - TRZ6AL-RP
- 8" - TRZ8AL-RP

**RP Includes Dual
Tow Ball & Pin/Clip.
Optional Keyed Alike
Lock Set Available**

**TRZ8AL-RP
Back**



- Flip Hitch
For Added
Rise

ACCESSORIES



RAZOR 2-1/2" Adapter Sleeve
Converts 2" RAZOR Adjustable
Hitches To 2-1/2" Receivers



TAS25

RAZOR Storage Bag
Fits All TIMAX Hitches
Except The MAX-HD



RZR BAG

**RP
Optional
Lock Pin
Set**



TRZ52

TRIMAX

"Lock It Or Lose It"™

RAZOR™ HITCHES

ADJUSTABLE HITCHES

Flip Ball Mount

- Easily Remove & Flip Double Ball Assembly To Change Ball Size.
- XTR Ball Mount Locks In Place For Added Security.



TRZ6AL-HD



XTR

ADDED VALUE

- Key Lock Ball Mount. Keyed Alike Receiver Lock Included



- 2" Receiver Hitch
- Weight Tested To 10,000 Lbs, 1,500 Lbs Tongue Weight

RP

- 1/2" Pin & Clip Aluminum Ball Mount



Locking Pin Set Available - TRZ52



- 2" Receiver Hitch
- Weight Tested To 10,000 Lbs, 1,500 Lbs Tongue Weight

2.5" ALUMINUM & 3" MAX HD

- 5/8" Pin & Clip Aluminum Ball Mount



Locking Pin Set Available - TH45



- 2-1/2" Receiver Hitch
- Weight Tested To 20,000 Lbs, 2,000 Lbs Tongue Weight

ADJUSTABLE HITCHES



ALUMINUM SPECS

Part No:	ALUMINUM RAZORS
TRZ6AL	6" Aluminum Drop Hitch w/Locking Ball Mount Receiver Pin - Dual Hitch Ball Included
TRZ8AL	8" Aluminum Drop Hitch w/Locking Ball Mount Receiver Pin - Dual Hitch Ball Included
TRZ12AL	12" Aluminum Drop Hitch w/Locking Ball Mount Receiver Pin - Dual Hitch Ball Included
TRZ4AL-RP	4" Aluminum Drop Hitch, Pin & Clip - Dual Hitch Ball Included
TRZ6AL-RP	6" Aluminum Drop Hitch, Pin & Clip - Dual Hitch Ball Included
TRZ8AL-RP	8" Aluminum Drop Hitch, Pin & Clip - Dual Hitch Ball Included
TRZ6AL-HD	6" Aluminum Drop Hitch, Pin & Clip - Dual Hitch Ball Included
TRZ8AL-HD	8" Aluminum Drop Hitch, Pin & Clip - Dual Hitch Ball Included
TRZ10AL-HD	10" Aluminum Drop Hitch, Pin & Clip - Dual Hitch Ball Included
TRZ12AL-HD	12" Aluminum Drop Hitch, Pin & Clip - Dual Hitch Ball Included
ACCESSORIES	
TAS25	2-1/2" to 2" Class V Adaptor Sleeve
TAS30	3" to 2-1/2" Class V Adaptor Sleeve
TRZ52	Razor-RP Locking Pin Set, 1/2"x3-5/8", 5/8"x3-1/2", Keyed-Alike
TH45	Razor-HD Locking Pin Set, 5/8"x4-3/16", 5/8"x3-1/2", Keyed-Alike
RZR BAG	TRIMAX RAZOR Adjustable Hitch Towing Bag

TOW BALLS

- Extended Shank Length Designed For Aluminum Hitches Only



RP & XTR Available In Chrome & Stainless Steel

Part No:	
TBAL2	2" Tow Ball Chrome
TBAL2516	2-5/16" Tow Ball Chrome
TBSXAL2	2" Tow Ball Stainless Steel
TBSXAL2516	2-5/16" Tow Ball Stainless Steel
TDBAL22516	2" & 2-5/16" Double Tow Ball Chrome
TDBSXAL22516	2" & 2-5/16" Double Tow Ball Stainless Steel



HD Available In Chrome Only

Part No:	
TBHD2	2" Tow Ball Chrome
TBHD2516	2-5/16" Tow Ball Chrome
TDBHD22516	2" & 2-5/16" Double Tow Ball Chrome

"Lock It Or Lose It!"

RAZOR HITCHES

**ADJUSTABLE
LOCKING
HITCHES**

- Powder Coated Forged Steel



**FORGED STEEL
Adjustable
Hitches**



- Ball Mount Adjusts Up & Down In 1" Increments - Locks In Place

- Locking Ball Mounts For Added Security

- Weight Tested To 10,000 Lbs. 1,500 Lbs. MAX Tongue Weight

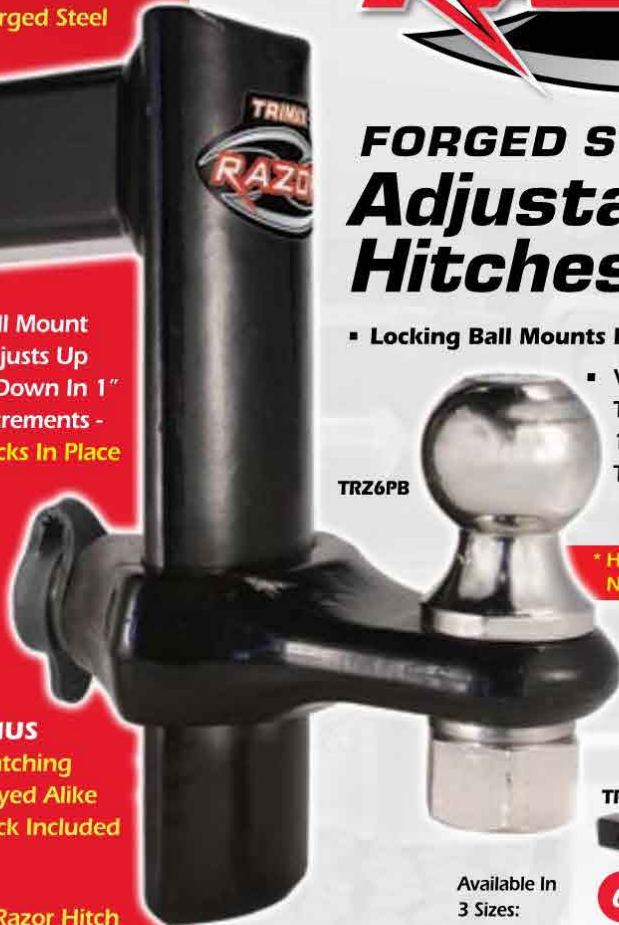

TRZ6PB

* Hitch Ball NOT Included

6"

8"

12"

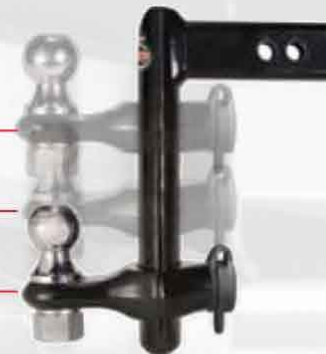

BONUS

- Matching Keyed Alike Lock Included

Flip Razor Hitch For Added Rise

Available In 3 Sizes:

TRZ6PB

6"

TRZ8PB

8"

TRZ12PB

12"



Part No:

STEEL RAZORS

TRZ6PB Deluxe 6" Powder Coat Black Drop Hitch

TRZ8PB Deluxe 8" Powder Coat Black Drop Hitch

TRZ12PB Deluxe 12" Powder Coat Black Drop Hitch

ADDED VALUE

Keyed Alike Receiver Lock Included With PB Hitches



Hitch Ball NOT Included With Steel Razors

Tow Balls Available In Chrome Or Stainless Steel

Part No:

TOW BALLS

TBC2 2" Tow Ball Chrome

TBC2516 2-5/16" Tow Ball Chrome

TDBC22516 2" & 2-5/16" Double Tow Ball Chrome

TBSX2 2" Tow Ball Stainless Steel

TBSX2516 2-5/16" Tow Ball Stainless Steel

TDBSX22516 2" & 2-5/16" Double Tow Ball Stainless Steel



2" & 2-5/16"

2"

2-5/16"

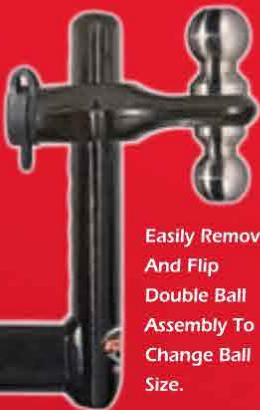

Easily Remove And Flip Double Ball Assembly To Change Ball Size.

TRIMAX

RAZOR HITCHES

"Lock It Or Lose It"

RAZOR™ HITCHES

ALUMINUM HITCHES

FIXED MOUNT



- Flip Hitch For Added Rise



- 100% Forged Aluminum For Unmatched Strength
- Fits All 2" Receivers
- Weight Tested To 8,000 Lbs. 800 Lbs. MAX Tongue Weight

Available In 5 Sizes -

- 2" - TRZ2ALFM
- 4" - TRZ4ALFM
- 6" - TRZ6ALFM
- 8" - TRZ8ALFM
- 10" - TRZ10ALFM

- Combine With T3 Receiver Pin For Added Security

TRZ10ALFM 10"

TRZ8ALFM 8"

TRZ6ALFM 6"

TRZ4ALFM 4"

TRZ2ALFM 2"



- 5 Models

- Tow Ball Not Included

Part No:

- TRZ2ALFM** 2" Forged Aluminum Fixed Ball Mount
- TRZ4ALFM** 4" Forged Aluminum Fixed Ball Mount
- TRZ6ALFM** 6" Forged Aluminum Fixed Ball Mount
- TRZ8ALFM** 8" Forged Aluminum Fixed Ball Mount
- TRZ10ALFM** 10" Forged Aluminum Fixed Ball Mount

TRIMAX

RAZOR HITCHES

"Lock It Or Lose It"



RECEIVER PINS

- LOCKING RECEIVER PINS
- KEYED & COMBINATION MODELS
- FLIP-TIP & PIN & CLIP



TRIMAX

LOCKING RECEIVER PINS

TS32 -
Chrome Steel
SXTS32-
Stainless Steel

- **Ideal For Securing:**
Hitch Receivers,
Bike Carriers,
Ornamental
Receiver Plugs
& Swing Away
Trailer Hitches

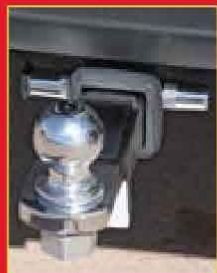

PATENTED

Dare To Compare! TRIMAX, The Absolute Leader in Receiver Locking Pin Technology. **TRIMAX** has spent the last 15 years expanding and improving on the "Original", patented Dual Lock Lug Design. **Look Alikes, Do Not Lock Alike!**
Buy only TRIMAX branded parts.

Patented UNIVERSAL Receiver Pin
Fits Class III (5/8") Or Class II (1/2")

- Eliminate Returns
- Always The Correct Size

Patented Design Incorporates Internal
O-ring & Water Tight Cap
Helps To Seal Out Dirt



Machined From
100% Solid Stainless
And/Or Forged Steel

Removable 5/8" Sleeve

Large 1/2" Dual Lock Lugs
Prevent False Locking-Lock
Can't Pop Open

- Patented 1/4 Turn Design Prevents False Locking, Won't POP Open
- **TESTED SPECIFICATIONS EXCEEDS**
40,000 LBS. (Stainless), 32,000 LBS. (Steel)



Part No:

- TS32** Universal Receiver Lock - Fits 1/2" & 5/8", W/Sleeve
- SXTS32** 100% Stainless Steel Universal Receiver Lock & Sleeve - Fits 1/2" & 5/8"
- T2** Machine Forged Chrome Steel, 1/2" x 2-3/4" Span
- T3** Machine Forged Chrome Steel, 5/8" x 2-3/4" Span
- T3-Black** Premium 5/8" Key Receiver Lock, Rugged Black Epoxy Powder Coat
- T5** Machine Forged Chrome Steel, 5/8" x 3-1/2" Span Fits Class V Hitches
- T5-Black** Premium 5/8" Key Receiver Lock, Rugged Black Epoxy Powder Coat, 3-1/2" Span Fits Class V Hitches
- TH4** Machine Forged Chrome Steel, Adjustable Hitch Lock, 5/8" x 4-3/8" Span
- TH6** Machine Forged Chrome Steel, 5/8" x 6-1/8" Span, Swing Away Trailer Lock

- TH43** 'Rapid Hitch' Keyed-Alike Adjustable Receiver Lock Set
- TH45** Keyed-Alike Adjustable Receiver Lock Set, Includes T5 and TH4
- TRZ52** Keyed-Alike RazorAL-RP Receiver Lock Set, Includes T5 and 1/2" x 3-5/8" Span Pin.
- SXTRZ52** 100% Stainless Steel Keyed-Alike RazorAL-RP Receiver Lock Set, Includes T5 and 1/2" x 3-5/8" Span Pin.

"Lock It Or Lose It"

LOCKING RECEIVER PINS

Tested Specifications For Towing Exceed 40,000 Lbs. Double Shear Load

LOCKING PINS

Ideal For Limited Access Receiver Areas



100% STAINLESS STEEL



SXT3

SXT5

Wider Span

Fits Class V Hitches!

- 3-1/2" Span Fits The New Wider Toyota, Ford And Chevy Receivers
- All Locking Pins Include 2 Keys

Part No:

SXT3

Premium 100% Stainless Steel 5/8" Key Receiver Lock

SXT5

Premium 100% Stainless Steel 5/8" Class V Key Receiver Lock - 3-1/2" Span

RIGHT ANGLE



- Water Tight Cap Helps Seal Out Dirt

- Stainless Steel Internal Components

- Rugged Dual Locking Design Can't Be False Locked

TRA3

- Fit 2-1/2" Span

TRA5

- Fit 3-1/2" Span

Wider Span

Fits Class V Hitches!

Part No:

TRA3

Machine Forged Chrome Steel, 5/8" x 2-3/4" Span

TRA5

Machine Forged Chrome Steel, 5/8" x 1-3/2" Span

TRIMAX

"Lock It Or Lose It"

RECEIVER PINS

HOLLOW CORE

LOCKING ANTI-RATTLE PINS

Easily Adjust
And Lock Receiver
Pin For Tight,
Quiet Fit

Available In 2"



▪ Includes 2 Keys

INSTALLATION

1. Install Lock Nut Carriage Into Draw Bar, Align With Holes
2. Slide Draw Bar Into Receiver. Insert Lock Pin And Tighten
3. Insert 5/8" Head And Attach Lock Head

Part No:

TAR300 Premium 5/8" Anti-Wobble Key Receiver Lock, For 2" Hitch

EASY TO INSTALL



▪ Includes Installation Wrench

Draw Bar

TAR300 - 2" Hitch

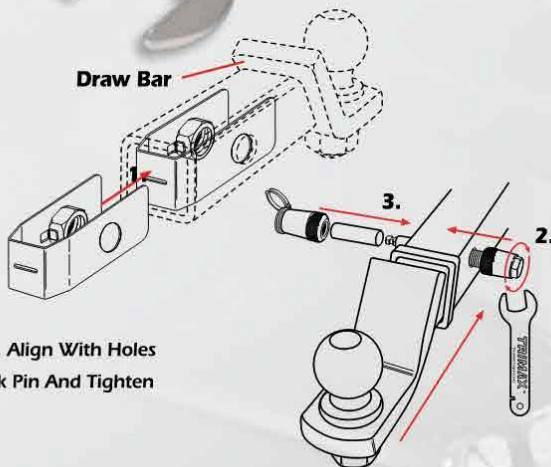

UNIVERSAL

HOLLOW & SOLID CORE

ANTI-RATTLE CLAMP



Available In
2" And 2-1/2"

EASY TO INSTALL

COMING IN 2017



(Receiver Hitch)

Easily Adjust
Receiver Pin
For Tight,
Quiet Fit



THC250 - 2-1/2" Hitch
THC200 - 2" Hitch

Part No:

THC200 UNIVERSAL Anti-Rattle Clamp For 2" Draw Bar

THC250 UNIVERSAL Anti-Rattle Clamp For 2-1/2" Draw Bar

TRIMAX

"Lock It Or Lose It"

RECEIVER PINS

LOCKING RECEIVER PINS

TR200 Wider Span Fits The New Toyota, Ford & Chevy Receivers

UNIVERSAL FIT



Wider Span
Fits Class V Hitches!

- 1/2" Pin Fits All Class II Receiver Hitches

Part No:

TR200 Deluxe 5/8" Key Receiver Lock, 3-1/2" Span

TR125 Deluxe 1/2" Key Receiver Lock, Fits 1-1/4" Class II Receivers

LOCKING PIN

TWISTER SERIES



TK225

- Chrome Plated Steel 5/8" Pin Fits All Class III, IV And V 2" x 2" Receivers

Exclusive Twisting Head

- Twisting Lock Head Makes Lock Resistant To Saw Cuts

Part No:

TK225 Twister Series 5/8" Key Receiver Lock

COMBO LOCKING PIN

Durable Non-Corrosive Locking Mechanism

RESETTABLE

Set Your Own Personalized Combination

- Heavy-Duty Collar Overlaps Hitch Pin For Unmatched Strength And Security
- Triple Chrome Plated Steel Pin



MAG200

MAG125

- Protective Lock Head Cover Included

Part No:

MAG200 Resettable Combination Receiver Lock, 5/8"

MAG125 Resettable Combination Receiver Lock, 1/2"

TRIMAX

"FLIP-TIP" PINS

Available In
Chrome Or
Stainless Steel

QUICK INSTALL

TX125
SXTX125

- 1/2" Pin Fits All Class I & II Receivers

TX200
SXTX200

- 5/8" Pin Fits All Class III, IV & V Receivers

Part No:

Triple Chrome Plated

TX125 Chrome Plated "FLIP-TIP" 1/2" Receiver Pin & Clip

TX200 Chrome Plated "FLIP-TIP" 5/8" Receiver Pin & Clip

Stainless

SXTX125 Premium Stainless Steel "FLIP-TIP" 1/2" Receiver Pin & Clip

SXTX200 Premium Stainless Steel "FLIP-TIP" 1/2" Receiver Pin & Clip

Easy To Install

1. Squeeze Tip & Push Down Head
2. Rotate Tip Forward For Insertion Into Or Removal From Receiver
3. Once Pin Is Through Receiver Hole, Rotate Tip Downward Until Tip "SNAPS" Firmly Into Place

PIN & CLIP

Triple Chrome Plated

SP125

- 1/2" Pin Fits All Class I & II Receivers

SP200

- 5/8" Pin Fits All Class III, IV & V Receivers

SP358

- 1/2" x 3-5/8" Pin Fits RazorAL-RP Adjustable Ball Mounts

SP434

- 5/8" x 4-3/4" Pin Fits RazorAL-HD Adjustable Ball Mounts

Part No:

SP125 Steel Pin & Clip 1/2" Receiver Pin

SP200 Steel Pin & Clip 5/8" Receiver Pin

SP358 Steel Pin & Clip 1/2" x 3-5/8" Span For RazorAL-RP Ball Mounts

SP434 Steel Pin & Clip 5/8" x 4-3/4" Span For RazorAL-HD Ball Mounts

"Lock It Or Lose It"



COUPLER LOCKS

- UNATTENDED COUPLER LOCKS
- KEYED ALIKE SETS
- MULTI-USE, ADJUSTABLE, STAINLESS STEEL



TRIMAX

"Lock It Or Lose It!"

UNIVERSAL COUPLER LOCK

PATENTED DUAL LOCK TECHNOLOGY

**360° OF
HARDENED
STEEL
PROTECTION**

**UNIVERSAL FIT
Coupler Locks**



Dual Force Security
Combine With
TRIMAX Chains
& Cables



**FIT MOST
COUPLERS!**

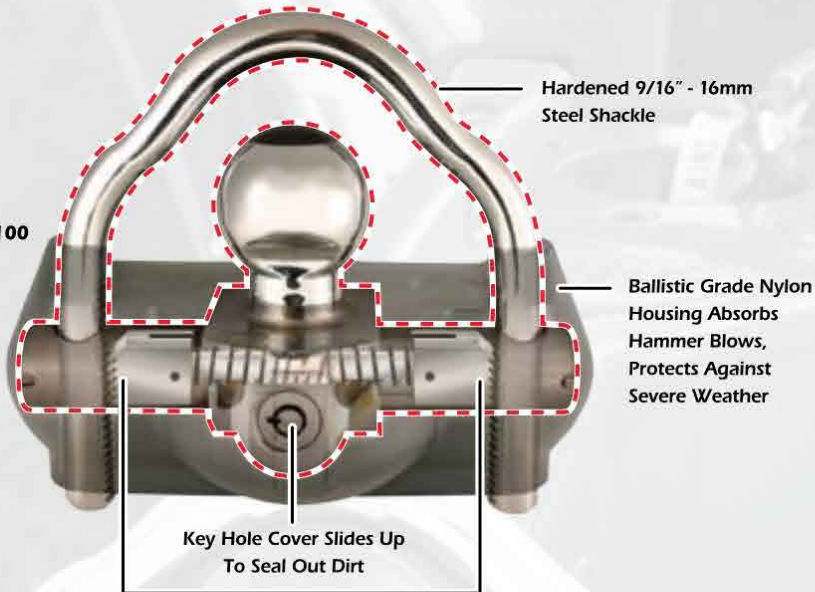

Unmatched Patented Dual Lock System
Huge 7 Tooth, 3/8" Wide Locking Lug System
On UMAX50 & UMAX100

Covered By US Patent #7, 121, 121

Good



UMAX25 -
1/2" Hardened Steel Shackle

Better



UMAX50 -
9/16" Hardened Steel Shackle

Best



UMAX100 -
9/16" Hardened Steel Shackle

▪ Extra Security For Unattended Trailers. Three Models To Fit All Your Security Needs
"Never Buy A Single Latch Coupler Lock!"

Part No:

UMAX25 **NEW** UNIVERSAL 'Die-Cast' Patented Dual Locking Narrow Body Coupler Lock, 1/2" Shackle

UMAX50 Deluxe UNIVERSAL 'Die-Cast' Patented Dual Locking Coupler Lock, 9/16" Shackle

UMAX100 Premium UNIVERSAL 360° Of "Solid Hardened Steel" Patented Dual Purpose Coupler Lock, 9/16" Shackle

"Lock It Or Lose It!"

COUPLER LOCKS

TOWING KITS

One Key Fits All Three Locks!

KEYED ALIKE

TCP50

TCP100



- Keyed Alike Latch Lock, Receiver Hitch Lock And Coupler Lock Deliver Complete Security All In One Convenient Package
- Two High Security Coupler Locks To Choose From



▪ Includes 6 Keyed Alike Keys

Towing Kits Include:

▪ TCP50

UMAX50



▪ TCP100

UMAX100



UNIVERSAL Receiver Lock
TS32



ADJUSTABLE Coupler Lock
TC123



Carrying Case

Part No:

TCP50

Combo Pack Keyed Alike Set, Includes UMAX50, TC123 - Adjustable Coupler Lock Fits Couplers From 7/8", 2-1/2" To 3-1/2" Spans, TS32- 5/8" or 1/2" Universal Receiver Lock

TCP100

Combo Pack Keyed Alike Set, Includes UMAX100, TC123 - Adjustable Coupler Lock Fits Couplers From 7/8", 2-1/2" To 3-1/2" Spans, TS32 - 5/8" or 1/2" Universal Receiver Lock

TRIMAX

"Lock It Or Lose It!"

COUPLER LOCKS

COUPLER TRIGGER

Great For Trailer Door Latches, Couplers And Cargo Boxes

TMC10



- Easy 1/4 Turn Of Key Lock & Unlock For Maximum Security
- Internal O-RING In Lock Body & Weather Proof Cap Help Seal Out Grime & Corrosion



Dual Force Protection When Combined With UMAX25/50/100



- Includes 2 Keys



Part No:

TMC10 Deluxe Coupler/Door Latch Lock, Fits Couplers W/Up To 7/8" Span

MACHINED LOCKING PINS

HARDENED STEEL

TC123



- Slides To Fit 7/8", 2-1/2" & 3-1/2" Spans
- Full Length Pin Made Of 100% Stainless Steel
- Includes 2 Keys



Part No:

TC1 Coupler/Door Latch Lock, Fits Couplers w/Up To 7/8" Span

TC2 Coupler Lock, Fits Couplers w/Up To 2-1/2" Span

TC3 Coupler Lock, Fits Couplers w/Up To 3-1/2" Span

TC123 Adjustable Coupler Lock, Fits Couplers From 7/8", 2-1/2" To 3-1/2" Spans

TRIMAX

"Lock It Or Lose It!"

COUPLER LOCKS

LOCKING PINS

Stainless Steel
Internal
Components



- Patented Design Incorporates O-Ring & Water Tight Cap To Help Seal Out Dirt & Corrosion



100% STAINLESS STEEL



SXTC1

- Fit 7/8" Span



SXTC2

- Fit 2-1/2" Span

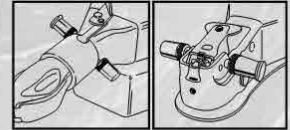

SXTC3

- Fit 3-1/2" Span

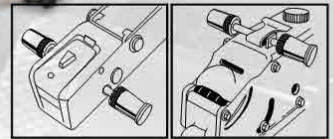

- Full Length Pin Made Of Solid Forged Stainless Machined Steel



- Includes 2 Keys

SXTC123



- Slides To Fit 7/8", 2-1/2" & 3-1/2" Spans

- Easy Operation, 1/4 Turn Locks & Unlocks Head
- Large Dual Lock Lugs. Can't "POP" Open Or Be Falsely Locked

Part No:

- SXTC1** Premium Stainless Steel Coupler/Door Latch Lock, 7/8" Span
- SXTC2** Premium Stainless Steel Coupler Lock, Fits Couplers w/Up To 2-1/2" Span
- SXTC3** Premium Stainless Steel Coupler Lock, Fits Couplers w/Up To 3-1/2" Span
- SXTC123** Adjustable Stainless Steel Coupler Lock, Fits 7/8", 2-1/2" To 3-1/2" Spans

TRIMAX

KEYED ALIKE SETS

Polished Chrome Steel

- One Key Operates Both Locks, Multiple Sets Available



- All Sets Includes 4 Keys



KEYED ALIKE SETS

Polished Stainless Steel

POLISHED CHROME STEEL



TM31



TM32



TM33



TM3123



TM5123



TMC3310

Part No:

- TM31** T3 - 5/8" Receiver Lock & TC1 - 7/8" Span Coupler Lock
- TM32** T3 - 5/8" Receiver Lock & TC2 - 2-1/2" Span Coupler Lock
- TM33** T3 - 5/8" Receiver Lock & TC3 - 3-1/2" Span Coupler Lock
- TM3123** TS32 - Universal Fit Locking Pin & TC123 - Adjustable Coupler Lock
- TM5123** T5 - 5/8" Receiver Lock - 3-1/2" Span & TC123 - Adjustable Coupler Lock
- TMC3310** (2) T3'S - 5/8" Receiver Lock & TMC10 3/4" Span Coupler Lock

100% STAINLESS STEEL



SXTM31



SXTM32



SXTM33



SXTM3123

- Unmatched Beauty, Strength & Rust Resistance

Part No:

- SXTM31** Stainless Steel SXT3 - 5/8" Receiver Lock & SXTC1 - 7/8" Span Coupler Lock
- SXTM32** Stainless Steel SXT3 - 5/8" Receiver Lock & SXTC2 - 2-1/2" Span Coupler Lock
- SXTM33** Stainless Steel SXT3 - 5/8" Receiver Lock & SXTC3 - 3-1/2" Span Coupler Lock
- SXTM3123** Stainless Steel SXTS32 - Universal Fit Locking Pin & SXTC123 - Adjustable Coupler Lock

"Lock It Or Lose It"



CABLE LOCKS

- VERSA-CABLE
- MULTI-PURPOSE LOCKS
- BICYCLE LOCKS



TRIMAX

"Lock It Or Lose It"

VERSA-CABLE LOCK

VERSA-CABLE LOCK

MOVEABLE/CINCHABLE

Cinch It Tight Here!

10mm Locking Tip Fits Through Small Openings



- 10mm TRIMAFLEX™ Vinyl Coated Cable
- Moveable, Cinchable Lock Head Adapts To Many Applications
- Interchangeable Cables Available In 12' And 30' Lengths

Recommended Uses:

- Bicycles
- Power Tools
- Patio Furniture
- BBQ Grills
- Sports Equipment
- Fire Arms
- Power Sports
- Marine Toys: Wakeboards, Towables, Jet Skis, Coolers & More!

VMAX6
Yellow

VMAX9C
Camo

The Big Squeeze

Get Creative!

The Quick Weave

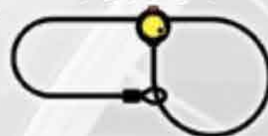

The Dual Loop

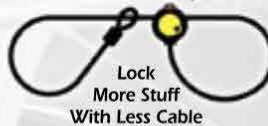

Lock More Stuff With Less Cable

The Big Easy Standard Big Loop



The Long Shot



- Cables Only - Lock Not Included



VMAX12CBL
12' Length



VMAX30CBL
30' Length

Part No:

VMAX6

VMAX9C

VMAX12CBL

VMAX30CBL

VMAXHD

Multi-Use Versa-Cable Lock, 6' x 10mm TRIMAFLEX™ Cable

Multi-Use Versa-Cable Camo Lock, 9' x 10mm TRIMAFLEX™ Cable

TRIMAFLEX™ Replacement Cable 12' (L) x 10mm (Cable Only)

TRIMAFLEX™ Replacement Cable 30' (L) x 10mm (Cable Only)

Multi-Use Versa-Cable Lock Head



PDO

TRIMAX

"Lock It Or Lose It!"

CABLE LOCKS

SPARE TIRE LOCKS

Lock System Loops Around Welded Frame Member Of Trailer Or Automobile Frame

MULTI-PURPOSE



- Ideal For Securing Spare Tires On Jeeps, Boat Trailers, Trucks & Vans

Part No:

ST30 TRIMAFLEX Spare Tire Cable Lock (Round Key) 36" x 12mm



- Locks Through Wheel Lug Nut Hole For **MAXIMUM** Security

- Huge 12mm Braided Steel Cable

NUT LOCK



TNL740



- A Quick And Easy Solution To Tire Theft. Locks Tire Nut Preventing Wheel Removal
- Fits Side Mount Spare Tires
- Use For Propane Tanks

Part No:

TNL740 Spare Tire Multi-Use Nut Lock. Fits All Side Mount Spare Tires

MULTI-USE SYSTEMS

Made Using TRIMAFLEX™ Ultra Tough Braided Cables

- Great For:
Bikes
Bike Carriers
Watercraft
Trailers
Helmets
Skis/Boots
Snow Boards



T33RC

- Durable 36" Cable Retracts Into 4" Tall Cable Lock

Part No:

T33RC
MAG10SC

Retractable Cable 3-Digit Combo Lock 36" (L) x 3mm

Resettable Combination Cable Combo Lock 10' (L) x 8mm



MAG10SC

- Resettable Combination With 10' x 8mm Braided Cable

- Includes Protective Head Cover

TRIMAX

"Lock It Or Lose It"

CABLE LOCKS

QUADRA-BRAID™ LOCKS

COMBO / KEYED

Vinyl Coated Cable Protects Painted Finish



- Resettable Combination Lock In Coiled & Non-Coiled Cable. No Keys To Lose



- Integrated Keyed Coiled & Non-Coiled Cable Locks With Quick Release Brackets

- Sliding Key Hole Cover Helps Seal Out Dirt
- Includes 3 Keys

- All Cable Locks Include Quick Release Brackets



Coiled

TRC106



Non-Coiled

TRC126

TNRC106

TNRC126



Coiled

TKC106

TKC126



Non-Coiled

TNKC106

TNKC126

Part No:

TRC106 TRIMAFLEX™ Coiled Resettable Combo Lock W/Bracket, 6' (L) x 10mm Dia.

TRC126 TRIMAFLEX™ Coiled Resettable Combo Lock W/Bracket, 6' (L) x 12mm Dia.

TNRC106 TRIMAFLEX™ Non-Coiled Resettable Combo Lock W/Bracket, 6' (L) x 10mm Dia.

TNRC126 TRIMAFLEX™ Non-Coiled Resettable Combo Lock W/Bracket, 6' (L) x 12mm Dia.

TKC106 TRIMAFLEX™ Coiled Keyed Cable Lock W/Bracket, 6' (L) x 10mm Dia.

TKC126 TRIMAFLEX™ Coiled Keyed Cable Lock W/Bracket, 6' (L) x 12mm Dia.

TNKC106 TRIMAFLEX™ Non-Coiled Keyed Cable Lock W/Bracket, 6' (L) x 10mm Dia.

TNKC126 TRIMAFLEX™ Non-Coiled Keyed Cable Lock W/Bracket, 6' (L) x 12mm Dia.

QUADRA-BRAID™ LOCK

LED COMBO

Easy To Use, Day Or Night



TRL126

- Lighted LED Combination Cable Lock



- Includes Quick Release Bracket

Part No:

TRL126 Security LED Combination Lock W/Bracket, 6' (L) X 12mm Dia.

TRIMAX

"Lock It Or Lose It"



CHAINS / CABLES

- BRAIDED CABLES
- CABLE U-LOCKS
- LOCKING ARMORED CABLES
- THEX CHAINS
- U-SHACKLE CABLE LOCK
- ALARMED CABLES/CHAIN



TRIMAX

"Lock It Or Lose It"

BRAIDED CABLES

DUAL LOOP CABLES

Maximum Security
Quadra-Braid
Cables

TRIMAFLEX™



TDL815

TDL1212

TDL1510

TDL3010



Part No:

- TDL815** TRIMAFLEX™ Dual Loop Multi-Use Cable 8' x 15mm
- TDL1212** TRIMAFLEX™ Dual Loop Multi-Use Cable 12' x 12mm
- TDL1510** TRIMAFLEX™ Dual Loop Multi-Use Cable 15' x 10mm
- TDL3010** TRIMAFLEX™ Dual Loop Multi-Use Cable 30' x 10mm

For Maximum Protection
Use With TRIMAX™ MAX60
& MAX40 Disc & U-Locks
For The Ultimate In
Multi-Use Security

CABLE U-LOCKS

For Use On
Motorcycle Discs
& Looped Cables

"Simply The Strongest
Short Shackles
You Can Buy"

HIGH SECURITY

MAX60



MAX40YL

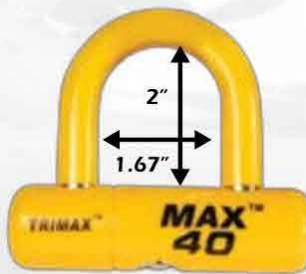

MAX40BK



Part No:

- MAX60** General Purpose U-Lock - Black W/Chrome 14mm Shackles
- MAX40YL** General Purpose U-Lock - Yellow W/Chrome 1/2" Shackles
- MAX40BK** General Purpose U-Lock - Black W/Chrome 1/2" Shackles

TRIMAX™

"Lock It Or Lose It"

BRAIDED CABLES

BRAIDED & COILED

High Security
7 Pin Anti-Drill
Lock Cores

QUADRA-BRAID™ Locks



TQ1532

- 15mm Quadra-Braid Cable x 32" Length



TQ2072

- 20mm Quadra-Braid Cable x 72" Length

- Key Cover Helps Keep Out Dirt & Corrosion



EXCLUSIVE SUPERMAX To HIGH Security Armor Plated Cables Repel Saw Cuts & Bolt Cutters



TQ2548

- Rugged 25mm Quadra-Braid Cable In 48" & 72" Lengths
- HIGH SECURITY Anti-Drill Lock Core



TQ2572

- Key Cover Helps Keep Out Dirt & Corrosion

- TQ Series Locks Come With 3 Ultra Secure Keys. One Key Is A Mini Flashlight



Part No:

TQ1532 TRIMAFLEX™ Integrated Keyed Cable Lock 32" (L) x 15mm

TQ2072 TRIMAFLEX™ Integrated Keyed Cable Lock 72" (L) x 20mm

TQ2548 TRIMAFLEX™ Integrated Keyed Cable Lock 48" (L) x 25mm

TQ2572 TRIMAFLEX™ Integrated Keyed Cable Lock 72" (L) x 25mm

TRIMAX

IRONCLAD™

ARMOR PLATED LOCKS

Maximum Security
Armor Plated
Cable Locks
Covered With
Durable PVC Skin
To Prevent
Scratching

- **Ideal For:**
Bicycles,
Motorcycles,
Spare Tires,
Trailers, Marine
& More



- Ultra Durable Polymer Lock Housing Cover Resists Hammer Strikes & Protects Locking Mechanism
- TG2236SX Includes Quick Release Mounting Bracket



- The IRONCLAD™ Series Locks Come With 3 Ultra Secure Keys. One Key Is A Mini Flashlight



- Patented Sliding Key Cover Resists Grime & Corrosion

Part No:

- TG3072SX** SUPERMAX SECURITY Armor Plated Stainless Steel Locking Cable 72" (L) x 26mm
- TG3048SX** SUPERMAX SECURITY Armor Plated Stainless Steel Locking Cable 48" (L) x 26mm
- TG2236SX** HIGH SECURITY Armor Plated Stainless Steel Locking Cable W/Mounting Bracket 36" (L) x 22mm

TRIMAX

INTEGRATED LOCKS

Case Hardened Triple Heat Treated Chain

- Withstands Over 6 Tons Of Pull Force & 11 Tons Of Cutting Force



- Combined With TFA6 Anchor

KEYED / COMBINATION



THEX™836



THEX™1036



THEX™C103

- Rugged Nylon Locking Housing

- High Strength Combination Chain Lock. No Keys To Break Or Lose

- Anti-Drill & Pick Resistant Lock Mechanism

Part No:

THEXC103 Integrated Combination Lock & Super Chain - 6mm Links x 36" (L)

THEX836 Integrated Lock & Super Chain - 8mm Links x 36" (L)

THEX1036 Integrated Lock & Super Chain - 10mm Links x 36" (L)

SUPER CHAIN SETS



"T-HEX CHAIN LINKS"



- Loop On One End - Can Create A Noose To Use Full Length Of Chain

- Hexagon Shaped Case Hardened Triple Heat Treated Super Chain

- Durable Nylon Sleeve Protects Against Scratches

Part No:

THEX33 THEX Super Chain - 3' 3" (1 Meter) Length W/HEX 12mm Links

THEX50 THEX Super Chain - 5' Length W/HEX 12mm Links

THEX3340 Combo Set - THEX Super Chain - 3' 3" Length x 12mm + MAX40 Disc Lock

THEX5040 Combo Set - THEX Super Chain - 5' Length x 12mm + MAX40 Disc Lock

THEX3360 Combo Set - THEX Super Chain - 3' 3" Length x 12mm + MAX60 Disc Lock

THEX5060 Combo Set - THEX Super Chain - 5' Length x 12mm + MAX60 Disc Lock



**THEX™3360
THEX™5060**



**THEX™33 THEX™3340
THEX™50 THEX™5040**



"Lock It Or Lose It!"

CHAINS / CABLES

U-LOCK & CABLE

The Security Of A Mini U-Lock Combined With The Versatility Of A Cable

MAX-DUAL FORCE



TCU1572

- Max Dual Force Lock System Features Exclusive TRIMAFLEX™ Quadra-Braid Cable For Maximum Theft Prevention

Part No:

TCU1572 Max-Dual Force U-Shackle Lock - 72" (L) x 15mm Dia. TRIMAFLEX™ Cable
TFA6 Wall/Floor Anchor, Includes Mounting Hardware

WALL / FLOOR ANCHOR

- Ideal For Securing Lawn Furniture, Bicycles, Tools, Motorcycles & More
- Use With TRIMAX™ Chains, Cables & Padlocks



TFA6

Mounts Anywhere!



CHAIN / CABLES

Alarmed Locking Mechanism Sets Off Ear Piercing Scream When Moved Or Tampered With

- Push Button Activated Alarm - Use With Alarm Or Cable/Chain Lock Only

25mm Cable



TAL1036
36" Chain

- Chain Withstands Over 6 Tons Of Pull Force & 11 Tons Of Cutting Force

- Features Exclusive TRIMAFLEX™ Quadra-Braid Cables For Maximum Security

TAL2548
48" Cable

TAL2572
72" Cable

- Durable Nylon Sleeve Protects Against Scratches

Part No:

TAL1036 Alarmed Lock & THEX Super Chain - 10mm Links x 36" (L)
TAL2548 Alarmed Lock & Quadra-Braid Cable - 25mm x 48" (L)
TAL2572 Alarmed Lock & Quadra-Braid Cable - 25mm x 72" (L)

TRIMAX

"Lock It Or Lose It"



U-LOCKS

- HIGH SECURITY U-LOCKS
- SHORT U-LOCKS FOR TRIMAX CHAINS & CABLES
- LARGE SHACKLE U-LOCKS FOR BICYCLES & ATBs



TRIMAX

CABLE U-LOCKS

"Simply The Strongest Short Shackle Locks You Can Buy"

- For Use On Motorcycle Discs & Looped Cables

HIGH SECURITY



MAX60
14mm (35/64") Shackle

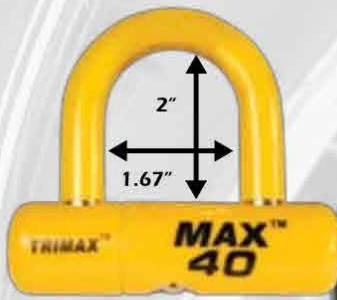

MAX40YL
12.7mm (1/2") Shackle



MAX40BK



- Includes 3 Ultra Secure Keys. One Key Is A Mini Flashlight

Part No:

- MAX60** General Purpose U-Lock - Black W/Chrome 14mm Shackle
- MAX40YL** General Purpose U-Lock - Yellow W/Chrome 1/2" Shackle
- MAX40BK** General Purpose U-Lock - Black W/Chrome 1/2" Shackle

SPECIALTY U-LOCKS

Rubberized Coating Protects Painted Surface

HIGH SECURITY

MAX60X

- 4.1" Extended Shackle (14mm)
- Offers Greater Use For Motorcycle Discs & Looped Cables
- Includes 3 Ultra Secure TRIMAX™ Keys



MAX90

- High Strength Hardened Steel, 16mm Shackle
- Mounting Bracket Included
- Great For Motorcycles, Bikes & ATV's
- Includes 3 Ultra Secure Keys. One Key Is A Mini Flashlight



Part No:

- MAX60X** MINI-U-Shackle Lock, 2.25" x 4.1" Inner Measurement W/ 14mm Shackle
- MAX90** MAX Security U-Shackle Lock, 3.675" x 10.5" Inner Measurement W/16mm Shackle

"Lock It Or Lose It!"

U-LOCKS

14MM SHACKLES

Double Dead Bolt Locking System For Maximum Security

- Includes Quick Release Bicycle Bracket

HIGH SECURITY



MAX802



MAX803



MAX801

- MAX801 Includes 10mm x 48" Dual Loop Cable

- Rotating Key Hole Covers Keep Out Dirt & Corrosion
- Rubberized Coating Protects Painted Surfaces



- Locks Include 2 Keys

15MM SHACKLES

MAXIMUM SECURITY



- Max Security For Motorcycles As Well



MAX701



MAX702

Part No:

- MAX801** MAX Security U-Shackle Lock, 4-1/2" x 7-1/2" W/14mm Shackle, 10mm x 48" Cable
- MAX802** MAX Security U-Shackle Lock, 4-1/2" x 7-1/2" W/14mm Shackle
- MAX803** MAX Security U-Shackle Lock, 4-1/2" x 10-1/2" W/14mm Shackle
- MAX701** MAX Security U-Shackle Lock, 3-1/2" x 5-1/2" W/15mm Shackle
- MAX702** MAX Security U-Shackle Lock, 5" x 9" W/15mm Shackle

TRIMAX

"Lock It Or Lose It"

U-LOCKS

14MM SHACKLES

HIGH SECURITY

High Security Protection For Your Bicycle Or ATB



MAX602
4-1/8" x 8" Shackle

- Includes Quick Release Bicycle Bracket



- Includes 3 Ultra Secure Keys. One Key Is A Mini Flashlight



MAX601
4-1/8" x 11" Shackle

- Heavy Duty Anti-Pick Lock Head
- Key Hole Cover Keeps Out Dirt & Corrosion

Part No:

MAX601

Max-Security Bicycle/ATB U-Shackle Lock, 4-1/8" x 11" W/14mm Shackle

MAX602

Max-Security Bicycle/ATB U-Shackle Lock, 4-1/8" x 8" W/14mm Shackle

"Lock It Or Lose It"



DISC LOCKS

- ROTOR / DISC LOCKS
- ALARMED & NON-ALARMED
- MOTORCYCLE LOCKS



TRIMAX

"Lock It Or Lose It!"

ROTOR/DISC LOCKS

MOTORCYCLE LOCKS

110dB Siren

Ear Piercing Alarm Alerts You Of Any Unwanted Movement Or Possible Lock Tampering

ALARMED



TAL88

- Easy-To-Use Durable Push Button Lock
- Reminder Cable Alerts You To Lock In Use
- 7mm Lock Pin

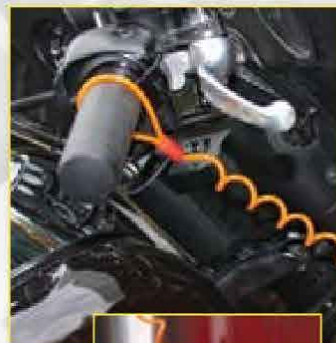

TAL88YL



INCLUDED



TSC612
Reminder Cable



- All Disc Locks Include:
Carrying Pouch, Disc Lock Reminder Cable & 3 Keys

TRIMAX

"Lock It Or Lose It!"

ROTOR/DISC LOCKS

MOTORCYCLE LOCKS

High Security Rotor Locks Help Protect Against Tampering Or Theft!

NON-ALARMED



T665LC
10mm Lock Pin



T665LY
10mm Lock Pin



T645S
5.5mm Lock Pin

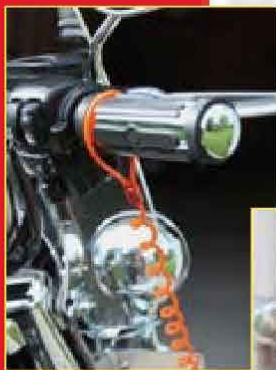

- Rugged Disc Locks Are Hardened To Resist Cutting, Sawing & Chisel Attacks
- Premium Disc Locks Feature High Security Anti-Drill Lock Core
- Locks Include Carrying Pouch, Disc Lock Reminder Cable & 3 Keys. One Key Is A Mini Flashlight

Durable, Easy-To-Use Push Button Lock

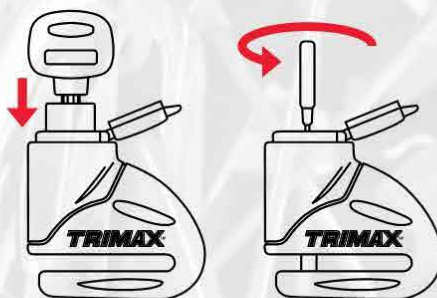

Part No:

- TAL88** Alarmed Disc Lock With 7mm Pin - Chrome W/Pouch & Reminder Cable
- TAL88YL** Alarmed Disc Lock With 7mm Pin - Yellow W/Pouch & Reminder Cable
- T665LC** Hardened Metal Disc Lock With 10mm Pin (Long Throat) - Chrome W/Pouch & Reminder Cable
- T665LY** Hardened Metal Disc Lock With 10mm Pin (Long Throat) - Yellow W/Pouch & Reminder Cable
- T645S** Hardened Metal Disc Lock With 5.5mm Pin (Short Throat) - Yellow W/Pouch & Reminder Cable
- TSC612** Disc Lock Dual Loop Safety Cable (Reminder Cable) 1/8" x 48" (L)

TRIMAX

"Lock It Or Lose It"



PADLOCKS

- INTERNAL SHACKLE LOCK, DOOR HASP
- MAGNUM, COMBINATION & DISC PADLOCKS
- MARINE GRADE, WEATHER PROOF & LAMINATED PADLOCKS



TRIMAX

"Lock It Or Lose It!"

PADLOCKS

MAGNUM / DOOR LOCKS

Protects Against Bolt Cutters

- No Exposed Shackle To Cut Or Saw

SHIELDED



Enlarged Opening Covers & Secures ALL Trailer Hasps!

- Solid Steel & Thicker Body With 3/8" Diameter Internal Shackle
- For Gates, Trucks & Heavy Duty Security Hasps



THPXL
2-7/8" In Diameter



- Available In Single Packs Or Keyed Alike 2 & 3 Packs
- Easy-To-Use & Weather Resistant

TRAILER DOOR HASP

Epoxy Coated Steel 2 Piece Hasp For Trailer & Shed Doors

HIGH SECURITY

THSP2C



Ultimate Hasp Security

- Designed To Work With The THPXL "Hockey Puck"



- The THPXL & THSP2C Combine For The Ultimate In Security



Part No:

- THPXL** "Hockey Puck" Universal Fit Internal Shackle Trailer/Shed Door Lock - Re-Keyable.
- THP2XL** 2-Pack Keyed Alike THPXL
- THP3XL** 3-Pack Keyed Alike THPXL
- THSP2C** "Hockey Puck" Internal Shackle Trailer/Shed Door Hasp - 2 Piece

INDOOR LOCKS

Hardened Chrome Steel



- Commercial Grade & Re-keyable Locks

MAGNUM

TRIMAX, offers a wide selection of high quality premium padlocks for all applications, from school lockers, to severe weather, to high security job sites. Re-keyable and resettable, we have the answer for all your customer's needs.

- Keyed Alike Sets Available



BRASS LOCKS

Resettable

COMBINATION

- Easily Set And Lock In Your Own Combination With Enclosed Key
- Solid Brass Lock Body
- Weather Resistant



DISC LOCK

Protects Against Bolt Cutters

NEW!!
Combination Version



TRP170



- Keyed Alike Sets Available

- Stainless Steel, Exclusive Armor Plated Key Core For Added Security

TRPC170



Resettable

Part No:

- TPL175S** Sq. Hardened 50mm Solid Steel Padlock, 1-1/4" x 10mm Dia. Shackle - Re-Keyable
- TPL275L** Sq. Hardened 50mm Solid Steel Padlock, 2-1/4" x 10mm Dia. Shackle - Re-Keyable
- TPL1251S** Sq. Hardened 64mm Solid Steel Padlock, 1-1/4" x 10mm Dia. Shackle - Re-Keyable
- TPL2251L** Sq. Hardened 64mm Solid Steel Padlock, 2-1/4" x 10mm Dia. Shackle - Re-Keyable
- TPC125** Solid Brass 2" Body W/1-1/4" x 8mm Dia. Hardened Shackle, Resettable
- TPC225** Solid Brass 2" Body W/2-1/4" x 8mm Dia. Hardened Shackle, Resettable
- TRPC170** Stainless Steel 70mm Round Resettable Combination Padlock
- TRP170** Stainless Steel 70mm Round Keyed Padlock
- TRP3170** TRP170 3-Pack, Keyed Alike

MARINE GRADE



▪ TPB87 Available In Keyed Alike 4 Pack, TPB1125

DUAL LOCKING

▪ Solid Brass Body



TPB75



TPB87



TPB1125



TPB1137

WEATHER PROOF

Weather Resistant PVC Housing



TPW1125

▪ Laminated Solid Steel Lock Body
▪ Key Hole Cover Keeps Out Dirt



TPW3125
Keyed Alike 3 Pack

Part No:

Marine Grade Series

- TPB75** 2-Pack Marine Grade Dual Locking Solid Brass Body W/Hardened .75" x 3/16" Dia. Shackle
- TPB87** Marine Grade Dual Locking Solid Brass Body W/Hardened .87" x 1/4" Dia. Shackle
- TPB487** 4-Pack Of Keyed Alike TPB87 Dual Locking Solid Brass Body .87" x 1/4" Dia. Shackle
- TPB1125** Marine Grade Dual Locking Solid Brass Body W/Hardened 1-1/8" x 5/16" Dia. Shackle
- TPB1137** Marine Grade Dual Locking Solid Brass Body W/Hardened 1-3/8" x 3/8" Dia. Shackle

Weather Proof Series

- TPW1125** Weather Proof Laminated Solid Steel Body, Dual Locking 1-1/8" x 5/16" Dia. Shackle
- TPW3125** 3-Pack Of Keyed Alike TPW1125 Weather Proof Locks - 1-1/8" x 5/16" Dia. Shackle

LAMINATED



▪ TLM100 Available In Keyed Alike 4 Pack, TLM4100



TLM87



TLM100



TLM1125



TLM2150

Part No:

- TLM87** Dual Locking 30mm Solid Steel Laminated Padlock W/7/8" X 3/16" Dia. Shackle
- TLM100** Dual Locking 40mm Solid Steel Laminated Padlock W/1" X 1/4" Dia. Shackle
- TLM4100** 4-Pack Keyed Alike TLM100 40mm Padlocks W/1" X 1/4" Dia. Shackle
- TLM1125** Dual Locking 50mm Solid Steel Laminated Padlock W/1-1/8" X 5/16" Dia. Shackle
- TLM2150** Dual Locking 65mm Solid Steel Laminated Padlock W/1-1/2" X 7/16" Dia. Shackle

"Lock It Or Lose It"™



SPECIALTY LOCKS

- LUNETTE TOW RING LOCK,
5TH WHEEL LOCK,
WHEEL DISC LOCK
- UNIVERSAL WHEEL
CHOCK LOCKS
- OUTBOARD MOTOR LOCK,
GUN LOCKS



TRIMAX

"Lock It Or Lose It!"

SPECIALTY LOCKS

WHEEL LOCK

Clamps Tight To Wheel For Added Security

NEW!! Super MAX 400

- Heavy Gauge Steel Disc Covers Lug Nuts To Prevent Tire Removal
- Fits Almost All 10 - 18" Wheels



- Includes 2 Rugged Keys

Part No:

TWL100

- **Maximum Security For:** Trucks, Construction Equipment, Trailers, Boats, Cars, ATV's & 4x4's

Adjustable Wheel Lock. Fits Nearly All 10 - 18" Wheels.

TWL400

Adjustable Wheel Lock. Fits Nearly All 10 - 18" Wheels. Includes Weather Proof Padlock.

LUNETTE LOCK

MAX Security For Unattended Pintle Hook Trailers

PINTLE HOOK

TLR51

Lunette Tow Ring Security Lock



- Made From Heavy Duty Weather Resistant Metal Alloy
- Fits 2-7/8" Inside Diameter
- Easy To Install
- Includes 2 Rugged Keys



Part No:

TLR51

Lunette Tow Ring Lock, 2-7/8" Inside Dia.

5TH WHEEL LOCK

MAX Security For Unattended 5th Wheel Trailers

TFW55



- Constructed Of Heavy Gauge Alloy For Added Security
- Rugged Weather Proof Epoxy Powder Coat Finish Prevents Rust



Easy To Install

- Unlock TFW55, Lock Head Will Spring Out From The Lock. Slide Lock Up To Cover Hitch. Push In Lock Head & Turn Key

Part No:

TFW55

5th Wheel Trailer Lock

- Includes 2 Rugged Keys

TRIMAX

"Lock It Or Lose It!"

SPECIALTY LOCKS

CHOCK LOCKS

"Chock It & Lock It"™

ULTRA-MAX SECURITY



TCL65



TCL75



- Exclusive Dual Action Design - Chocks & Locks The Wheel To Prevent Trailer Roll Away

- Available In Two Sizes:
TCL65 - 6" - 10.5"
TCL75 - 7" - 11.25"
- Made Of Heavy Gauge Rugged Powder Coated Steel
- Includes 3 Keys
- Rubber Coated Arms Protect Wheel Finish

- High Strength Pick Resistant Locking Mechanism With Cover To Help Keep Out Dirt & Grime

2-PACKS



- Available In Keyed Alike 2-Packs Includes Carrying Case

- Quick & Easy Installation For Unattended: Trailers, Construction Equipment, Cars, Boats, ATV's & More!



Application Guide

Tire Size	TCL75	TCL65
16.5x6.5-8	X	
4.8"-R12	X	X
7.5"-R16	X	
195/75/R14	X	X
205/60/R15	X	X
205/70/R15	X	X
215/70/R15	X	X
225/75/R15	X	X (snug fit)
235/75/R15	X	X
235/80/R16	X	
33"x12.5"/R15	X	

Part No:

- TCL65** Deluxe Universal Wheel Chock Lock. Closed 6", Open 10.5", Reach 7.25"
- TCL75** Deluxe Universal Wheel Chock Lock. Closed 7", Open 11.25", Reach 10.5"
- TCL265** Deluxe TCL65 Universal Wheel Chock Lock 2-Pack
- TCL275** Deluxe TCL75 Universal Wheel Chock Lock 2-Pack

TRIMAX

MOTOR LOCK

Fits Most Outboard Motors

- Water Proof Powder Coat Finish

TBL610



- Constructed Of Heavy Gauge Steel For Maximum Security

Part No:

TBL610 Outdoor Motor Lock, Quick Release/Install, Clamps & Secures For Maximum Security

BOW RING LOCK

5-1/2" Span Fits ALL Bow Rings



T6

WATERCRAFT

- Added Security For Your Personal Watercraft

- High Quality Forged Chrome Plated Machine Hardened Steel
- Test Specifications Exceed 32,000 LBS.

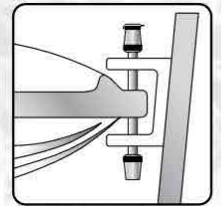

Part No:

T6 Watercraft Locking Pin, 5-1/2" X 1/2" Dia.

GUN LOCKS

For Total Peace Of Mind

- Installs & Removes In Seconds

- TGL22 Available In Single & Keyed Alike Triple Packs

TGCL44 Available In Single & Double Packs

KEYED & COMBO

- 3 Digit Combination Lock Is Easy To Apply & Remove

TGCL44



- Rubber Lining Helps Protect Gun's Finish



TGL22

Part No:

- TGCL44 Max-Security Combo Gun Lock, Single Pack
- TGCL244 Max-Security Combo Gun Lock, Double Pack
- TGL22 Max-Security Keyed Gun Lock, Single Pack
- TGL322 Max-Security Keyed Alike Gun Locks, Triple Pack

TRIMAX

"Lock It Or Lose It"



BIKE CARRIERS



- DELUXE 3 & 4 BIKE HITCH MOUNT CARRIERS
- 2 & 4 BIKE TRAY STYLE CARRIERS
- UNIVERSAL 3 BIKE TRUNK MOUNT CARRIER



TRIMAX

"Lock It Or Lose It!"

BIKE CARRIERS

RAZORBACK 4X

PREMIUM
4 Bike Carrier



▪ Tilted Position For Rear Access



RAZORBACK 3

DELUXE
3 Bike Carrier

HITCH MOUNT

- Soft Padded Cradles And Rubber Straps Help Position And Secure The Bikes
 - Arms Can Easily Fold When Not In Use
 - Rack And Bikes Tilt Down For Gate Access Using Easily Accessible Release
 - Strong Easy To Use Locking Attachment System To Fit Any 1-1/4" And 2" Receiver
 - Solid Steel Frame Carries Up To 4 Bikes (Max 15kg/33lbs Per Bike)



▪ Integrated Locking Cable

Safety Straps Included

RMRB4X

HITCH MOUNT

- Soft Padded Cradles And Rubber Straps Help Position And Secure The Bikes
- Arms Can Easily Fold When Not In Use
- Complete Rack Tilts Down For Gate Access
- Strong Easy To Use Locking Attachment System To Fit Any 1-1/4" And 2" Receiver
- Solid Steel Frame Carries Up To 3 Bikes (Max 15kg/33lbs Per Bike)



RMRB3

Safety Straps Included



Part No:

RMRB4X Razorback 4X – PREMIUM 4-Bike Receiver Hitch Mounted Carrier

RMRB3 Razorback 3 – DELUXE 3-Bike Receiver Hitch Mounted Carrier

TRIMAX

BLADE-RUNNER 4

DELUXE
4 Bike Carrier



▪ Folded Storage Position

TRAY STYLE

- Compact And Light Weight Design Allows User To Easily Store Product In The Car Trunk
- Adjustable Padded Arms To Support The Bikes Vertically
- Strong, Easy To Use Locking Attachment System To Fit Any 2" Receiver
- High Resistance Wheel Straps With Zamack Buckles And Soft Pads Fit Rims And Tire Sizes
- Wheel Supports Adjust To Fit Most Bike Sizes
- Arm Can Fold When Gate In Use For Gate Access
- Solid Steel Frame Carries Up To 4 Bikes (Max 15kg/33lbs Per Bike)



Safety Straps Included

RMBR4

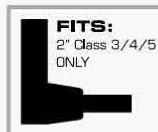

FITS:
2" Class 3/4/5 ONLY



BLADE-RUNNER 2

DELUXE
2 Bike Carrier

TRAY STYLE

Same Features As 4 Bike

- Solid Steel Frame Carries Up To 2 Bikes (Max 15kg/33lbs Per Bike)



Safety Straps Included

RMBR2

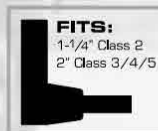

FITS:
1-1/4" Class 2
2" Class 3/4/5

Part No:

RMBR2 Blade-Runner 2 – DELUXE 2-Bike Tray Style Receiver Hitch Mounted Carrier

RMBR4 Blade-Runner 4 – DELUXE 4-Bike Tray Style Receiver Hitch Mounted Carrier



EASY RIDER

**UNIVERSAL
3 Bike Carrier**



- Attaches To Cars, SUV's & Vans

TRUNK MOUNT

- Soft Padded Cradles And Rubber Straps Securely Position The Bikes
- Adjustment With Easy To Use Cam Lever Mechanism
- Coated Hooks To Protect The Vehicles Paint
- 6 Straps For Higher Stability
- The Complete Rack Folds And Can Be Easily Stored Inside The Car



- Easy To Use Cam Lever

Part No:

RMER3 Easy Rider – PREMIUM 3-Bike Trunk Mounted Carrier



**100% Assembled
Safety Straps Included**



**BICYCLE
LOCKS**

**Keep Your Bicycles
Secured And Safe**

ACCESSORIES

Multi-Use
CABLE LOCKS



**Quadra-Braid Cable
DUAL LOOP**



Versa-Cable
VMAX6
Page 25

MAG10SC
Page 26



Moveable,
Cinchable
Lock Head

High Security
CABLE U-LOCKS



MAX60X
Page 35



MAX602
Page 37



MAX801
Page 36



MAX802
Page 36



TKC126
Page 27

TKC126
Page 27



TKL126
Page 27



MAX60
Page 35



MAX40YL
Page 35



MAX40BK
Page 35



MAX90
Page 35



"Lock It Or Lose It"



- PLANOGRAMS
- 4 X 4
- 4 X 8
- END CAPS



PROMOTIONAL

- NATIONAL TRADE SHOWS
- ASSORTED LOCK DISPLAYS
- CABLE POP DISPLAYS
- HITCH DISPLAYS
- ACCESSORIES
- BANNERS
- SHIRTS
- HATS



POP DISPLAYS

Convenient, Attractive, Sturdy & Mobile

- Includes Header Card & Hooks
- **TDR40 & TDR40M** (Marine) Entry Level Display
- **TDR100** Expanded - Deluxe Display

PROVEN SUCCESS

Get With The Program

It's A Proven Success!

Specialty Truck Dealers, R.V. Dealers, Hitch Installers, Marine Stores, Auto Dealers, All Across North America Have Taken Advantage Of The TRIMAX™ Merchandising Program And Substantially Increased Their Lock Sales.

- **Flexible Assortment Mix**
Allows You To Tailor The Planogram To Fit Your Customer's Demographics & Requirements.
- **Sell More Premium Product**
Increase Margin Dollars, Inventory Turns, And Most Of All... Customer Satisfaction Keeps Them Coming Back!

Create Your Own 2-Sided Assortment To Fit Your Clientele!

Team With



Part No:

- TDR40**
- TDR40M**
- TDR100**

Point of Purchase Display, Header Card & Hooks
 Point of Purchase Stainless Marine Display, Header Card & Hooks
 Expanded Deluxe Point of Purchase Display, Header Card & Hooks



TRIMAX™

"Lock It Or Lose It"

PRODUCT DISPLAY

POP DISPLAYS

Convenient & Attractive Unit To Display The New RAZOR Adjustable Hitches

ADJUSTABLE HITCHES



Strength/Function/Style

- Increase Sales Of High End Products
- Portable Display Can Be Easily Located Anywhere In Your Store For Better Customer Contact

RZRDR

Part No:

RZRDR TRIMAX Razor Display Rack, Displays 3 Razor Hitches & Comes With 25 Hooks



ACCESSORIES

- Contact TRIMAX For Promotional Products Available



TRIMAX

"Lock It Or Lose It"™



Strength / Function / Style™



NEW!
2.5" Aluminum
MAX-HD Hitch

2" Aluminum
XTR Hitch



2018/2019

Learn more about boat parts and hardware on our website.