

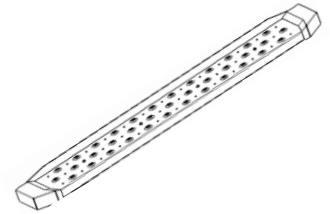

Running Board

Part No. RBW12B



**Fits: 2015-Current FORD F150,
2017-Current Superduty Super Cab**



60-180 min

Cutting is not
Required

Drilling is not
Required



REMOVE CONTENTS FROM BOX. VERIFY ALL PARTS ARE PRESENT.



READ INSTRUCTIONS CAREFULLY BEFORE STARTING INSTALLATION.

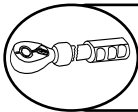

DO NOT OVER TORQUE. STANDARD OPERATING LOAD FOR TIGHTEN
BODY MOUNT NUTS & BOLTS VARIES FROM **45** TO **65** FOOT POUND.

PARTS LIST:

Qty	Part Description	Qty	Part Description
2	Steel Running Boards	12	8mm x 24mm x 2mm Washer
4	Mounting Brackets (left or right)	12	8-1.25mm Nylon Lock Nut
4	6mm Double Bolt Plates	8	6mm x 22mm x 2mm Flat Washers
12	8mm Plastic Retainers	8	6mm Lock Washers
		8	6mm Hex Nuts

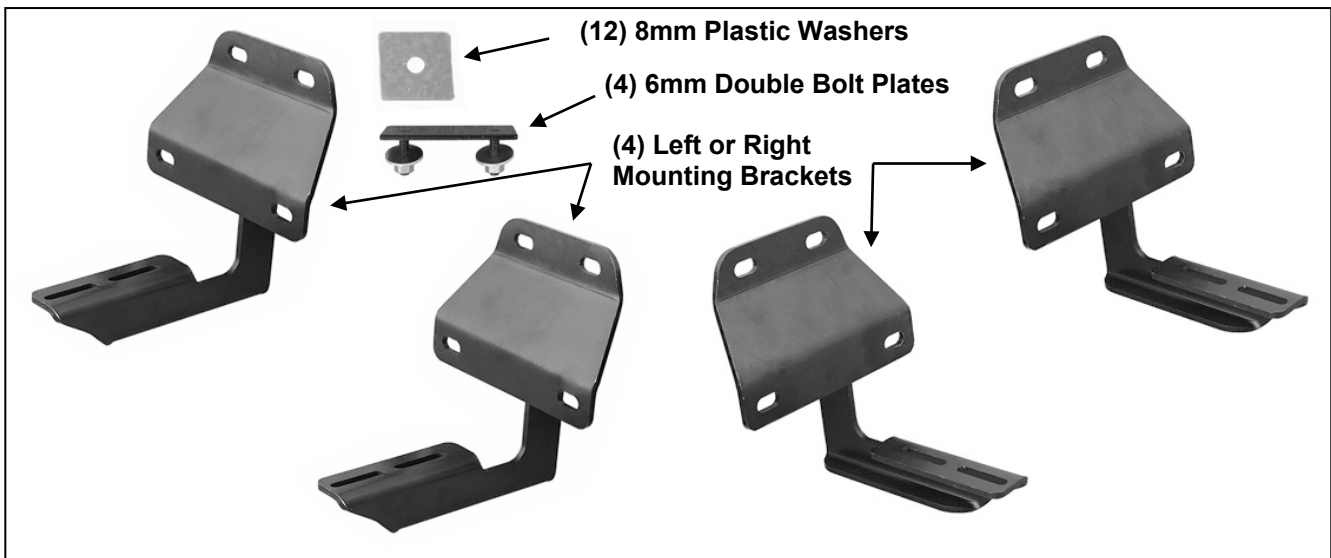

PROCEDURE:

REMOVE CONTENTS FROM BOX. VERIFY ALL PARTS ARE PRESENT. READ INSTRUCTIONS CAREFULLY BEFORE STARTING INSTALLATION. ASSISTANCE IS RECOMMENDED.

1. Start the installation under the passenger side of the vehicle. Locate the front factory running board mounting location along the inner side of the body, **(Figure 1)**.
2. Slide (1) Plastic Washer over each of the (3) factory mounting studs in the body panel, **(Figures 2 & 3)**. **IMPORTANT:** The Plastic Washers are designed to prevent corrosion between the aluminum body panel and the steel mounting brackets. **Do not install the Brackets without the Plastic Washers.**
3. Select (1) Mounting Bracket. **NOTE:** All (4) Brackets are universal and will fit left or right side. Attach the Mounting Bracket to the (3) factory studs with (3) 8mm Flat Washers and (3) 8mm Nylon Lock Nuts, **(Figures 4 & 5)**. Leave brackets loose at this time.

4. Repeat **Steps 1—3** to install the remaining rear passenger side Bracket, (**Figure 8**).
5. Carefully unwrap and select (1) Running Board. Place the Running Board on top of the Brackets. Locate the channels in the bottom of the Running Board. Select (2) 6mm Double Bolt Plates, (**Figure 6**). Insert the Bolt Plates into the channels in the bottom of the Running Board closest to the Brackets, (**Figure 7**). Lift the Running Board up and guide the studs through the Brackets.
6. Attach the Running Board to the Brackets with (4) 6mm Flat Washers, (4) 6mm Lock Washers and (4) 6mm Hex Nuts, (**Figure 8**). **NOTE:** The Running Board is designed to fit close to the vehicle. It may be necessary to loosen the Bracket hardware slightly and tilt the Brackets downward to insert the Running Board between the Brackets and the body.
7. Level and adjust the Running Board as necessary and fully tighten all hardware.
8. Repeat **Steps 1—7** for the driver side Running Board installation.
9. Do periodic inspections to the installation to make sure that all hardware is secure and tight.

Passenger/right Side Installation Pictured

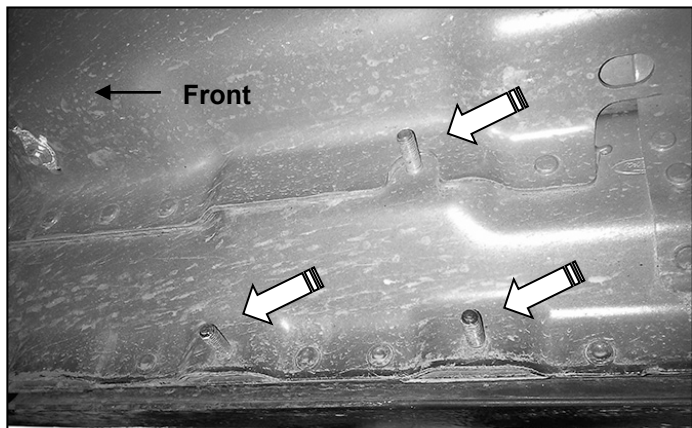

(Fig 1) Passenger side front mounting location

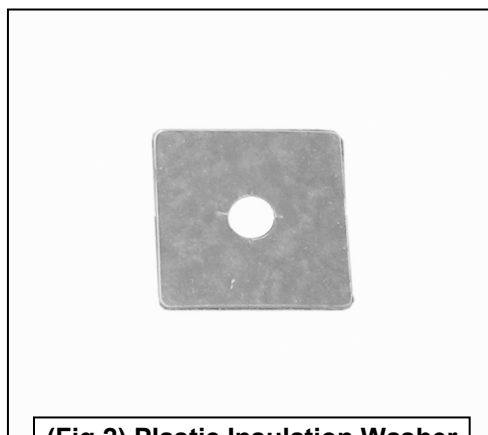

(Fig 2) Plastic Insulation Washer

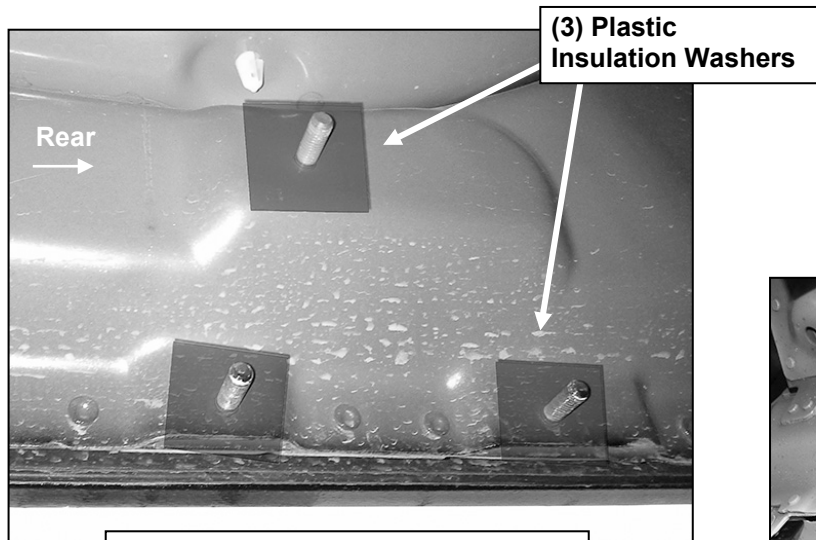

(Fig 3) Thread Plastic Washers onto all mounting studs. Passenger side rear mounting location pictured

- (3) 8mm Plastic Washers**
- (3) 8mm Flat Washers**
- (3) 8mm Nylon Lock Nuts**

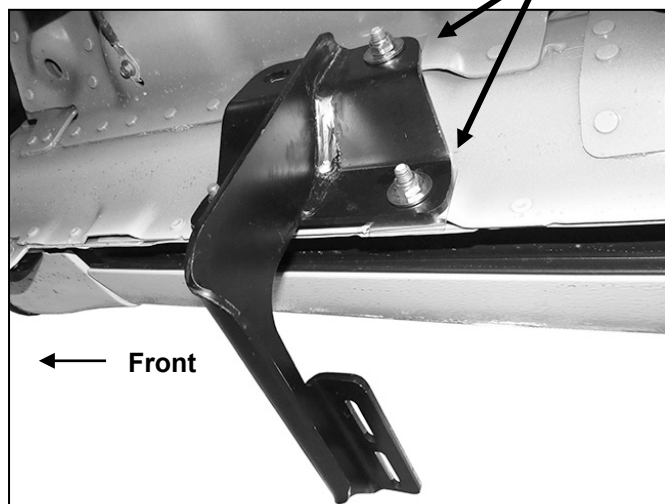

(Fig 4) passenger side front Bracket installation

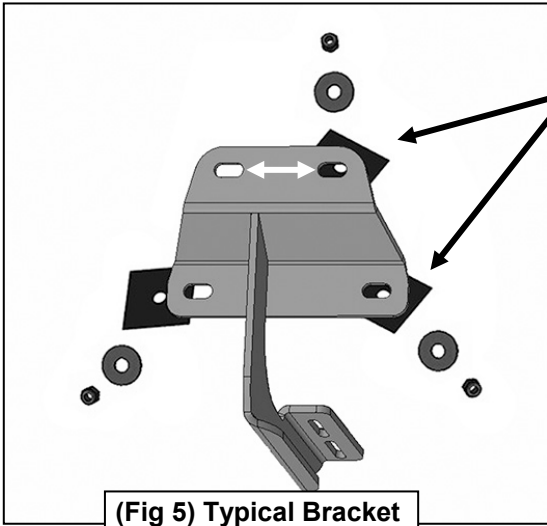

- (3) 8mm Plastic Washers
- (3) 8mm Flat Washers
- (3) 8mm Nylon Lock Nuts

(Fig 5) Typical Bracket installation illustrated



(Fig 6) 6mm Double Bolt Plate

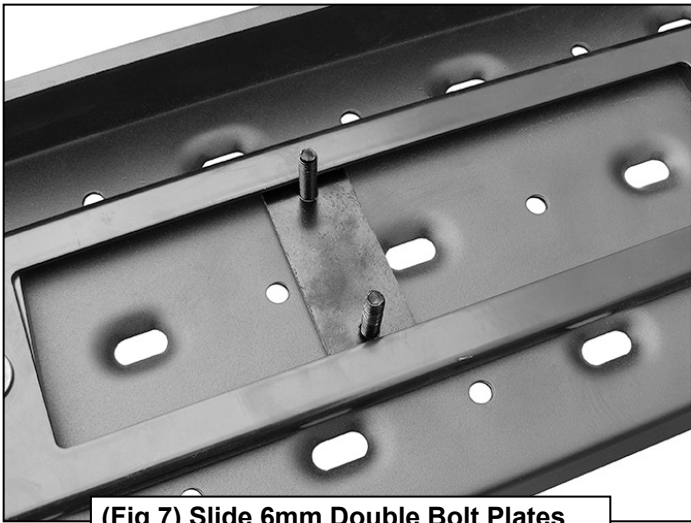

(Fig 7) Slide 6mm Double Bolt Plates into track on bottom of Running Board

- 6mm Double Bolt Plate
- (2) 6mm Flat Washers
- (2) 6mm Lock Washers
- (2) 6mm Hex Nuts

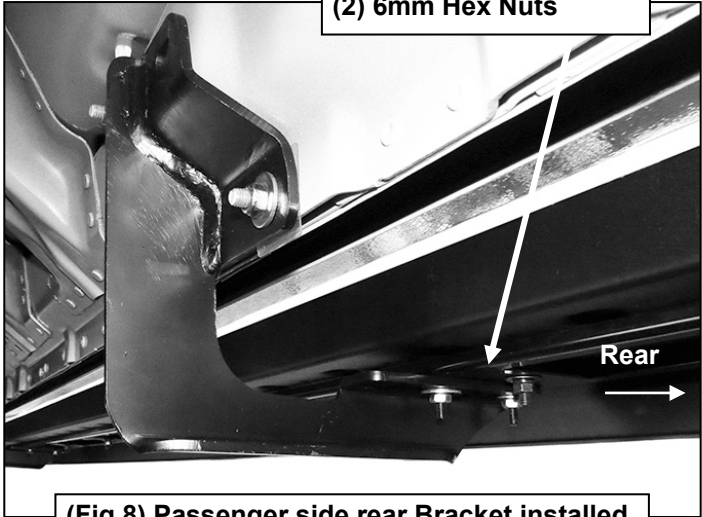

(Fig 8) Passenger side rear Bracket installed



Complete Installation

No.	Parts Identification
1	Passenger / Right 'Rear' Bracket marked "PR"
2	Driver / Left 'Rear' Bracket marked "DR"
3	Passenger / Right 'Center' Bracket marked "PC"
4	Driver / Left 'Center' Bracket marked "DC"
5	Passenger / Right 'Front' Bracket marked "PF"
6	Driver / Left 'Front' Bracket marked "DF"

Note:

- This guide is to identify the parts and not a reference for part count.
- For part count, refer Parts List.
- Product / Bracket image is representative and actual design may vary.

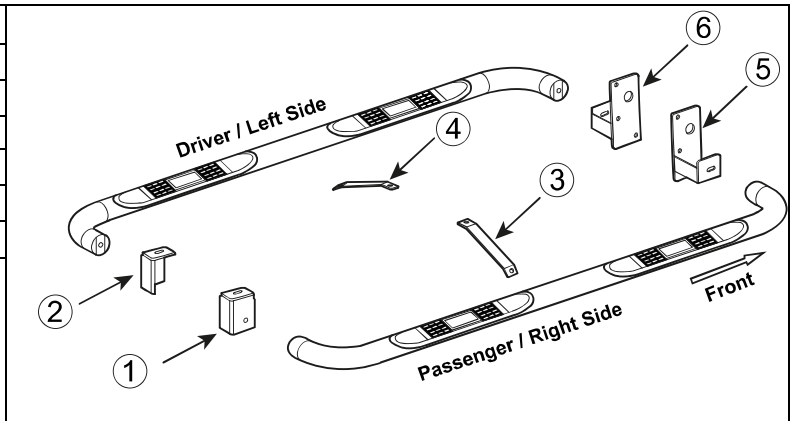

PRODUCT CARE

- Periodically check the product to ensure all fasteners are tight and components are intact.
- Regular waxing is recommended to protect the finish of the product.
- **Use ONLY Non-Abrasive automotive wax.** Use of any soap, polish or wax that contains an abrasive is detrimental and can scratch the finish leading to corrosion.
- Aluminum polish may be used to polish small scratches and scuffs for **Stainless Steel finish.**
- Mild soap may be used to clean the product for both **Stainless Steel and Black finish.**

FAQ's

1. Hardware's are not of correct size.

In GMC / Chevrolet truck model 2006 & up, customer needs to reuse the factory body bolts to install the bracket. If your vehicle is not GMC / Chevrolet 2006 & up, ensure that holes are not partially covered with any plastic grommet or rust? If it is, remove the plastic grommet & rust from the thread holes & re-try the installation.

2. Mounting Bracket are not getting Installed properly.

In some cases Illustration images shown in Installation manual may not be the exactly same as per actual vehicle images ,also if Driver / Passenger side mounting brackets are very identical in the design, suggest referring Parts Identification guide to avoid fitment issue.

3. Products are thumping / rattling after installation.

Ensure that all required mounting brackets / hardware's are installed & tighten correctly. Suggest using white lithium / regular grease between the metal to metal contact surfaces.

4. Side Bar is not aligning with vehicle / Step Pads are not aligning with vehicle doors.

Side bar may be interchanged or mounting brackets are not installed at the correct position in the vehicle. Refer Parts identification guide.

5. Missing / Excess Hardware.

Recheck hardware count as per the part list.

6. Product not installing properly.

Ensure make model year, cab length and bed size of your vehicle is listed in the application. All installation steps are followed correctly.

Check out these other TrailFX Products!!



BULL BAR



GRILLE GUARDS



BED RAILS



RUNNING BOARDS

Keystone Automotive Operations Inc. (KAO) warrants this product to be free of defects in material and workmanship at the time of purchase by the original retail consumer. KAO disclaims any other warranties, express or implied, including the warranty of fitness for a particular purpose or an intended use. If the product is found to be defective, KAO may replace or repair the product at our option, when the product is returned prepaid, with proof of purchase. Alteration to, improper installation, or misuse of this product voids the warranty. KAO's liability is limited to repair or replacement of products found to be defective, and specifically excludes liability for any incidental or consequential loss or damage.