

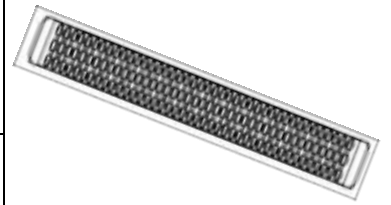

Aggressive Running Board

Part No. RBA015TI



Fits: 1999-2016

Ford F250/350/450/550 Super Duty Crew Cab



ASSISTANCE IS RECOMMENDED.



60-180 min

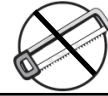

Cutting Not Required



Drilling Not Required



REMOVE CONTENTS FROM BOX. VERIFY ALL PARTS ARE PRESENT.



READ INSTRUCTIONS CAREFULLY BEFORE STARTING INSTALLATION.

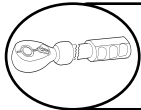

DO NOT OVER TORQUE. STANDARD OPERATING LOAD FOR TIGHTEN BODY MOUNT NUTS & BOLTS VARIES FROM 45 TO 65 FOOT POUND.

PARTS LIST:

Qty	Part Description	Qty	Part Description
2	Aggressive Running Boards	18	8mm Lock Washers
6	Universal Mounting Brackets (left of right)	12	8-1.25mm Hex Nuts
6	8-1.25mm Clip-Nuts	6	8-1.25mm Nylon Lock Nuts
12	8-1.25mm x 25mm Hex Bolts	6	8mm Double Bolt Plates
30	8mm x 24mm x 2mm Flat Washer		

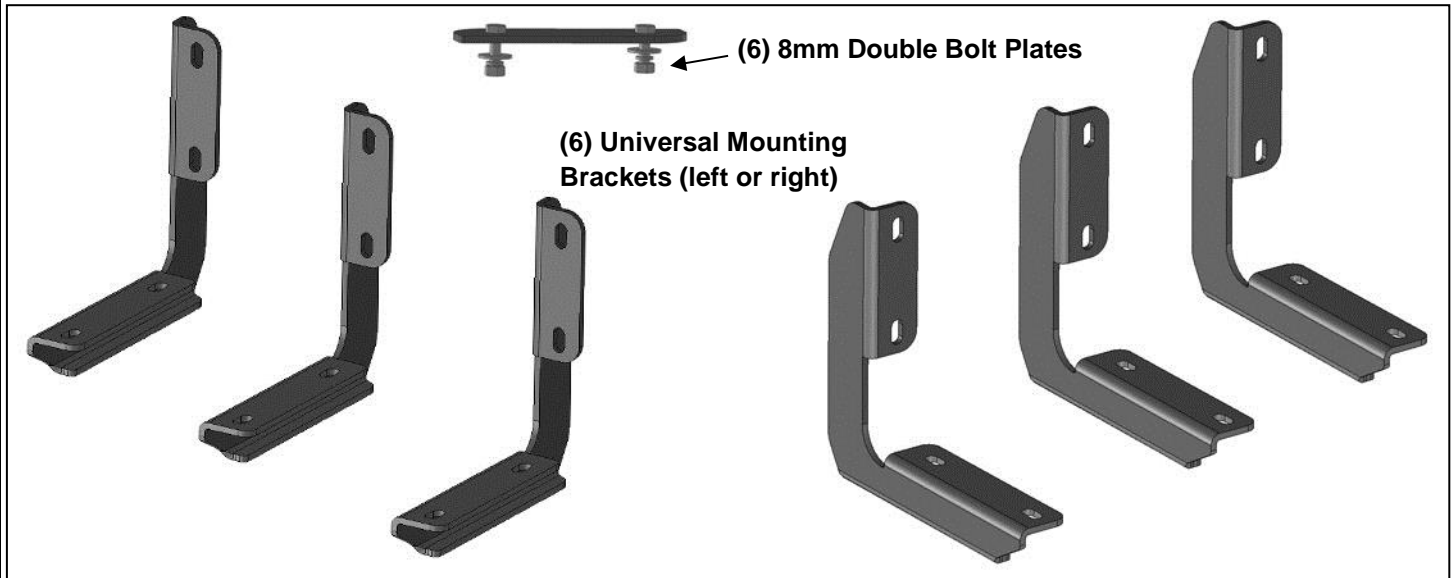

INSTALLATION PROCEDURE:

1. Starting on the front-driver side of the vehicle, locate the (2) holes through the bottom of the body panel, (pinch weld). Next locate the rectangular opening and small hole in the inner body panel directly above the holes in the pinch weld, **(Figures 1 & 2)**. **NOTE:** The holes in the inner panel may be covered with sealing tape or insulation, remove as required.

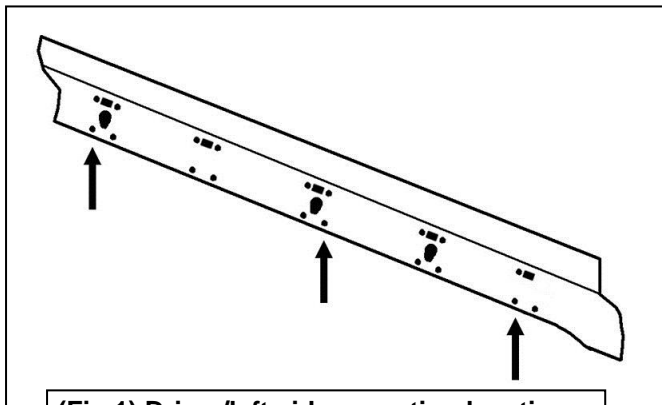

(Fig 1) Driver/left side mounting locations

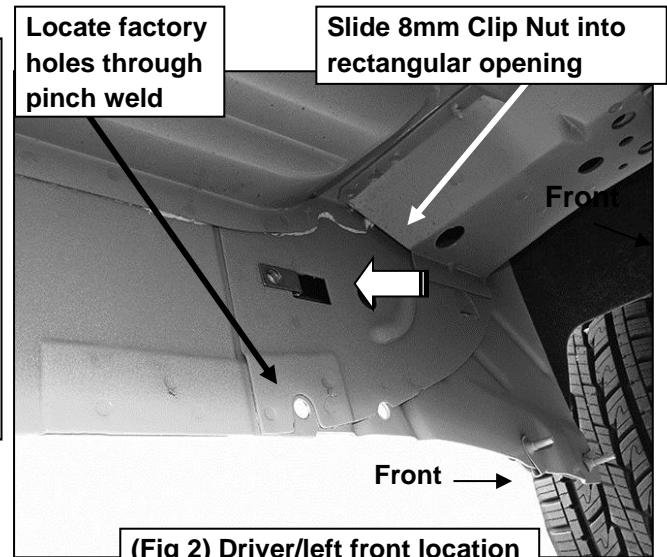

Locate factory holes through pinch weld

Slide 8mm Clip Nut into rectangular opening

(Fig 2) Driver/left front location

2. Slide (1) 8mm Clip Nut into the rectangular opening with the nut towards the inside. Line up the threaded nut on the clip with the round hole toward the rear, **(Figure 2)**.
3. Select (1) Mounting Bracket. Attach the top of the Bracket to the Clip Nut with (1) 8mm Hex Bolt, (1) 8mm Lock Washer and (1) 8mm Flat Washer, **(Figure 3)**. Leave loose at this time. Line up the lower hole in the Bracket with the hole through the pinch weld. Attach the Bracket to the pinch weld with (1) 8mm Hex Bolt, (2) 8mm Flat Washers and (1) 8mm Nylon Lock Nut, **(Figure 3)**. Snug but do not fully tighten Bracket hardware.

8mm x 25mm Hex Bolt
(2) 8mm Flat Washers
8mm Nylon Lock Nut

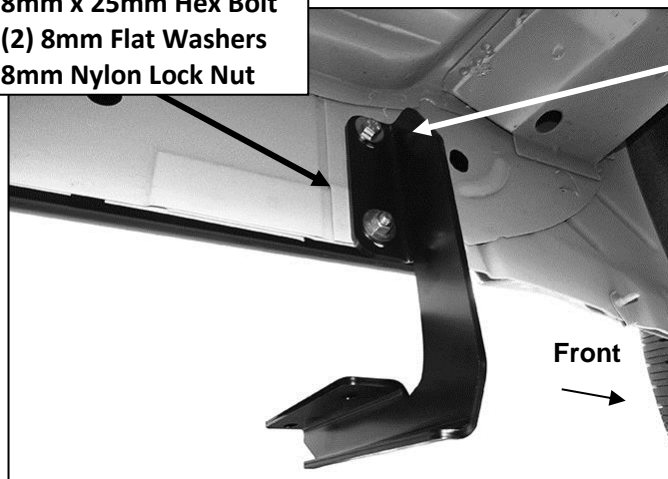

8mm x 25mm Hex Bolt
8mm Lock Washer
8mm Flat Washer

(Fig 3) Driver/left front mounting Bracket pictured

4. Move toward the center of the vehicle. Use **Figure 1** to determine the correct mounting location for the center Bracket. Select (1) 8mm Clip Nut. Repeat **Steps 2 & 3** to install (1) Clip Nut in the correct top mounting hole, **(Figure 4)**. Repeat **Step 4** to attach the Bracket to the Clip Nut and pinch weld, **(Figure 5)**. Snug but do not fully tighten Bracket hardware.

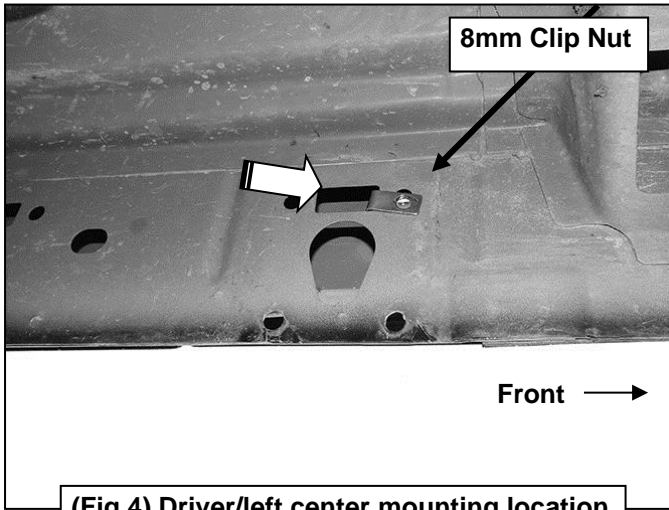

(Fig 4) Driver/left center mounting location

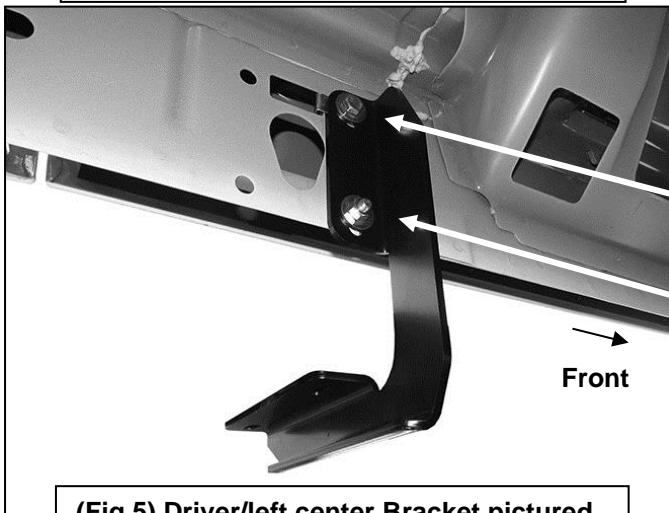

8mm x 25mm Hex Bolt
8mm Lock Washer
8mm Flat Washer

8mm x 25mm Hex Bolt
(2) 8mm Flat Washers
8mm Nylon Lock Nut

(Fig 5) Driver/left center Bracket pictured

5. Continue along the cab to the rear mounting location. Locate the last (2) mounting holes in the pinch weld towards the back of the cab, (Figures 1 & 6). Use Figure 1 to determine correct mounting location. Repeat Step 5 to install (1) Bracket in the rear location, (Figures 6 & 7).

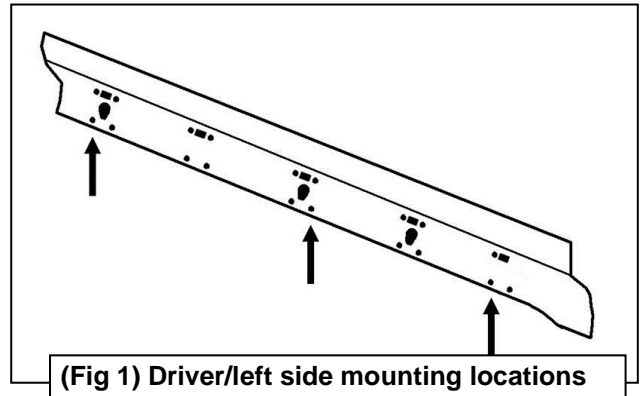

(Fig 1) Driver/left side mounting locations

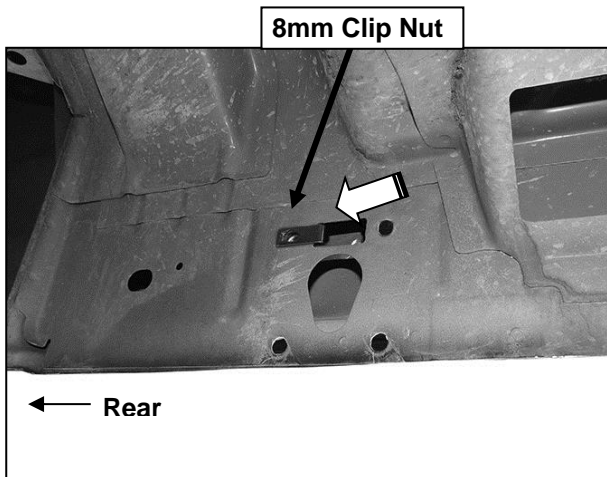

(Fig 6) Driver/left rear Mounting Bracket location



(Fig 7) Driver/left rear Mounting Bracket installed

- Carefully unwrap (1) Running Board. Place the Running Board on top of the Brackets. Locate the channels in the bottom of the Running Board. Select (3) 8mm Double Bolt Plates, **(Figure 8)**. Insert the Bolt Plates into the channels in the bottom of the Running Board closest to the Brackets, **(Figure 9)**. Lift the Running Board up and guide the studs down through the Brackets.



(Fig 8) 8mm Double Bolt Plate

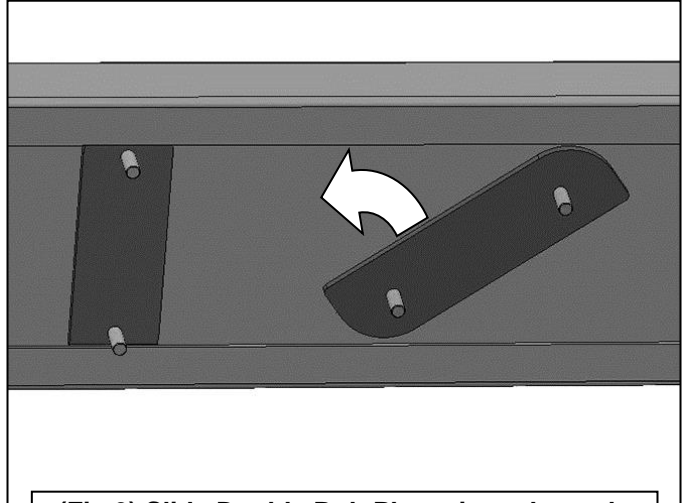

(Fig 9) Slide Double Bolt Plates into channels

- Attach the Running Board to the (3) Mounting Brackets with the included (6) 8mm Flat Washers, (6) 8mm Lock Washers and (6) 8mm Hex Nuts, **(Figures 10 & 11)**. Do not tighten hardware at this time.

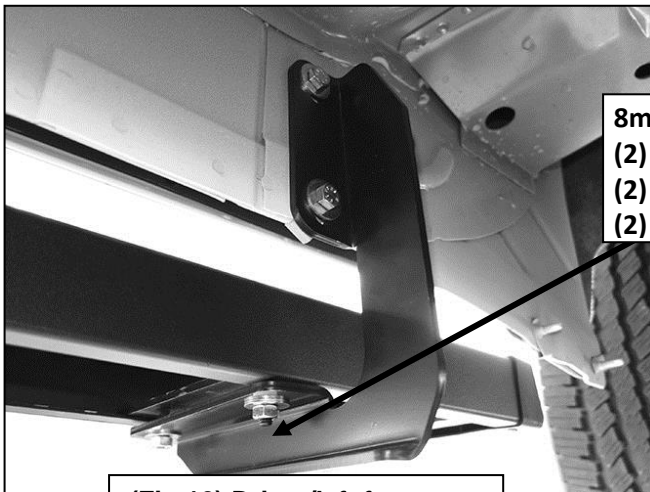

(Fig 10) Driver/left front mounting Bracket installed

**8mm Double Bolt Plate
(2) 8mm Flat Washers
(2) 8mm Lock Washers
(2) 8mm Hex Nuts**



(Fig 11) Driver/left center Mounting Bracket installed

- Level and adjust the Running Board front to rear as desired. Note typical installation is with front of Running Board 2" back from front wheel opening or mud flap if equipped. Once adjusted, fully tighten all hardware.
- Repeat **Steps 1—9** for the passenger side Running Board installation.
- Do periodic inspections to the installation to make sure that all hardware is secure and tight.



Complete Installation

PARTS IDENTIFICATION GUIDE

Driver Side tube packed using "Green" color foam sheet. Passenger Side tube packed using "White" color foam sheet

No.	Parts Identification
1	Passenger / Right 'Rear' Bracket marked "PR"
2	Driver / Left 'Rear' Bracket marked "DR"
3	Passenger / Right 'Center' Bracket marked "PC"
4	Driver / Left 'Center' Bracket marked "DC"
5	Passenger / Right 'Front' Bracket marked "PF"
6	Driver / Left 'Front' Bracket marked "DF"

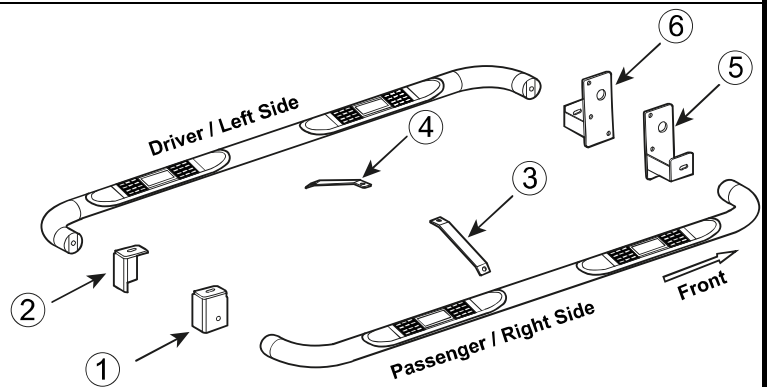

Note:

- > This guide is to identify the parts and not a reference for part count.
- > For part count, refer Parts List.
- > Product / Bracket image is representative and actual design may vary.

PRODUCT CARE

- Periodically check the product to ensure all fasteners are tight and components are intact.
- Regular waxing is recommended to protect the finish of the product.
- **Use ONLY Non-Abrasive automotive wax.** Use of any soap, polish or wax that contains an abrasive is detrimental and can scratch the finish leading to corrosion.
- Aluminum polish may be used to polish small scratches and scuffs for **Stainless Steel finish.**
- Mild soap may be used to clean the product for both **Stainless Steel and Black finish.**

FAQ's

1. Hardware's are not of correct size.

In GMC / Chevrolet truck model 2006 & up, customer needs to reuse the factory body bolts to install the bracket. If your vehicle is not GMC / Chevrolet 2006 & up, ensure that holes are not partially covered with any plastic grommet or rust? If it is, remove the plastic grommet & rust from the thread holes & re-try the installation.

2. Mounting Bracket are not getting Installed properly.

In some cases Illustration images shown in Installation manual may not be the exactly same as per actual vehicle images ,also if Driver / Passenger side mounting brackets are very identical in the design, suggest referring Parts Identification guide to avoid fitment issue.

3. Products are thumping / rattling after installation.

Ensure that all required mounting brackets / hardware's are installed & tighten correctly. Suggest using white lithium / regular grease between the metal to metal contact surfaces.

4. Side Bar is not aligning with vehicle / Step Pads are not aligning with vehicle doors.

Side bar may be interchanged or mounting brackets are not installed at the correct position in the vehicle. Refer Parts identification guide.

5. Missing / Excess Hardware.

Recheck hardware count as per the part list.

6. Product not installing properly.

Ensure make model year, cab length and bed size of your vehicle is listed in the application. All installation steps are followed correctly.

Check out these other TrailFX Products!!



Keystone Automotive Operations Inc. (KAO) warrants this product to be free of defects in material and workmanship at the time of purchase by the original retail consumer. KAO disclaims any other warranties, express or implied, including the warranty of fitness for a particular purpose or an intended use. If the product is found to be defective, KAO may replace or repair the product at our option, when the product is returned prepaid, with proof of purchase. Alteration to, improper installation, or misuse of this product voids the warranty. KAO's liability is limited to repair or replacement of products found to be defective, and specifically excludes liability for any incidental or consequential loss or damage.