

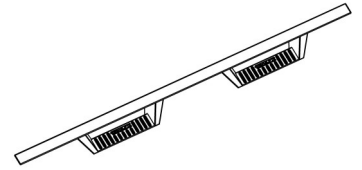

TrailFX Drop Down Step

Part No. DHS012B

Product image



Fits: Jeep Wrangler JK 4DR 2007-2018



TO AVOID BEING SCRATCHED, PLEASE PROTECT THE SURFACE OF THE TAILGATE VENT COVER CAREFULLY.



REMOVE CONTENTS FROM BOX. VERIFY ALL PARTS ARE PRESENT.



READ INSTRUCTIONS CAREFULLY BEFORE STARTING INSTALLATION.



ALIGN THE STEP BARS AS DESIRED AND TIGHTEN ALL M10 FASTENERS TO 30 ft. - lbs., AND THE M8 FASTENERS TO 15 ft.-lbs, AND THE M6 FASTNERS TO 7 ft -lbs..



60 min



Cutting Not Required



Drilling Not Required

PARTS LIST:

Item	Qty	Part Description	Tools Needed
1	1	Step Bar Driver Side	10 MM SOCKET & WRENCH
2	1	Step Bar Passenger Side	13 MM SOCKET & WRENCH
3	1	Front Driver Side Mounting Bracket	14 MM SOCKET & WRENCH
4	1	Front Passenger Side Mounting Bracket	15 MM SOCKET & WRENCH
5	1	Center Driver Side Mounting Bracket	ALLEN KEY SET
6	1	Center Passenger Side Mounting Bracket	RATCHET
7	1	Rear Driver Side Mounting Bracket	TORQUE WRENCH
8	1	Rear Passenger Side Mounting Bracket	
9	12	M8 Bolt	
10	12	M8 Lock Washer	
11	6	M8 Hex Nut	
12	18	M8 Flat Washer	
13	6	M8 U Nut Clip	
14	12	M6 Button Head Bolt (Black Stainless Steel)	
15	12	M6 Flat Washer (Black Stainless Steel)	
16	12	M6 Flat Washer	
17	12	M6 Lock Washer	
18	12	M6 Hex Nut	
19	12	M10 Flange Bolt	
20	12	M10 Flange Nut	
21	3	Driver Side Support Bracket	
22	3	Passenger Side Support Bracket	

INSTALLATION PROCEDURE

Mounting Kit Images

Item 3

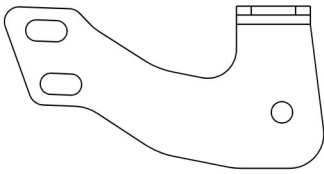

Item 5

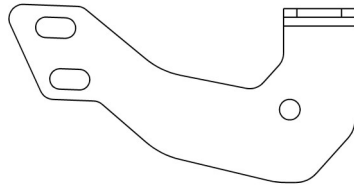

Item 7

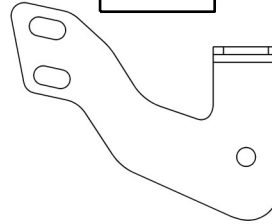

Item 21

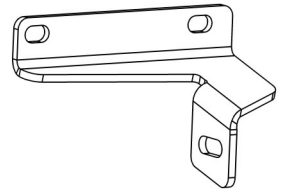

Item 4

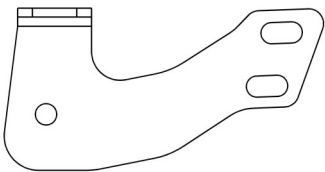

Item 6

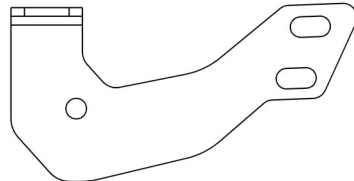

Item 8

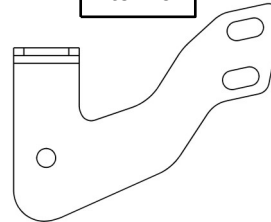

Item 22

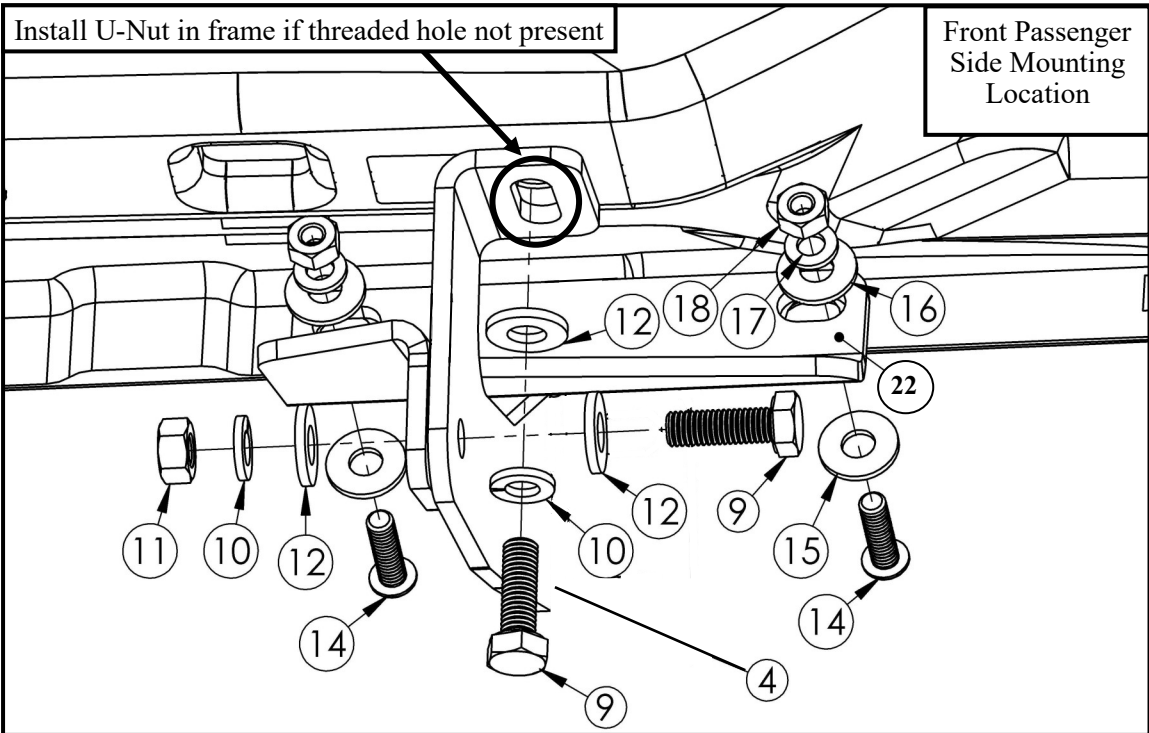
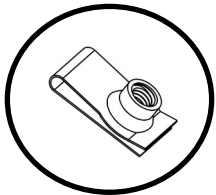
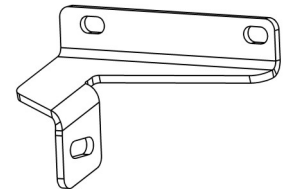

1. Start at the front passenger side of vehicle and grab Front Passenger Side Mount Bracket and the Passenger Side Support Bracket. Loosely Mount the brackets to the rocker panel using the supplied M8 and M6 hardware. See **Figure 1**.
2. Center and Rear location mount similarly.
3. Repeat for driver side of the vehicle.

INSTALLATION PROCEDURE

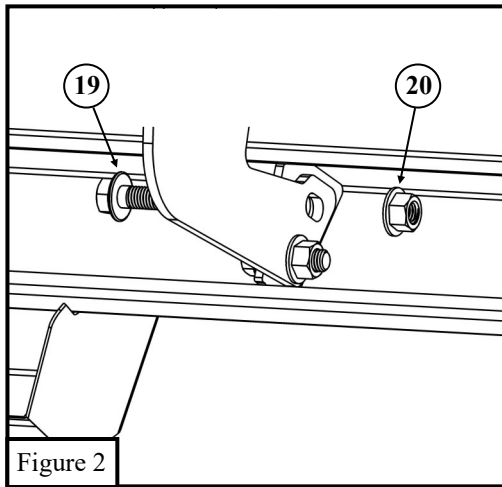

4. Grab Passenger Side Bar and install loosely to mount brackets with (6) M10 Flange bolts and (6) Serrated Flange Nuts. See **Figure 2**.
5. Repeat for driver side.
6. Align and adjust the step bars as needed and tighten all hardware.

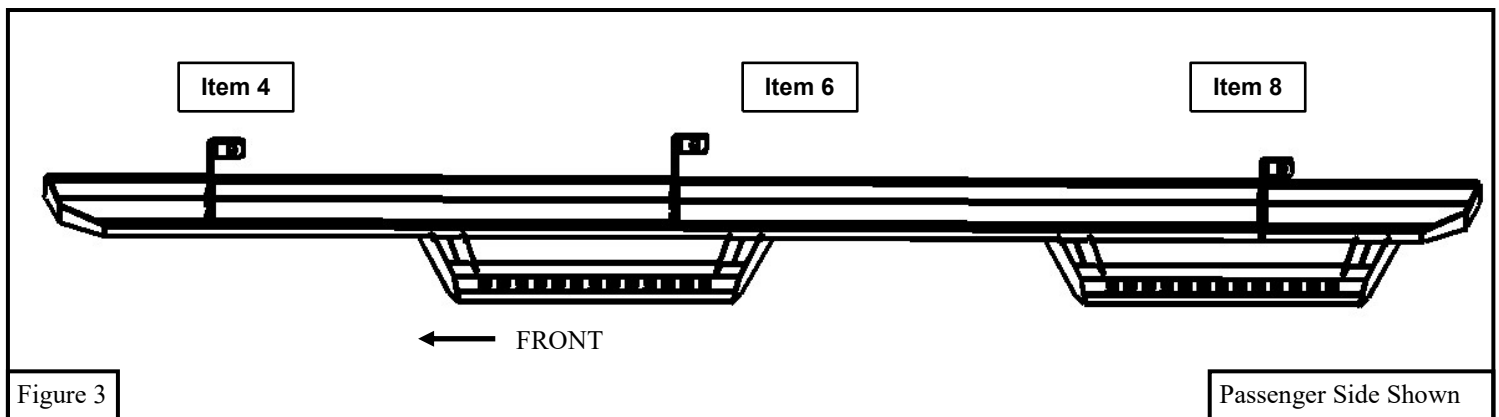

COMPLETE INSTALLATION



PRODUCT CARE

1. Periodically check the product to ensure all fasteners are tight and components are intact.
2. Mild soap may be used to clean the product.

FAQ's

1. **Mounting bracket are not getting Installed properly.**
In some cases Illustration images shown in Installation manual may not be the exactly same as per actual vehicle images ,also if Driver / Passenger side mounting brackets are very identical in the design, suggest referring Parts Identification guide to avoid fitment issue.
2. **Products are thumping / rattling after installation.**
Please ensure that all required mounting brackets / hardware's are installed & tighten correctly. Suggest using white lithium / regular grease between the metal to metal contact surfaces.
3. **Missing / Excess Hardware.**
Recheck hardware count as per the part list.
4. **Product not installing properly.**
Ensure make model year, cab length and bed size of your vehicle is listed in the application. All installation steps are followed correctly.

Check out these other TrailFX Products!!

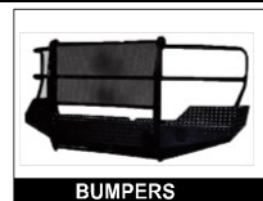

Keystone Automotive Operations Inc. (KAO) warrants this product to be free of defects in material and workmanship at the time of purchase by the original retail consumer. KAO disclaims any other warranties, express or implied, including the warranty of fitness for a particular purpose or an intended use. If the product is found to be defective, KAO may replace or repair the product at our option, when the product is returned prepaid, with proof of purchase. Alteration to, improper installation, or misuse of this product voids the warranty. KAO's liability is limited to repair or replacement of products found to be defective, and specifically excludes liability for any incidental or consequential loss or damage.