

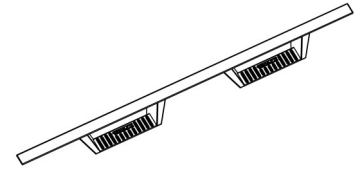

# TrailFX Drop Down Step

## Part No. DHS008B / DHS009B

Product image



Fits: Ford F-250 / 350 / 450 / 550 Super Cab & Super Crew  
1999-2016



TO AVOID BEING SCRATCHED, PLEASE PROTECT THE SURFACE OF THE TAILGATE VENT COVER CAREFULLY.



REMOVE CONTENTS FROM BOX. VERIFY ALL PARTS ARE PRESENT.



READ INSTRUCTIONS CAREFULLY BEFORE STARTING INSTALLATION.



ALIGN THE STEP BARS AS DESIRED AND TIGHTEN ALL M10 FASTENERS TO 30 ft. - lbs., AND THE M8 FASTENERS TO 15 ft.-lbs.



60 min



Cutting Not Required



Drilling Not Required

### PARTS LIST:

Item	Qty	Part Description	Tools Needed
1	1	Step Bar Driver Side	13 MM SOCKET & WRENCH
2	1	Step Bar Passenger Side	14 MM SOCKET & WRENCH
3	6	Mounting Bracket	15 MM SOCKET & WRENCH
4	3	Driver Side Spacer Bracket	RATCHET
5	3	Passenger Side Spacer Bracket	TORQUE WRENCH
6	10	M8 U Nut Clip	
7	10	M8 Bolt	
8	22	M8 Lock Washer	
9	22	M8 Flat Washer	
10	12	M8 Hex Nut	
11	12	M8 Button Head Bolt (Black Stainless)	
12	12	M8 Flat Washer (Black Stainless)	
13	12	M10 Flange Bolt	
14	12	M10 Flange Nut	

### Mounting Kit Images

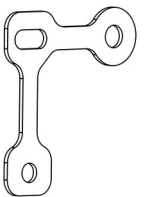
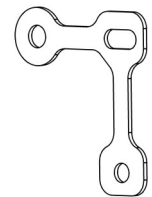
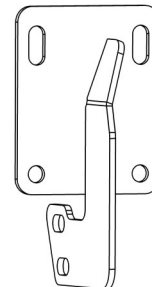
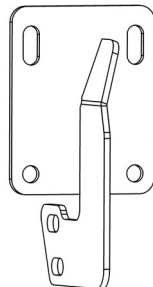
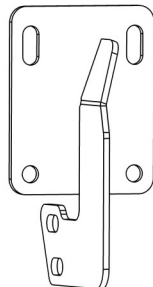
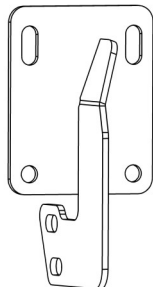
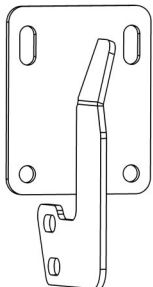
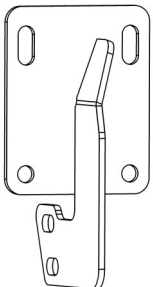

Item 3

Item 4

Item 5

## INSTALLATION PROCEDURE

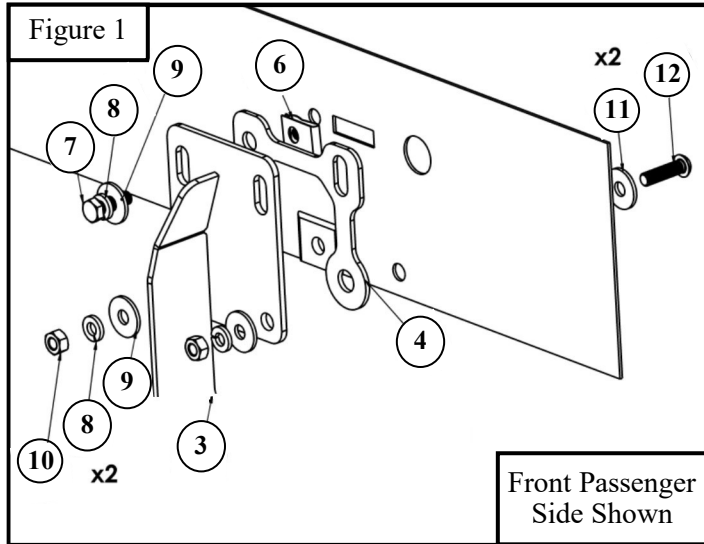
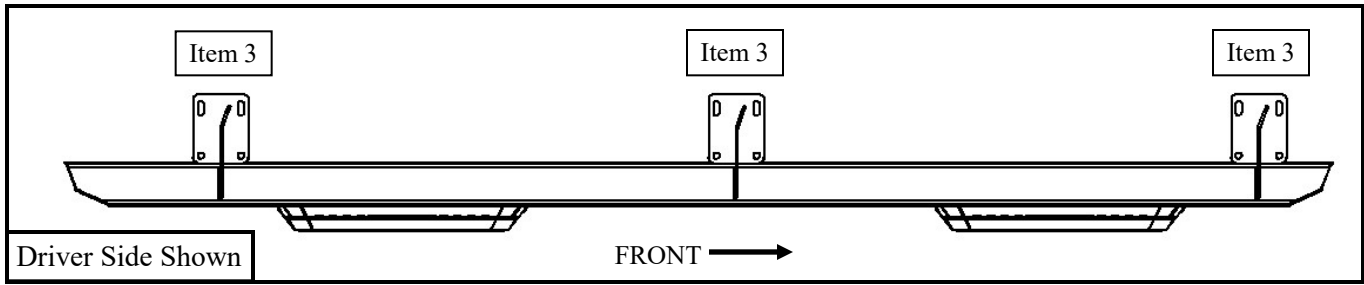

1. Start at the front passenger side of vehicle and grab a Mount Bracket. Use supplied M8 hardware to loosely mount the front mount bracket to the rocker panel. See **Figure 1**.

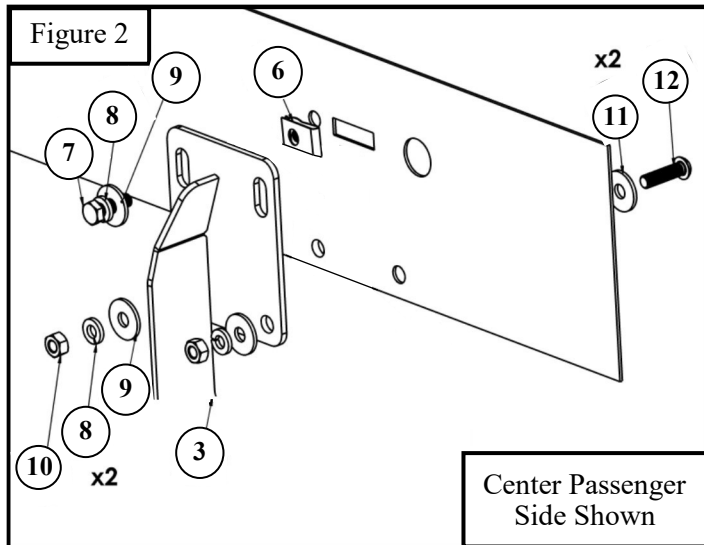

2. Repeat for center and rear locations. See **Figure 2**.
3. Repeat for driver side.

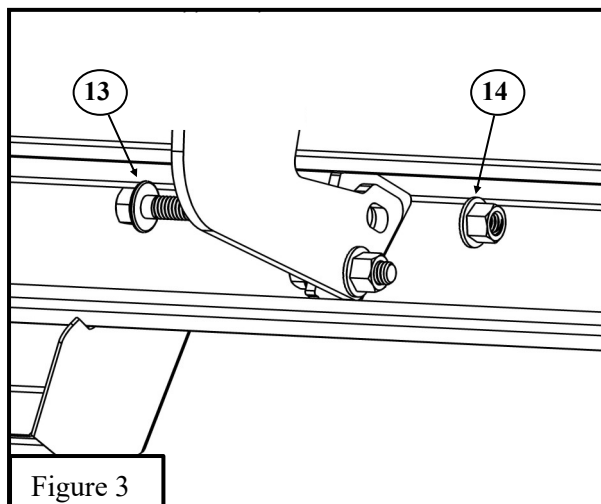

4. Grab Passenger Side Bar and loosely install to mount brackets with (6) M10 Flange bolts and (6) Serrated Flange Nuts. See **Figure 3**.
5. Repeat for driver side.
6. Align and adjust the step bars as needed and tighten all hardware.

COMPLETE INSTALLATION



### **PRODUCT CARE**

1. Periodically check the product to ensure all fasteners are tight and components are intact.
2. Mild soap may be used to clean the product.

### **FAQ's**

1. **Mounting bracket are not getting Installed properly.**  
*In some cases Illustration images shown in Installation manual may not be the exactly same as per actual vehicle images ,also if Driver / Passenger side mounting brackets are very identical in the design, suggest referring Parts Identification guide to avoid fitment issue.*
2. **Products are thumping / rattling after installation.**  
*Please ensure that all required mounting brackets / hardware's are installed & tighten correctly. Suggest using white lithium / regular grease between the metal to metal contact surfaces.*
3. **Missing / Excess Hardware.**  
*Recheck hardware count as per the part list.*
4. **Product not installing properly.**  
*Ensure make model year, cab length and bed size of your vehicle is listed in the application. All installation steps are followed correctly.*

### **Check out these other TrailFX Products!!**

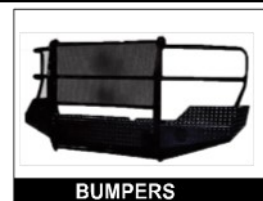

*Keystone Automotive Operations Inc. (KAO) warrants this product to be free of defects in material and workmanship at the time of purchase by the original retail consumer. KAO disclaims any other warranties, express or implied, including the warranty of fitness for a particular purpose or an intended use. If the product is found to be defective, KAO may replace or repair the product at our option, when the product is returned prepaid, with proof of purchase. Alteration to, improper installation, or misuse of this product voids the warranty. KAO's liability is limited to repair or replacement of products found to be defective, and specifically excludes liability for any incidental or consequential loss or damage.*