



# Bed Rail

## Part No. D0001S/B



Fits: 2014 - CURRENT Chevrolet Silverado/GMC Sierra 1500 With 6.5' Standard Bed  
2015 - CURRENT Chevrolet Silverado/GMC Sierra 2500/3500 With 6.5' Standard Bed



60-180 min

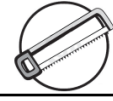

Cutting May be Required



Drilling Not Required



REMOVE CONTENTS FROM BOX. VERIFY ALL PARTS ARE PRESENT.



READ INSTRUCTIONS CAREFULLY BEFORE STARTING INSTALLATION.

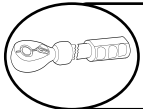

DO NOT OVER TORQUE. STANDARD OPERATING LOAD FOR TIGHTEN BODY MOUNT NUTS & BOLTS VARIES FROM 45 TO 65 FOOT POUND.

### PARTS LIST:

Qty	Part Description	Qty	Part Description
1	Driver/Left Bed Rail	2	10mm x 25mm Hex Bolts
1	Passenger/Right Bed Rail	2	10mm Lock Washers
2	80mm Rectangular Threaded Brackets	2	10mm x 34mm x 3mm Flat Washers
2	50mm Parallelogram Threaded Bracket	4	10mm x 20mm OD x 1.5mm Small S/Steel Flat Washers
2	10mm Double Nut Plates	1	Allen Wrench
4	10-1.50mm x 50mm Allen Head Bolts		

### INSTALLATION PROCEDURE

#### ASSISTANCE IS RECOMMENDED.

1. VERIFY BEDRAIL IS CORRECT LENGTH TO COVER BOTH STAKE POCKETS BEFORE CUTTING BEDSIDE COVERS!
2. Start installation at the passenger side rear stake pocket, **(Figure 1)**. Select (1) 10mm Double Nut Bracket, **(Figure 2A)**. Remove the rubber plug in the side of the stake pocket. Insert the Bracket into the large rear stake pocket. Bolt the lower end of the Bracket to the hole in the side of the stake pocket with (1) 10mm Hex Bolt, (1) 10mm Lock Washer and (1) 10mm x 34mm Large Flat Washer, **(Figure 2B)**. Snug but do not fully tighten hardware at this time.

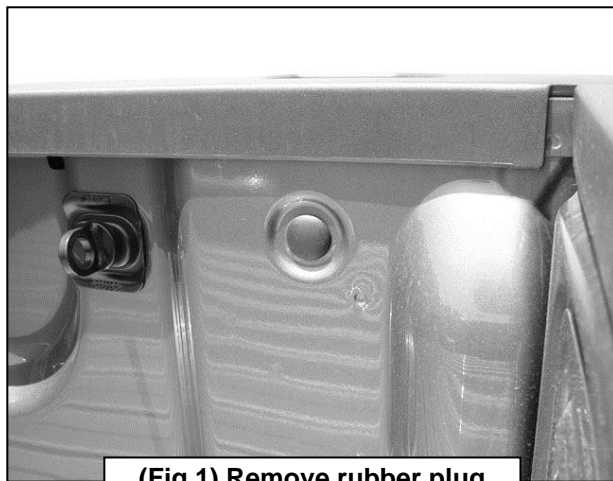

**(Fig 1) Remove rubber plug from side of rear stake pocket**



**Fig 2A**

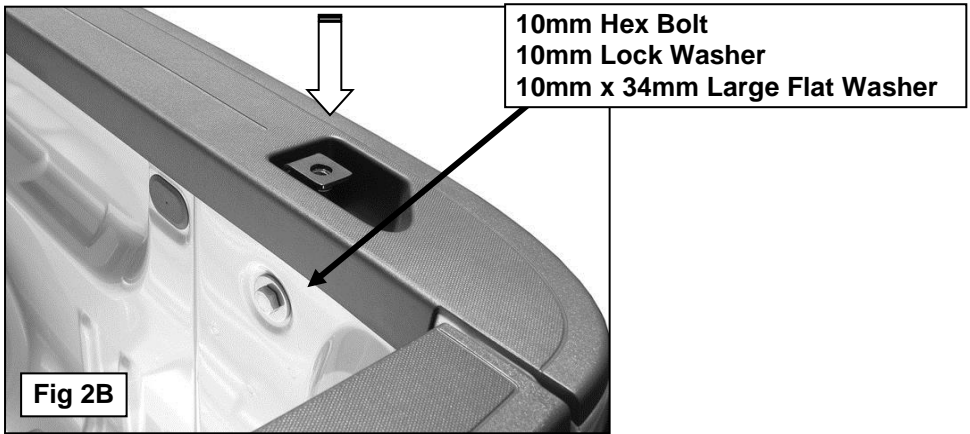

3. Move to the front stake pocket. Carefully cut along the factory lines molded into the plastic cover, **(Figure 3)**. **IMPORTANT:** The factory lines may not represent the correct location or size of the stake pocket and may be larger than the actual stake pocket opening. **Be very careful** cutting through the plastic cover to avoid damage to the top of the bed.

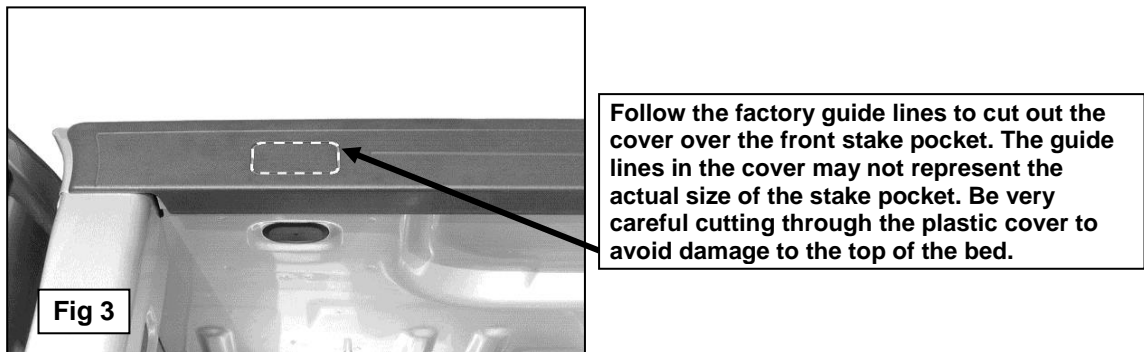

4. Select the passenger/right side Bed Rail. Insert (1) 10mm Button Head Allen Bolt with (1) 10mm Small Flat Washer through the front mounting plate and into (1) Threaded Plate as illustrated in **Figure 4**. **NOTE:** Two types of Threaded Plates are included in the kit, **(Figures 6A & 6B)**. Use the largest Plate possible to fit across the inside of the stake pocket. Leave hardware loose at this time.
5. With the hardware loose in the front mounting plate, carefully position the Bed Rail onto the top of the bed. Tilt the Bolt and/or Bedrail side to side to slide the Threaded Plate into and under the lip on both sides of the steel part of the stake pocket, **(Figure 5)**. Use the largest Plate possible to fit across the inside of the stake pocket, **(Figures 6A & 6B)**. Snug but do not tighten hardware at this time.
6. Move to the rear location. Line up the hole in the mounting plate on the Bed Rail with the 10mm Nut Plate Bracket inside the stake pocket, **(see Step 2, Fig. 2B)**. Secure the Bed Rail to the Bracket with (1) 10mm Button Head Allen Bolt with (1) 10mm Small Flat Washer, **(Figure 7)**. Do not tighten hardware at this time.
7. Line up the front and rear of the Bed Rail with the top of the bed and tighten all hardware. To tighten the front mounting position, pull up on the Bed Rail to hold the Threaded Plate in place and centered across the pocket. Keep pulling up on the Bed Rail to prevent the Plate from moving/rotating while tightening the 10mm mounting bolt, **(Figure 6A & 6B)**.
8. Repeat **Steps 2 – 7** for driver side Bed Rail installation.
9. Do periodic inspections to the installation to make sure that all hardware is secure and tight.

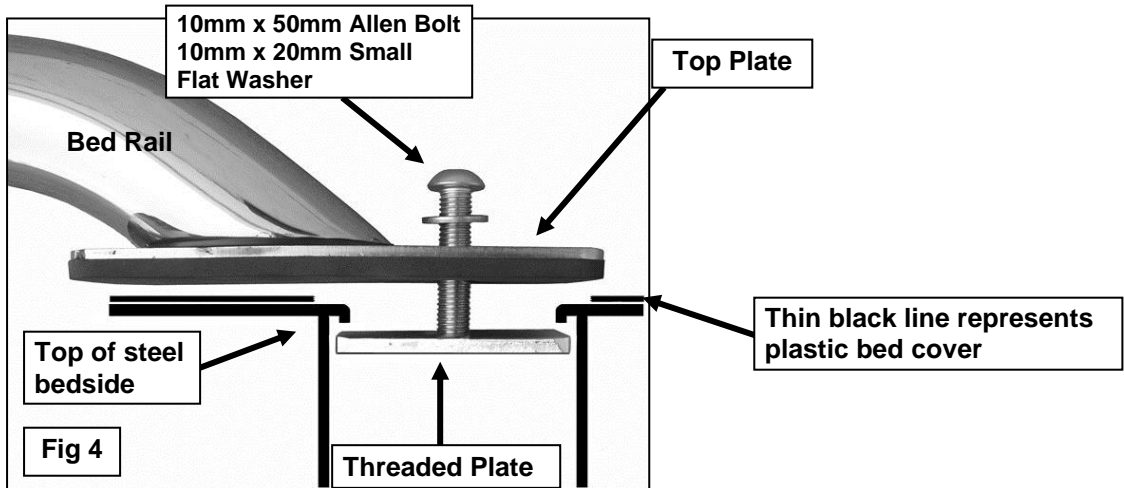

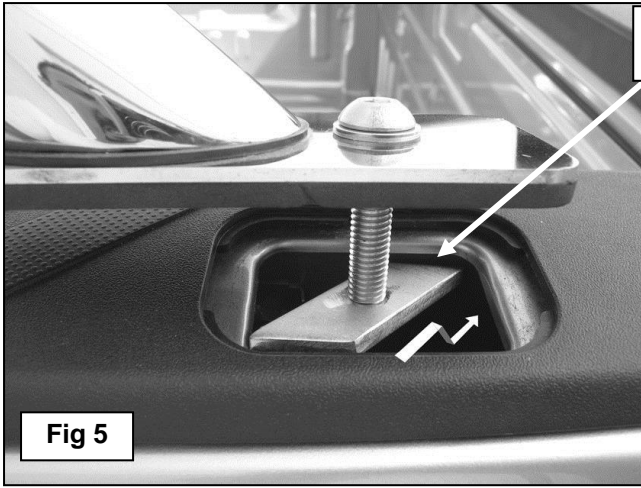

Fig 5

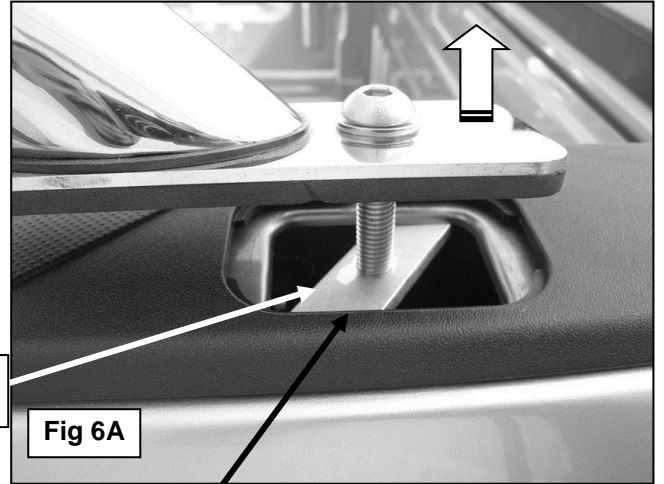

Fig 6A

Smaller angled plate pictured

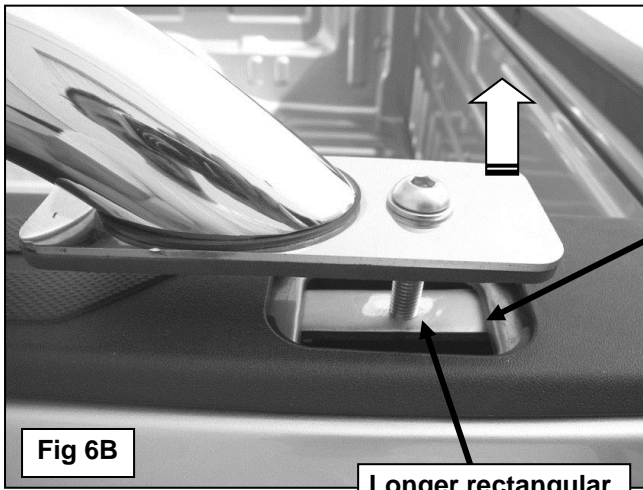

Fig 6B

Longer rectangular plate pictured



Fig 7

10mm x 50mm Allen Bolt  
10mm x 20mm Small Flat Washer



Complete Installation

## PARTS IDENTIFICATION GUIDE

**Driver Side tube packed using "Green" color foam sheet. Passenger Side tube packed using "White" color foam sheet**

No.	Parts Identification
1	Passenger / Right 'Rear' Bracket marked "PR"
2	Driver / Left 'Rear' Bracket marked "DR"
3	Passenger / Right 'Center' Bracket marked "PC"
4	Driver / Left 'Center' Bracket marked "DC"
5	Passenger / Right 'Front' Bracket marked "PF"
6	Driver / Left 'Front' Bracket marked "DF"

### Note:

- > This guide is to identify the parts and not a reference for part count.
- > For part count, refer Parts List.
- > Product / Bracket image is representative and actual design may vary.

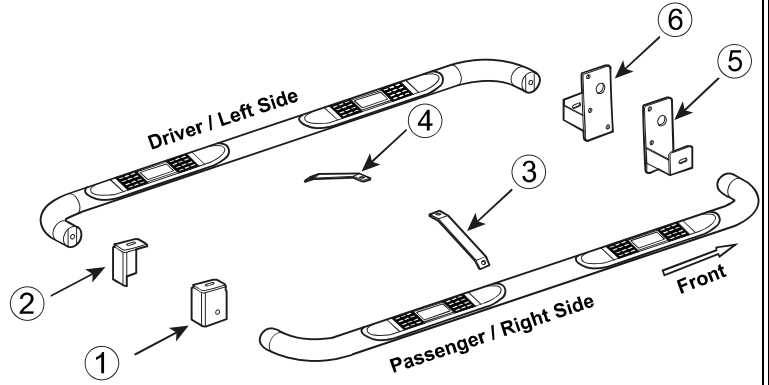

## PRODUCT CARE

- Periodically check the product to ensure all fasteners are tight and components are intact.
- Regular waxing is recommended to protect the finish of the product.
- **Use ONLY Non-Abrasive automotive wax.** Use of any soap, polish or wax that contains an abrasive is detrimental and can scratch the finish leading to corrosion.
- Aluminum polish may be used to polish small scratches and scuffs for **Stainless Steel finish.**
- Mild soap may be used to clean the product for both **Stainless Steel and Black finish.**

## FAQ's

### 1. Hardware's are not of correct size.

*In GMC / Chevrolet truck model 2006 & up, customer needs to reuse the factory body bolts to install the bracket. If your vehicle is not GMC / Chevrolet 2006 & up, ensure that holes are not partially covered with any plastic grommet or rust? If it is, remove the plastic grommet & rust from the thread holes & re-try the installation.*

### 2. Mounting Bracket are not getting Installed properly.

*In some cases Illustration images shown in Installation manual may not be the exactly same as per actual vehicle images ,also if Driver / Passenger side mounting brackets are very identical in the design, suggest referring Parts Identification guide to avoid fitment issue.*

### 3. Products are thumping / rattling after installation.

*Ensure that all required mounting brackets / hardware's are installed & tighten correctly. Suggest using white lithium / regular grease between the metal to metal contact surfaces.*

### 4. Side Bar is not aligning with vehicle / Step Pads are not aligning with vehicle doors.

*Side bar may be interchanged or mounting brackets are not installed at the correct position in the vehicle. Refer Parts identification guide.*

### 5. Missing / Excess Hardware.

*Recheck hardware count as per the part list.*

### 6. Product not installing properly.

*Ensure make model year, cab length and bed size of your vehicle is listed in the application. All installation steps are followed correctly.*



**BULL BAR**



**GRILLE GUARDS**



**BED RAILS**



**RUNNING BOARDS**