

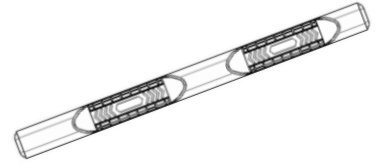

6" Oval Nerf Bar

Part No. A8245S/B



Fits: 2010-2015 Dodge Ram 2500/3500 Mega Cab

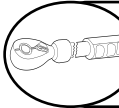

REMOVE CONTENTS FROM BOX. VERIFY ALL PARTS ARE PRESENT.

READ INSTRUCTIONS CAREFULLY BEFORE STARTING INSTALLATION.

DO NOT OVER TORQUE. STANDARD OPERATING LOAD FOR TIGHTEN BODY MOUNT NUTS & BOLTS VARIES FROM 45 TO 65 FOOT POUND.



60-180 min



Cutting Not Required



Drilling Not Required

PARTS LIST:

Qty	Part Description	Qty	Part Description
1	Driver/Left Sidebar	5	12mm Hex Nuts
1	Passenger/Right Sidebar	6	10-1.5mm x 35mm Hex Bolts
1	Driver Front Mounting Bracket	6	10mm x 27mm OD x 3mm Flat Washers
1	Driver Front Support Bracket	6	10mm Lock Washers
1	Driver Center Mounting Bracket	7	8mm-1.25 x 30 Hex Bolt
2	Passenger Front and Center Mounting Brackets	12	8mm-1.25 x 25mm Hex Bolts
1	Driver Rear Mounting Bracket	20	8mm x 24mm x 2mm Flat Washers
1	Passenger Rear Mounting Bracket	18	8mm Lock Washers
6	12mm Plastic Retainers	1	8mm Nylon Lock Nuts
6	12mm x 35mm Bolt x 10mm Nut Plates	2	6mm x 25mm Hex Bolts
5	12mm x 32mm OD x 3mm Flat Washers	4	6mm x 22mm x 2mm Flat Washers
5	12mm Lock Washers	2	6mm Nylon Lock Nuts

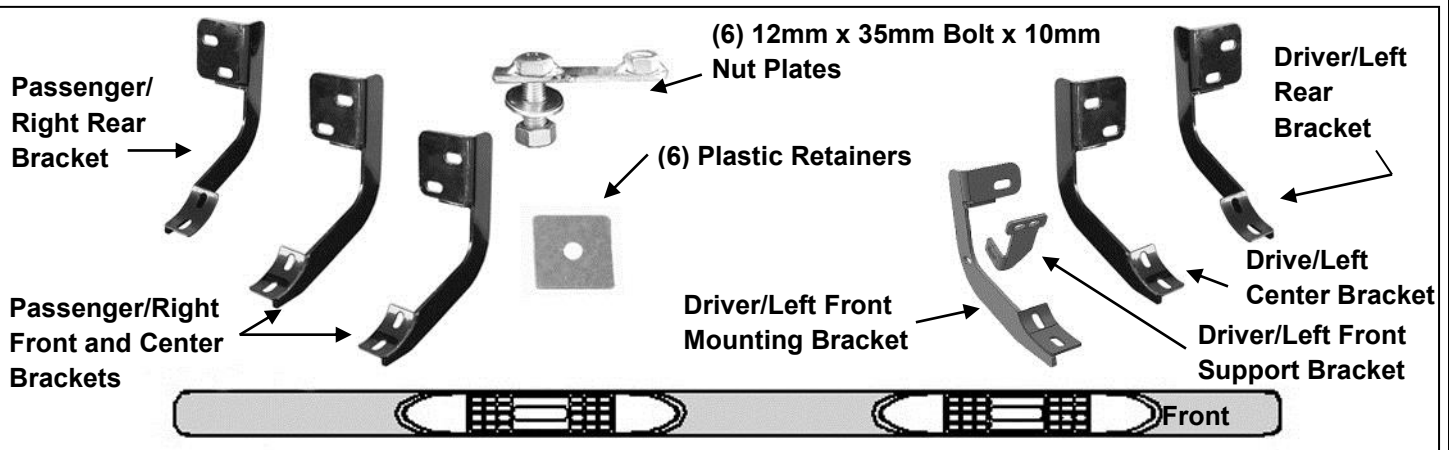

INSTALLATION PROCEDURE:

- Starting at the driver side-front of the vehicle, remove the sealing tape covering the factory holes on the side of the inner panel, (Figure 1).
- Determine the correct procedure to attach the driver side front Bracket for your model/year:

Models without factory threaded inserts in body panel: Partially thread a 12mm Plastic Retainer onto the threaded end of a 12mm Bolt and Nut Plate, (Figure 2). Insert the Bolt and Nut Plate into the oval hole and tighten the Plastic Retainer, (Figure

3). NOTE: The Plastic Retainer is designed to keep the Bolt/Nut Plate from falling into the body panel and to aid in Bracket installation.

- a. Select the driver side front Mounting Bracket, **(Figure 5)**. Rotate the 12mm Bolt and Nut plate until the threaded nut lines up with the hole in the Mounting Bracket and body, **(Figure 3)**. Attach the Bracket to the threaded Nut Plate with (1) 10mm x 35mm Hex Bolt, (1) 10mm Lock Washer and (1) 10mm Flat Washer, **(Figures 5 & 7)**. Do not fully tighten hardware at this time.

Models with factory threaded inserts:

- a. Attach the driver side Front Bracket to the threaded insert with (1) 8mm x 30mm Hex Bolt, (1) 8mm Lock Washer and (1) 8mm Flat Washer, **(Figures 4, 5 & 7)**. Leave hardware loose.
3. Next, select the driver side front Support Bracket. Attach the Bracket to the back of the front Bracket with (1) 8mm x 30mm Hex Bolt, (2) 8mm Flat Washers and (1) 8mm Nylon Lock Nut, **(Figures 5 & 7)**. Rotate the Support Bracket to the back of the pinch weld. Line up the slot in the top of the Support Bracket with the (2) factory holes in the pinch weld. Attach the Bracket to the pinch weld with (2) 6mm Hex Bolts, (4) 6mm Flat Washers and (2) 6mm Nylon Lock Nuts, **(Figures 6 & 7)**. Do not fully tighten hardware at this time. **IMPORTANT:** 2009-10 models are not equipped with factory holes and will require drilling through the pinch weld to attach the Support Bracket. Do not drill through pinch weld at this time, **(see Step 8)**.
4. Move along the side of the body panel to the center mounting location, **(Figure 8)**. Select (1) 12mm Bolt/Nut Plate. Repeat **Step 3** to install the Bolt/Nut Plate. Select the driver side center Bracket. Attach the Bracket to the Bolt/Nut Plate with (1) 12mm Flat Washer, (1) 12mm Lock Washer and (1) 12mm Hex Nut, **(Figure 9)**. Do not tighten hardware at this time. Line up the remaining hole in the Bracket with the hole in the inner body panel. Rotate the Bolt and Nut Plate until the threaded end (Nut) lines up with the hole in the Bracket. Secure with (1) 10mm x 35mm Hex Bolt, (1) 10mm Lock Washer and (1) 10mm Flat Washer, **(Figure 9)**
 - a. **IMPORTANT NOTE:** Models with threaded insert, attach the Bracket to the threaded insert with (1) 8mm x 30mm Hex Bolt, (1) 8mm Lock Washer and (1) 8mm Flat Washer. The 10mm hardware will not be required **(Step 5)**. Snug but do not tighten hardware.
5. Move to the rear location, **(Figure 10)**. Repeat **Step 5** to install the rear Mounting Bracket. **VERY IMPORTANT:** The rear Mounting Brackets, **(Figure 11)**, are slightly different from the front and center brackets, (see illustration above-note bolt pattern on mounting plate).
6. Once all of the driver side Brackets have been installed, carefully position the driver Sidebar onto the (3) Mounting Brackets. Attach the Sidebar to the cradles on the Mounting Brackets with the included (6) 8mm x 25mm Hex Bolts, (6) 8mm Lock Washers, and (6) 8mm Flat Washers, **(Figure 12)**. Do not tighten hardware at this time. **IMPORTANT:** If you are having any difficulty with installation, check Mounting Bracket location first. Use the illustration on **Page 1** to identify the Mounting Brackets
7. Properly level and adjust the Sidebar and fully tighten all hardware.

2009-10 models requiring drilling for driver side front Support Bracket:

- a. Make sure the Sidebar is level to the vehicle. Line up the slot on the Support Bracket with the back of the pinch weld. Mark the location of the slot onto the pinch weld.
- b. Drill (2) 1/4" holes through the pinch weld. **IMPORTANT:** Do not drill too close to the bottom edge of the pinch weld. Drill the holes toward the outside of the marked slot.
- c. Attach the Support Bracket to the pinch weld with (2) 6mm Hex Bolts, (4) 6mm Flat Washers and (2) 6mm Nylon Lock Nuts, **(Figures 6 & 7)**. Check for level then fully tighten all hardware.
8. Move to the passenger side of the vehicle. Remove tape covering front, center and rear locations. Repeat **Steps 5—7** for passenger side Mounting Bracket installation, **(Figure 13)**. **NOTE:** Refer to the illustration on **Page 1** to identify the correct Mounting Bracket for each of the remaining locations.
9. Do periodic inspections to the installation to make sure that all hardware is secure and tight.

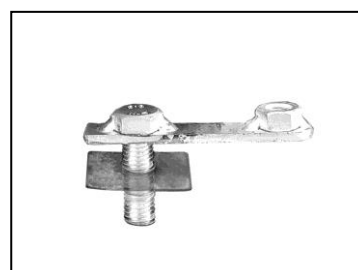
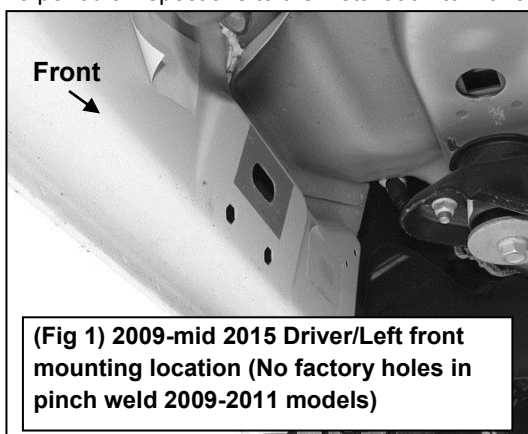

Driver Side Installation Pictured

**12mm x 35mm Bolt/10mm Nut Plate
12mm Plastic Retainer**

Rotate Bolt/Nut Plate to line up correct threaded hole with body panel and hole in Mounting Bracket (see arrow)

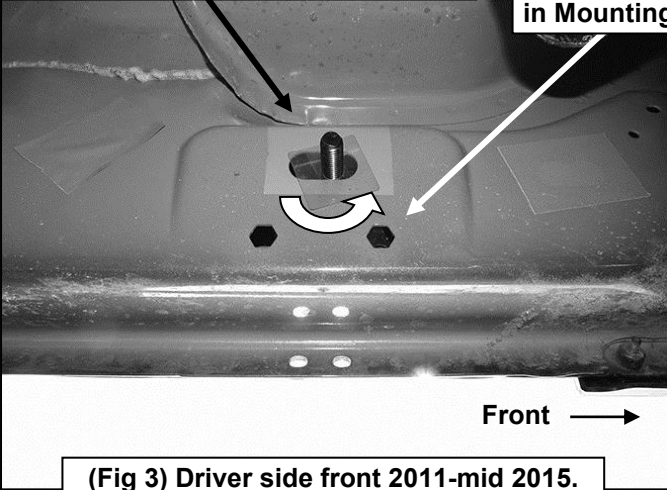

**(Fig 3) Driver side front 2011-mid 2015.
NOTE no threaded insert in body panel**

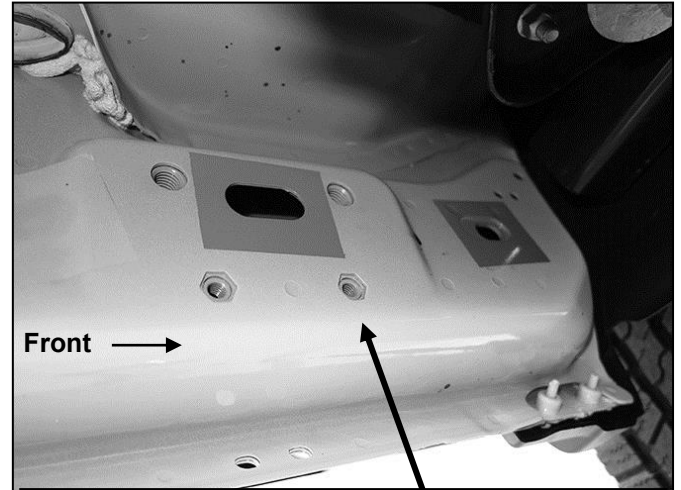

(Fig 4) Driver side front mid 2015-on example of all models with factory installed threaded inserts

**8mm x 30mm Hex Bolt
(2) 8mm Flat Washers
8mm Nylon Lock Nut**

**Models without threaded insert using Bolt/Nut Plate, use:
10mm x 35mm Hex Bolt
10mm Lock Washer
10mm Flat Washer**

**Models with threaded insert use:
8mm x 30mm Hex Bolt
8mm Lock Washer
8mm Flat Washer**

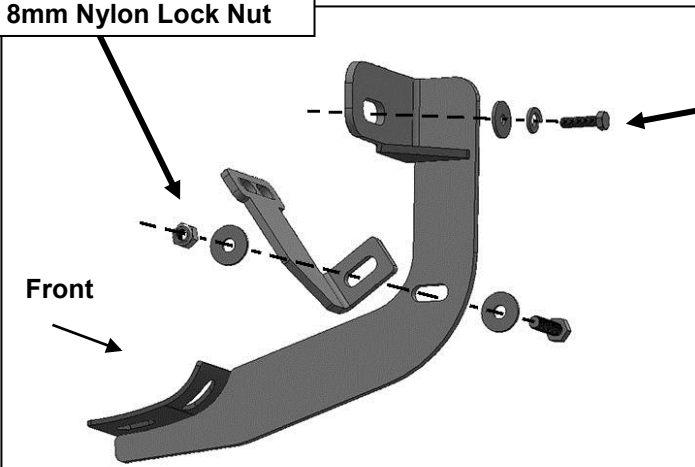

(Fig 5) Driver/Left front Mounting Bracket assembly

**(2) 6mm Hex Bolt
(4) 6mm Flat Washers
(2) 6mm Nylon Lock Nut**

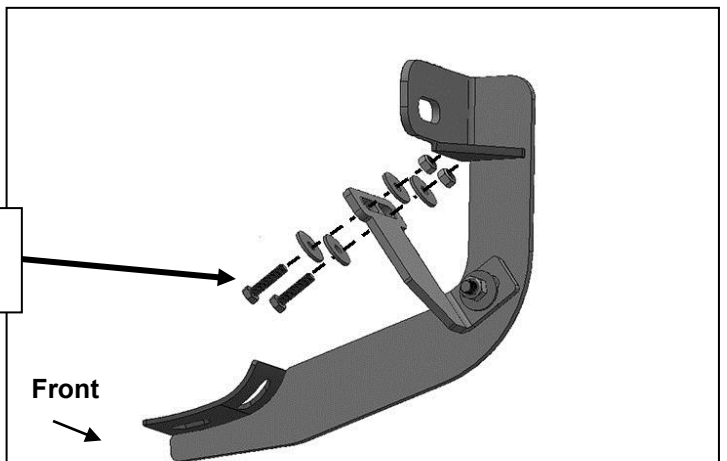

(Fig 6) Attach Support Bracket to back of pinch weld

Driver Side Installation Pictured

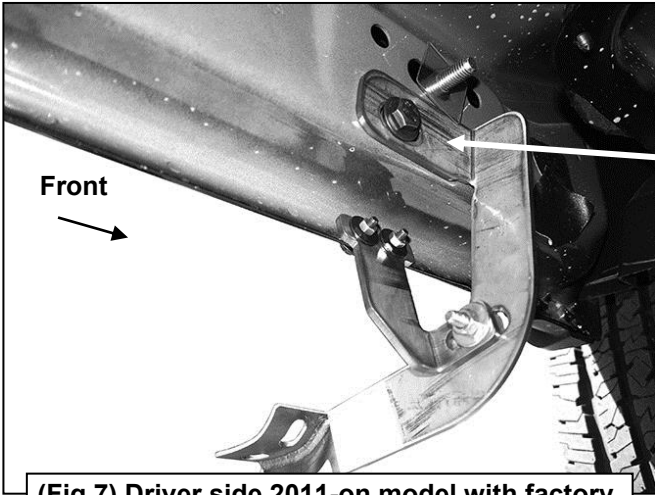

Models without threaded insert using Bolt/Nut Plate, use:
 10mm x 35mm Hex Bolt
 10mm Lock Washer
 10mm Flat Washer

Models with threaded insert use:
 8mm x 30mm Hex Bolt
 8mm Lock Washer
 8mm Flat Washer

(Fig 7) Driver side 2011-on model with factory holes in pinch weld pictured.

IMPORTANT: 2009-2010 models without holes in pinch weld will require drilling 1/4" holes through pinch weld to attach driver side front support bracket. Do complete installation of sidebars first, level sidebar before drilling holes for support bracket.

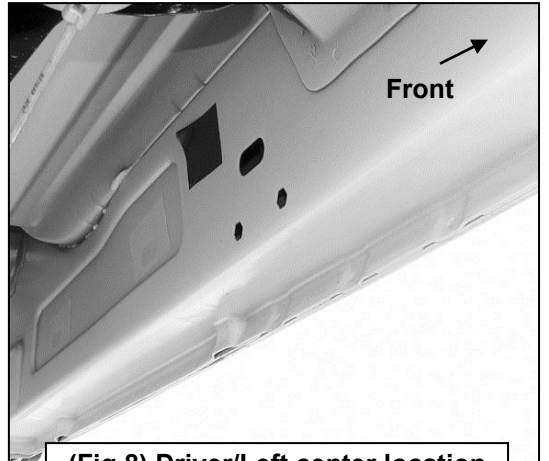

(Fig 8) Driver/Left center location

12mm Flat Washer
 12mm Lock Washer
 12mm Hex Nut

Models without threaded insert using Bolt/Nut Plate, use:
 10mm x 35mm Hex Bolt
 10mm Lock Washer
 10mm Flat Washer

Models with threaded insert use:
 8mm x 30mm Hex Bolt
 8mm Lock Washer
 8mm Flat Washer

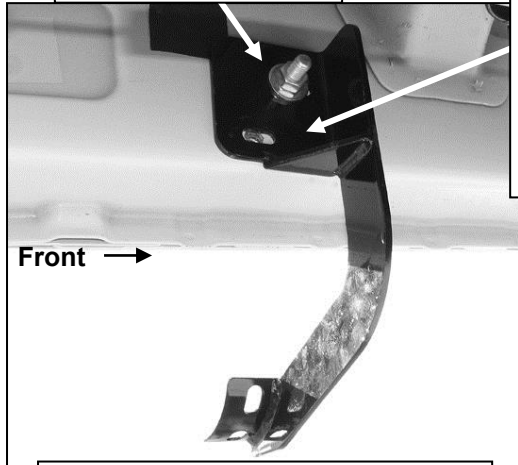

(Fig 9) Driver/Left center Bracket

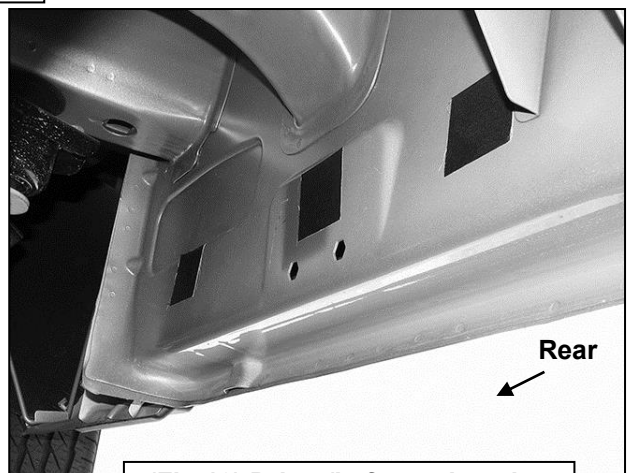

(Fig 10) Driver/Left rear location

12mm Flat Washer
12mm Lock Washer
12mm Hex Nut

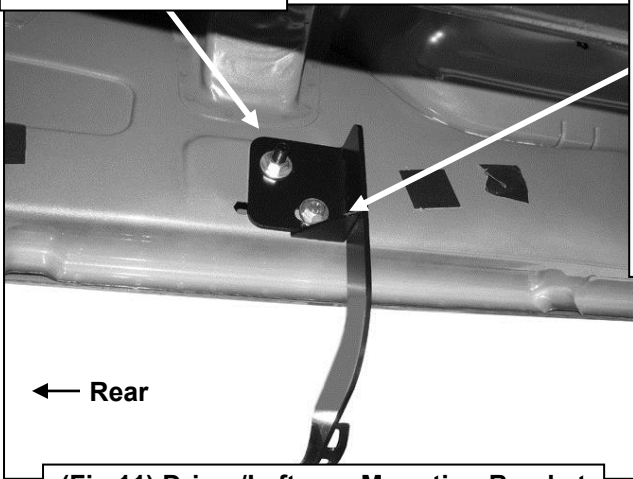

(Fig 11) Driver/Left rear Mounting Bracket

Models without threaded insert using Bolt/Nut Plate, use:
10mm x 35mm Hex Bolt
10mm Lock Washer
10mm Flat Washer

Models with threaded insert use:
8mm x 30mm Hex Bolt
8mm Lock Washer
8mm Flat Washer

IMPORTANT: The rear Mounting Brackets look similar to the front and center brackets but they are unique. Note the reversed bolt pattern on the mounting plate and forward facing cradle for sidebar.

8mm x 25mm Hex Bolts
8mm Flat Washers
8mm Lock Washers

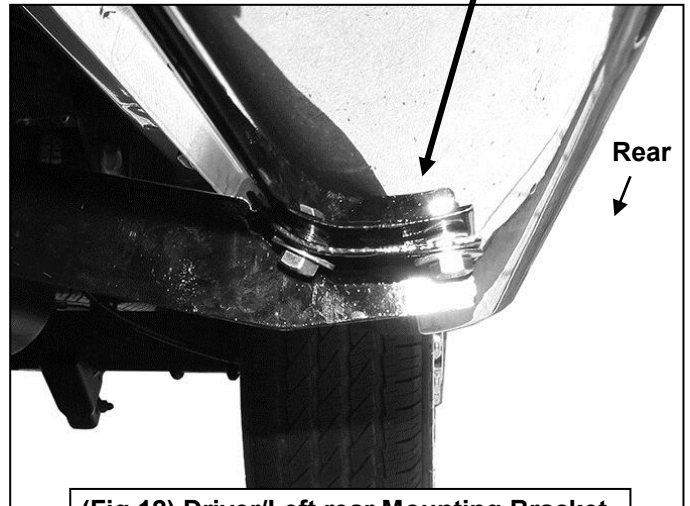

(Fig 12) Driver/Left rear Mounting Bracket

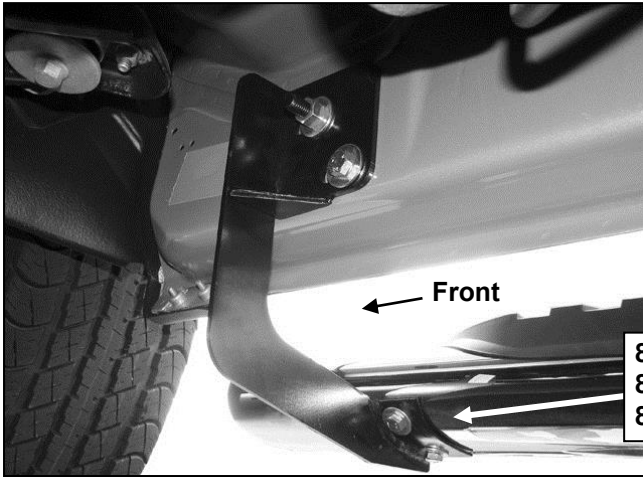

(Fig 13) Passenger/right front Mounting Bracket

8mm x 25mm Hex Bolts
8mm Flat Washers
8mm Lock Washers



Installation Complete

PARTS IDENTIFICATION GUIDE

Driver Side tube packed using "Green" color foam sheet. Passenger Side tube packed using "White" color foam sheet

No.	Parts Identification
1	Passenger / Right 'Rear' Bracket marked "PR"
2	Driver / Left 'Rear' Bracket marked "DR"
3	Passenger / Right 'Center' Bracket marked "PC"
4	Driver / Left 'Center' Bracket marked "DC"
5	Passenger / Right 'Front' Bracket marked "PF"
6	Driver / Left 'Front' Bracket marked "DF"

Note:

- This guide is to identify the parts and not a reference for part count.
- For part count, refer Parts List.
- Product / Bracket image is representative and actual design may vary.

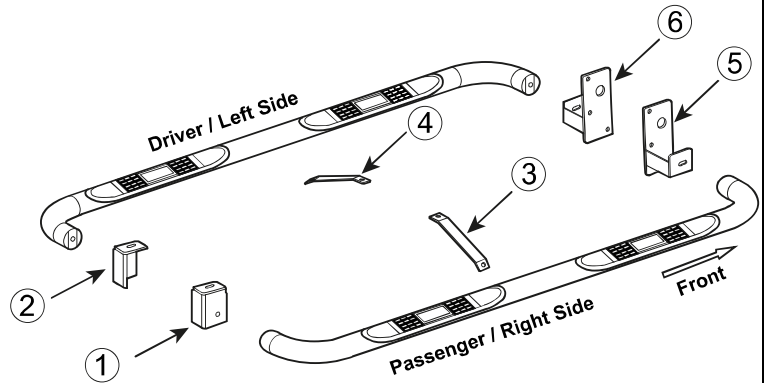

PRODUCT CARE

- Periodically check the product to ensure all fasteners are tight and components are intact.
- Regular waxing is recommended to protect the finish of the product.
- **Use ONLY Non-Abrasive automotive wax.** Use of any soap, polish or wax that contains an abrasive is detrimental and can scratch the finish leading to corrosion.
- Aluminum polish may be used to polish small scratches and scuffs for **Stainless Steel finish.**
- Mild soap may be used to clean the product for both **Stainless Steel and Black finish.**

FAQ's

1. Hardware's are not of correct size.

In GMC / Chevrolet truck model 2006 & up, customer needs to reuse the factory body bolts to install the bracket. If your vehicle is not GMC / Chevrolet 2006 & up, ensure that holes are not partially covered with any plastic grommet or rust? If it is, remove the plastic grommet & rust from the thread holes & re-try the installation.

2. Mounting Bracket are not getting Installed properly.

In some cases Illustration images shown in Installation manual may not be the exactly same as per actual vehicle images ,also if Driver / Passenger side mounting brackets are very identical in the design, suggest referring Parts Identification guide to avoid fitment issue.

3. Products are thumping / rattling after installation.

Ensure that all required mounting brackets / hardware's are installed & tighten correctly. Suggest using white lithium / regular grease between the metal to metal contact surfaces.

4. Side Bar is not aligning with vehicle / Step Pads are not aligning with vehicle doors.

Side bar may be interchanged or mounting brackets are not installed at the correct position in the vehicle. Refer Parts identification guide.

5. Missing / Excess Hardware.

Recheck hardware count as per the part list.

6. Product not installing properly.

Ensure make model year, cab length and bed size of your vehicle is listed in the application. All installation steps are followed correctly.