

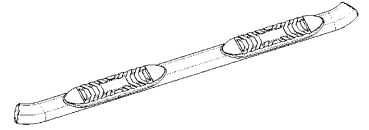

# 5" Oval Bent End Nerf Bar

Part No.A7069S/B



Fits: 2009-2014 Ford F150 Super Cab



REMOVE CONTENTS FROM BOX. VERIFY ALL PARTS ARE PRESENT.



60-180 min

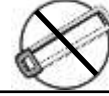

CUTTING NOT REQUIRED



DRILLING NOT REQUIRED



READ INSTRUCTIONS CAREFULLY BEFORE STARTING INSTALLATION.

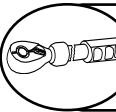

DO NOT OVER TORQUE. STANDARD OPERATING LOAD FOR TIGHTEN BODY MOUNT NUTS & BOLTS VARIES FROM 45 TO 65 FOOT POUND.

### PARTS LIST:

Qty	Part Description	Qty	Part Description
1	Driver/Left Side Bar	16	8-1.25mm x 25mm Hex Bolts
1	Passenger/Right Side Bar	8	8mm x 28mm OD x 3mm Flat Washers
2	Driver/Left Front-Passenger/Right Rear Mounting Brackets	24	8mm x 24mm OD x 2mm Flat Washers
2	Passenger/Right Front- Driver/Left Rear Mounting Brackets	24	8mm Lock Washers
8	8mm Deep Clip Nuts	8	8mm Hex Nuts
8	8-1.25mm x 30mm Hex Bolts		

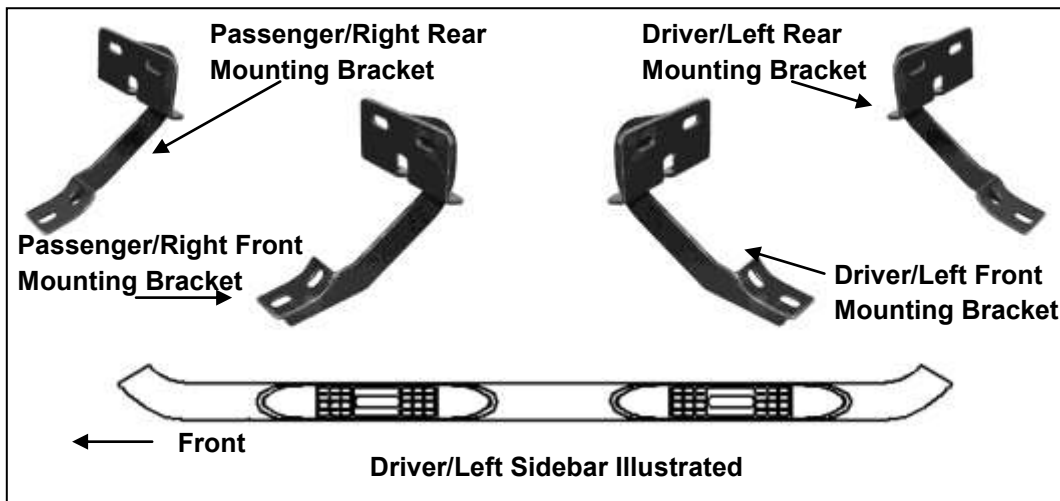

## PROCEDURE:

1. REMOVE CONTENTS FROM BOX. VERIFY ALL PARTS ARE PRESENT. READ INSTRUCTIONS CAREFULLY BEFORE STARTING INSTALLATION.
2. Starting on the driver side of the vehicle, locate the (2) holes in the pinch weld to find the factory mounting holes in the inner side panel, **(Figure 1)**. **NOTE:** The inner holes may be covered with sealing tape or insulation. Slide the 8mm Clip Nuts into the opening with the nut towards the inside. Line up the threaded nut on the clip with the round holes, **(Figure 1)**.
3. Partially attach the driver side Mounting Bracket to the Clip Nuts with the included (2) 8mm x 30mm Hex Bolts, (2) 8mm Lock Washers and (2) 8mm x 28mm Large Flat Washers, **(Figure 2)**. Depending on model and year, the brake cable may be run on the inside or outside of the Bracket. Do not tighten hardware at this time. **NOTE:** The Cradle on the Front Mounting Bracket should face to the rear of the vehicle.

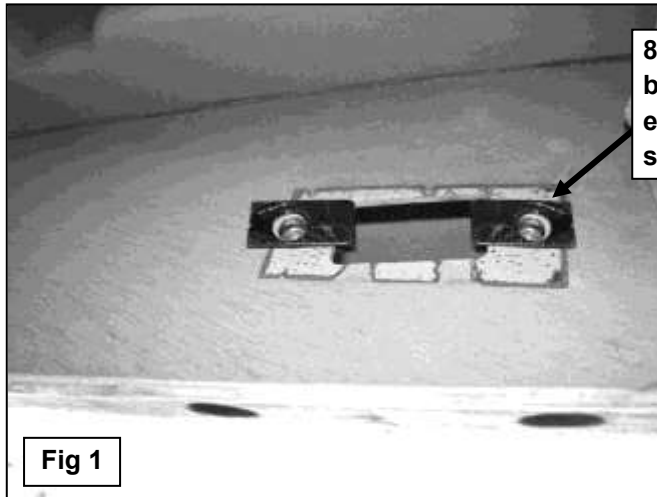

8mm Clip Nuts (hole in body panel shown for example only-location and shape may differ slightly)

8mm x 30mm Hex Bolts  
8mm Lock Washers  
8mm x 28mm Large Flat Washers



4. Align the bottom holes in the front Mounting Bracket with the (2) holes in the pinch weld. Bolt the Bracket to the pinch weld using the included (2) 8mm x 25mm Hex Bolts, (2) 8mm Lock Washers, (4) 8mm STD Flat Washers and (2) 8mm Hex Nuts, **(Figure 2)**. **NOTE:** Insert the bolts up from the bottom of the pinch weld and through the Bracket.
5. Repeat **Steps 2 – 4** for Rear Mounting Bracket installation. **NOTE:** The cradle on the Rear Mounting Bracket should face the front of the vehicle, **(Figures 3 & 4)**. The mounting holes will be the last set towards the back of the cab.

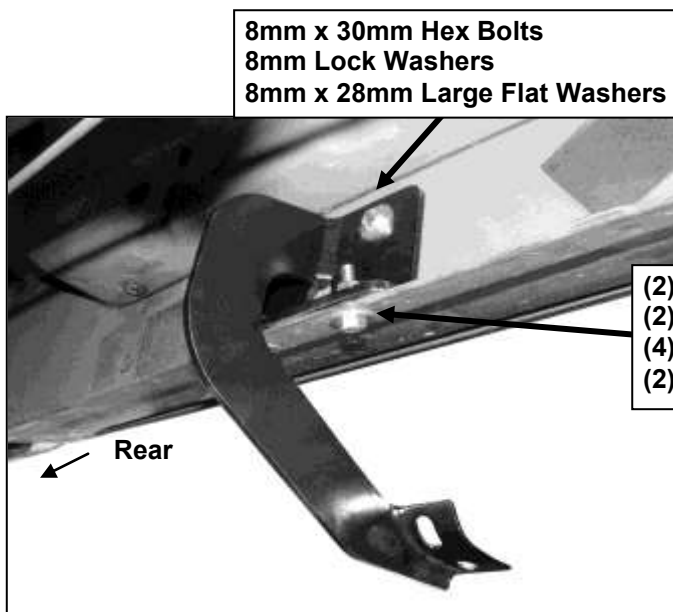

(Fig 3) Driver side-rear Mounting Bracket location

- Carefully position the Sidebar onto the Mounting Brackets and attach it using the included (4) 8mm x 25mm Hex Bolts, (4) 8mm Lock Washers and (4) 8mm STD Flat Washers, (**Figure 4**). Do not tighten hardware at this time.

(2) 8mm x 25mm Hex Bolts  
(2) 8mm Lock Washer  
(2) 8mm x 24mm STD Flat Washers

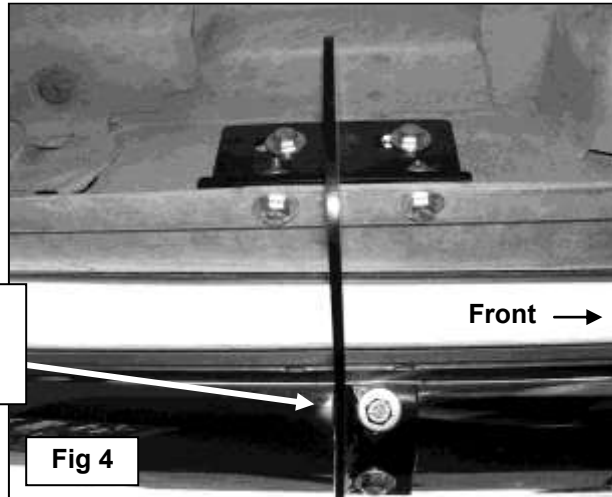

- Level and adjust the Sidebar properly and tighten all hardware.
- Repeat **Steps 2 – 7** for passenger Sidebar installation.
- Do periodic inspections to the installation to make sure that all hardware is secure and tight.

## PARTS IDENTIFICATION GUIDE

**Driver Side tube packed using "Green" color foam sheet. Passenger Side tube packed using "White" color foam sheet**

No.	Parts Identification
1	Passenger / Right 'Rear' Bracket marked "PR"
2	Driver / Left 'Rear' Bracket marked "DR"
3	Passenger / Right 'Center' Bracket marked "PC"
4	Driver / Left 'Center' Bracket marked "DC"
5	Passenger / Right 'Front' Bracket marked "PF"
6	Driver / Left 'Front' Bracket marked "DF"

### Note:

- This guide is to identify the parts and not a reference for part count.
- For part count, refer Parts List.
- Product / Bracket image is representative and actual design may vary.

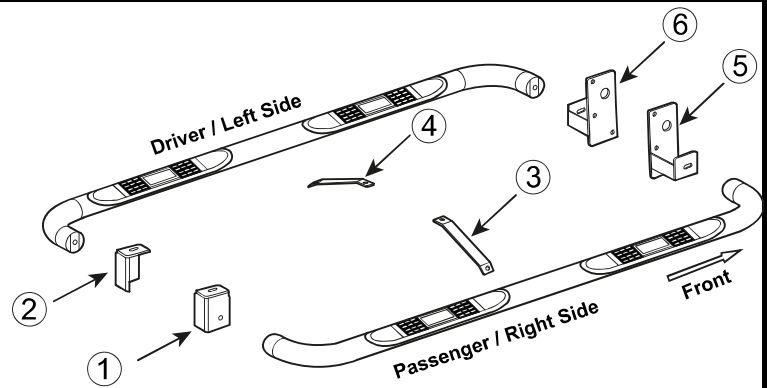

## PRODUCT CARE

- Periodically check the product to ensure all fasteners are tight and components are intact.
- Regular waxing is recommended to protect the finish of the product.
- **Use ONLY Non-Abrasive automotive wax.** Use of any soap, polish or wax that contains an abrasive is detrimental and can scratch the finish leading to corrosion.
- Aluminum polish may be used to polish small scratches and scuffs for **Stainless Steel finish.**
- Mild soap may be used to clean the product for both **Stainless Steel and Black finish.**

### 1. Hardware's are not of correct size.

*In GMC / Chevrolet truck model 2006 & up, customer needs to reuse the factory body bolts to install the bracket. If your vehicle is not GMC / Chevrolet 2006 & up, ensure that holes are not partially covered with any plastic grommet or rust? If it is, remove the plastic grommet & rust from the thread holes & re-try the installation.*

### 2. Mounting Bracket are not getting Installed properly.

*In some cases Illustration images shown in Installation manual may not be the exactly same as per actual vehicle images ,also if Driver / Passenger side mounting brackets are very identical in the design, suggest referring Parts Identification guide to avoid fitment issue.*

### 3. Products are thumping / rattling after installation.

*Ensure that all required mounting brackets / hardware's are installed & tighten correctly. Suggest using white lithium / regular grease between the metal to metal contact surfaces.*

### 4. Side Bar is not aligning with vehicle / Step Pads are not aligning with vehicle doors.

*Side bar may be interchanged or mounting brackets are not installed at the correct position in the vehicle. Refer Parts identification guide.*

### 5. Missing / Excess Hardware.

*Recheck hardware count as per the part list.*

### 6. Product not installing properly.

*Ensure make model year, cab length and bed size of your vehicle is listed in the application. All installation steps are followed correctly.*