



5" Oval Nerf Bar

Part No. A7041S/B



Fits: 2015 - Current
2017

Ford F150 Super Cab
Ford F250/350/450/550 Superduty Super Cab



60-180 min

Cutting Not
Required

Drilling Not
Required



REMOVE CONTENTS FROM BOX. VERIFY ALL PARTS ARE PRESENT.



READ INSTRUCTIONS CAREFULLY BEFORE STARTING INSTALLATION.

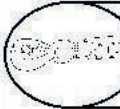

DO NOT OVER TORQUE. STANDARD OPERATING LOAD FOR TIGHTEN BODY MOUNT NUTS & BOLTS VARIES FROM 45 TO 65 FOOT POUND.

PARTS LIST:

Qty	Part Description	Qty	Part Description
1	Driver/left Sidebar	8	8-1.25mm x 25mm Hex Bolts
1	Passenger/right Sidebar	20	8mm x 22mm OD x 2mm Washers
4	Sidebar Brackets (use for left or right)	8	8mm Lock Washers
12	8mm Plastic Washers	12	8-1.25mm Nylon Lock Nuts

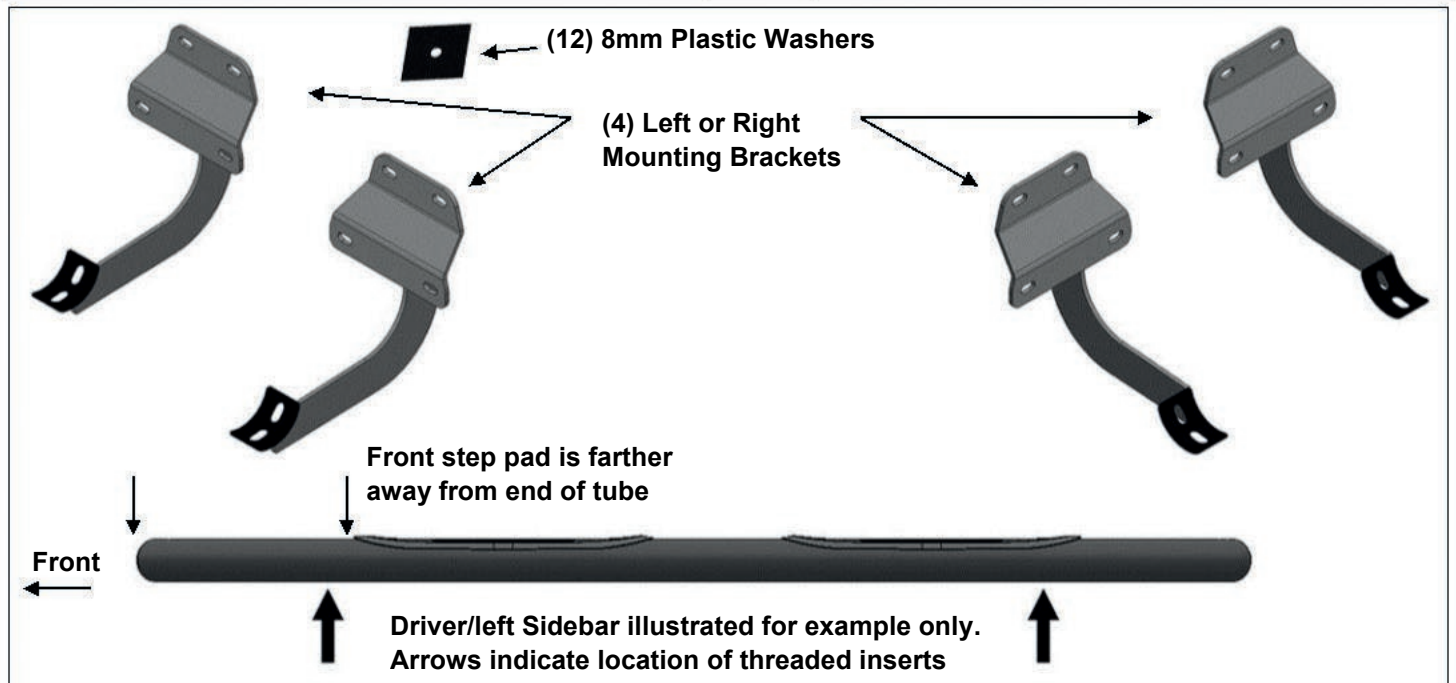

INSTALLATION PROCEDURE:

1. Start the installation under the driver side of the vehicle. Locate the front and rear factory running board mounting locations along the inner side of the body, (Figure 1).
2. Slide (1) Plastic Washer over each factory mounting stud in the body panel, (Figures 2 & 3). **IMPORTANT:** The Plastic Washers are designed to prevent corrosion between the aluminum body panel and the steel mounting brackets. **Do not install the Brackets without the Plastic Washers.**
3. Select (1) Mounting Bracket. **NOTE:** All (4) Brackets are universal and will fit left or right side. Attach the Mounting Bracket to the (3) factory studs with (3) 8mm Flat Washers and (3) 8mm Nylon Lock Nuts, (Figure 4). Snug but do not fully tighten the hardware.
4. Repeat Steps 1—3 to install the rear driver side Bracket.

5. Select the driver/left Sidebar. Carefully position the Sidebar onto the (3) Mounting Brackets. **IMPORTANT:** Do not slide, (front to back or rotate), the Sidebar on the Brackets or damage to the finish on the Sidebar may result. Attach the Sidebar to the Mounting Brackets with (4) 8mm x 25mm Hex Bolts, (4) 8mm Lock Washers and (4) 8mm Flat Washers, (Figure 5). Do not tighten hardware.
6. Level and adjust the Sidebar and tighten all hardware.
7. Repeat **Steps 1—6** to install the passenger/right Sidebar.
8. Do periodic inspections to the installation to make sure that all hardware is secure and tight.

Driver/left Side Installation Pictured

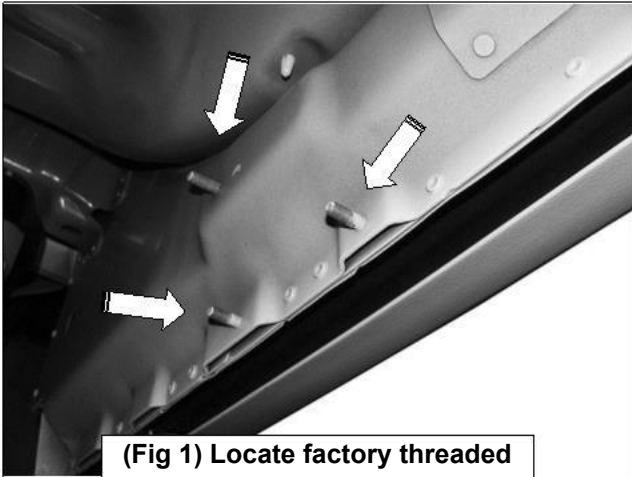

(Fig 1) Locate factory threaded studs. Driver side rear pictured

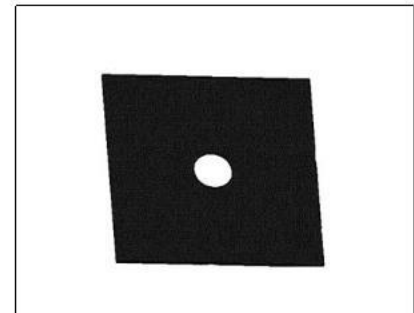

(Fig 2) Plastic Insulation Washer



(3) Plastic Insulation Washers

(Fig 3) Thread Plastic Washers onto all mounting studs. Driver side front pictured

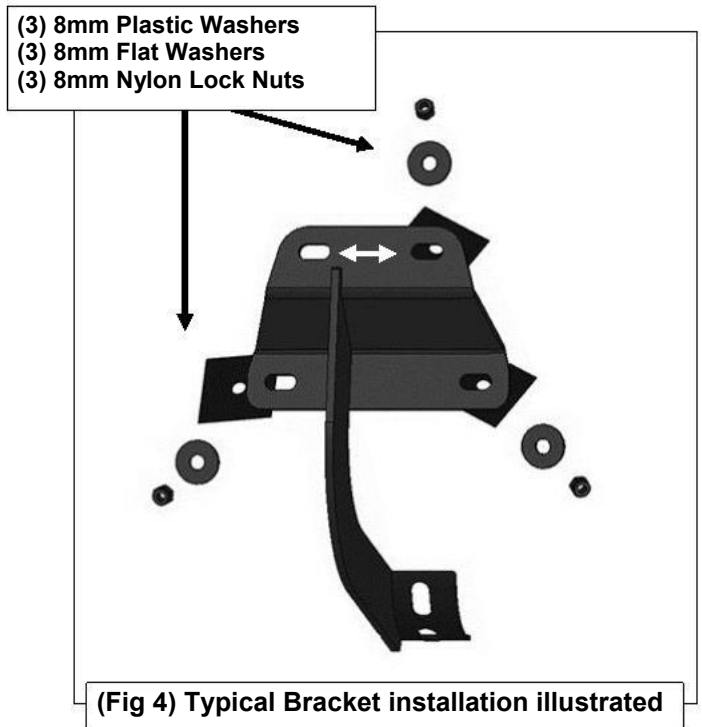

(Fig 4) Typical Bracket installation illustrated

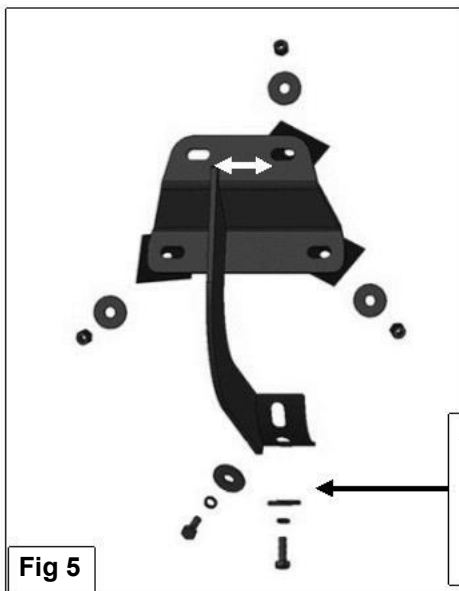

Fig 5

Attach Sidebar to each Bracket with:
 (2) 8mm x 25mm Hex Bolts
 (2) 8mm Lock Washers
 (2) 8mm Flat Washers

PARTS IDENTIFICATION GUIDE

Driver Side tube packed using "Green" color foam sheet. Passenger Side tube packed using "White" color foam sheet

No.	Parts Identification
1	Passenger / Right 'Rear' Bracket marked "PR"
2	Driver / Left 'Rear' Bracket marked "DR"
3	Passenger / Right 'Center' Bracket marked "PC"
4	Driver / Left 'Center' Bracket marked "DC"
5	Passenger / Right 'Front' Bracket marked "PF"
6	Driver / Left 'Front' Bracket marked "DF"

Note:

- This guide is to identify the parts and not a reference for part count.
- For part count, refer Parts List.
- Product / Bracket image is representative and actual design may vary.

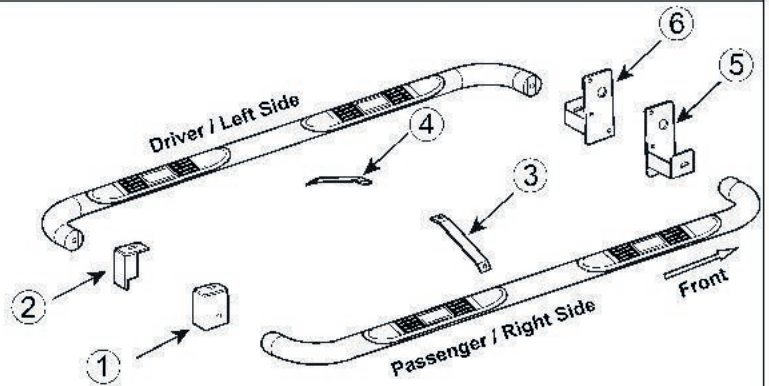

PRODUCT CARE

- Periodically check the product to ensure all fasteners are tight and components are intact.
- Regular waxing is recommended to protect the finish of the product.
- **Use ONLY Non-Abrasive automotive wax.** Use of any soap, polish or wax that contains an abrasive is detrimental and can scratch the finish leading to corrosion.
- Aluminum polish may be used to polish small scratches and scuffs for **Stainless Steel finish.**
- Mild soap may be used to clean the product for both **Stainless Steel and Black finish.**

FAQ's

1. Hardware's are not of correct size.

In GMC / Chevrolet truck model 2006 & up, customer needs to reuse the factory body bolts to install the bracket. If your vehicle is not GMC / Chevrolet 2006 & up, ensure that holes are not partially covered with any plastic grommet or rust? If it is, remove the plastic grommet & rust from the thread holes & re-try the installation.

2. Mounting Bracket are not getting Installed properly.

In some cases Illustration images shown in Installation manual may not be the exactly same as per actual vehicle images ,also if Driver / Passenger side mounting brackets are very identical in the design, suggest referring Parts Identification guide to avoid fitment issue.

3. Products are thumping / rattling after installation.

Ensure that all required mounting brackets / hardware's are installed & tighten correctly. Suggest using white lithium / regular grease between the metal to metal contact surfaces.

4. Side Bar is not aligning with vehicle / Step Pads are not aligning with vehicle doors.

Side bar may be interchanged or mounting brackets are not installed at the correct position in the vehicle. Refer Parts identification guide.

5. Missing / Excess Hardware.

Recheck hardware count as per the part list.

6. Product not installing properly.

Ensure make model year, cab length and bed size of your vehicle is listed in the application. All installation steps are followed correctly.