



# 5" Oval W2W Nerf Bar

## Part No. A7039S/B



Fits: **2007-Current Chevrolet Silverado 2500/3500 Crew Cab Long Bed 8 Ft**  
**2007-Current Chevrolet Silverado/Sierra 2500/3500 Crew Cab WITH 6.5ft Standard Bed**



60-180 min

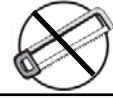

Cutting Not Required



Drilling Not Required



REMOVE CONTENTS FROM BOX. VERIFY ALL PARTS ARE PRESENT.



READ INSTRUCTIONS CAREFULLY BEFORE STARTING INSTALLATION.

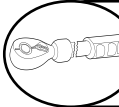

DO NOT OVER TORQUE. STANDARD OPERATING LOAD FOR TIGHTEN BODY MOUNT NUTS & BOLTS VARIES FROM **45 TO 65** FOOT POUND.

### PARTS LIST:

| Qty | Part Description                                    | Qty | Part Description                      |
|-----|---|-----|---------------------------------------|
| 1   | Driver/left Sidebar                                 | 33  | 8-1.25mm x 25mm Hex Bolt              |
| 1   | Passenger/right Sidebar                             | 33  | 8mm x 24mm x 2mm Flat Washer          |
| 1   | Passenger/right Front Upper Bracket (all incl. DEF) | 33  | 8mm Lock Washer                       |
| 1   | Passenger/right Front Lower Bracket (all incl. DEF) | 1   | 8mm Bolt Plate                        |
| 7   | 5" Sidebar Brackets                                 | 1   | 8mm Nylon Lock Nut (use w-bolt plate) |
| 15  | 8-1.25mm Clip-On Nuts                               |     |                                       |

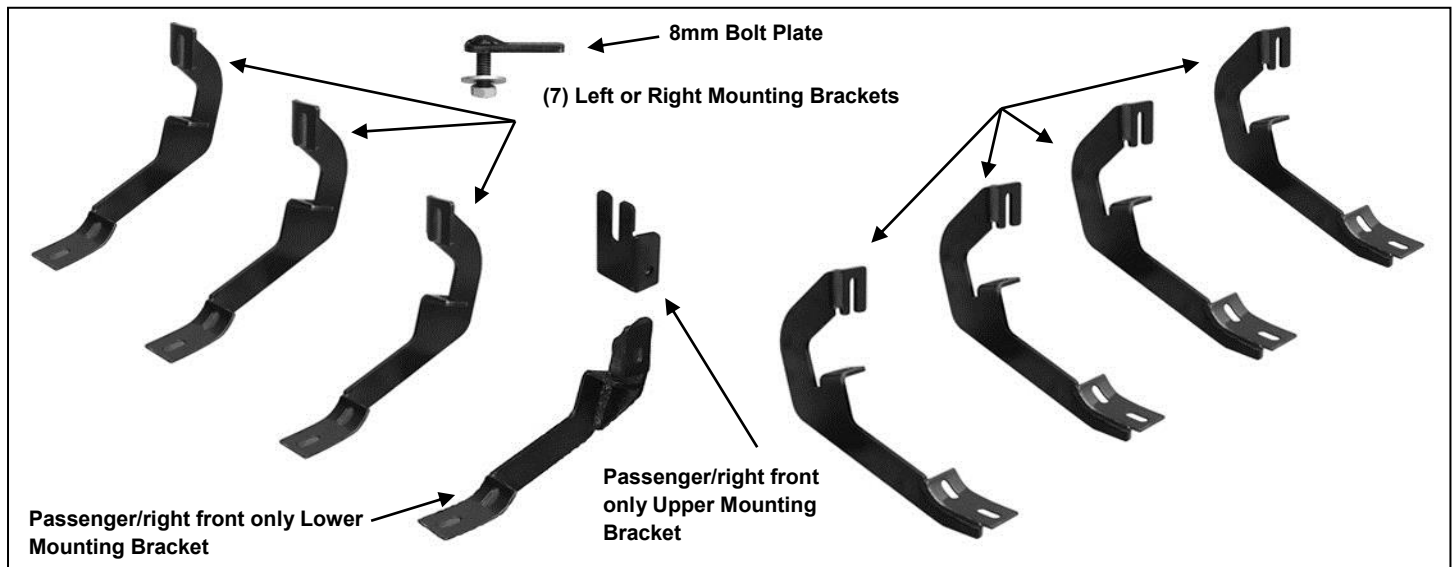

### INSTALLATION PROCEDURE:

**ASSISTANCE IS RECOMMENDED. ON MODELS WITH DEF TANK, SELECT A FLAT, LEVEL AREA FOR INSTALLATION.**

1. Start the installation under the driver side of the vehicle. Locate the 5 tabs along the bottom edge of the body, (pinch weld). Mounting Brackets will bolt to the 1st, 2nd, (just in front of center of cab), 4th and 5th mounting tabs, **(Figure 1)**. Directly above each tab is a top mounting location on the side of the body panel. Hold a Bracket up in place to help determine the mounting holes to use along the body.
2. Determine the correct procedure for your model year and each Bracket location.  
**Bottom mounting location on the edge of the pinch weld.**

**Flat tab on pinch weld with factory installed weld nut:**

Thread hex bolt into weld nut from the backside-down to clear paint from threads, (Figure 2).

**Flat tab on pinch weld with hole:**

Select (1) 8mm Clip Nut. Slide the Clip Nut over the tab with the nut facing up behind the tab, (Figures 3—5). Line up threaded nut with hole in tab. Repeat for each mounting location.

**Top mounting location on the side of the body panel.**

**Models with factory installed threaded insert in body panel:**

Thread 8mm Hex Bolt into threaded insert to clear paint as required, (Figures 2 & 3).

**Large and small hole in side of body panel:**

Remove the rubber plug from the larger hole, (Figure 4). Select (1) 8mm Clip Nut. Slide the Clip Nut into the larger hole. Line up the threaded nut with the smaller hole, (Figure 5).

**Driver/Left Side Installation Pictured**

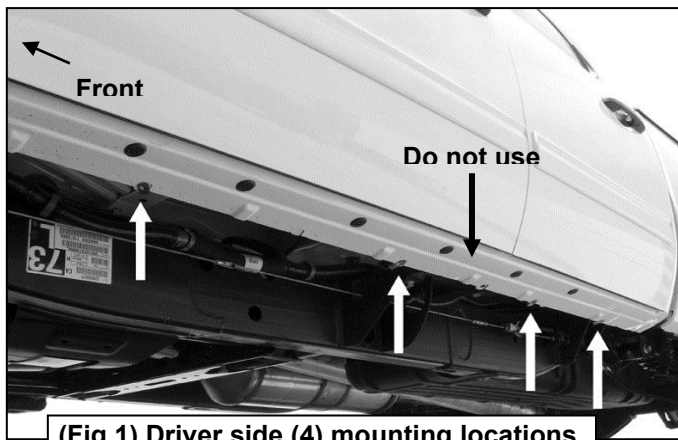

(Fig 1) Driver side (4) mounting locations

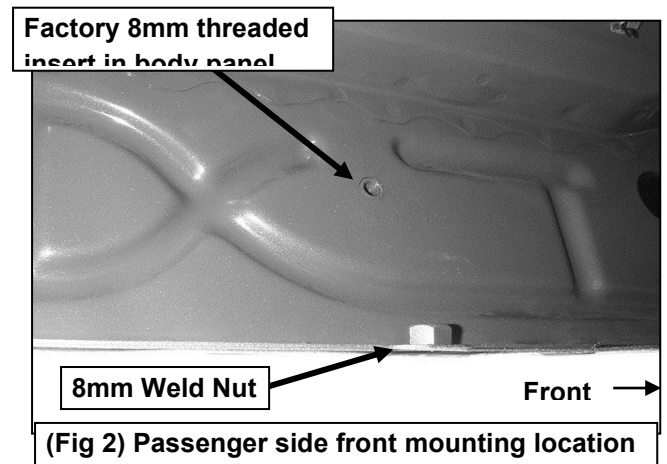

(Fig 2) Passenger side front mounting location

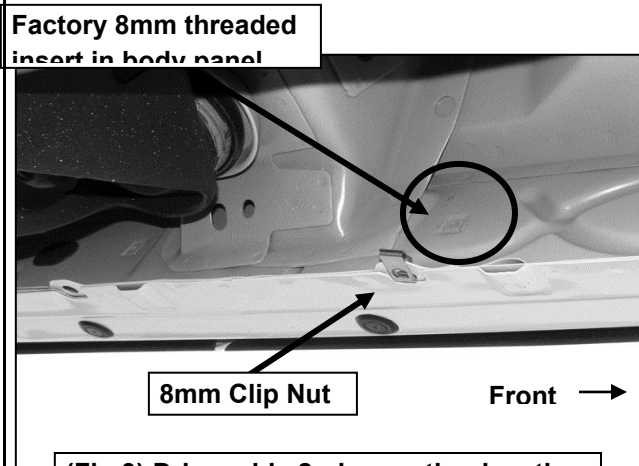

(Fig 3) Driver side 2nd mounting location

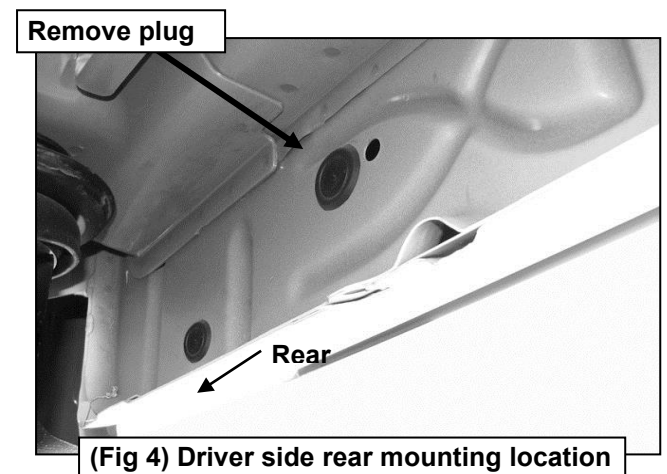

(Fig 4) Driver side rear mounting location

3. Select (1) Mounting Bracket. **NOTE:** (7) Brackets are universal and will fit left or right side. Bolt the Mounting Bracket to the Clip Nuts and/or the factory threaded holes with (2) 8mm Hex Bolts, (2) 8mm Lock Washers and (2) 8mm Flat Washers, (Figures 6 & 7). Snug but do not fully tighten the hardware.
4. Repeat **Steps 1—3** for the (3) remaining driver side Bracket installations, (Figure 8).

5. Select the driver/left sidebar. Carefully position the Driver Sidebar onto the (4) Mounting Brackets. **IMPORTANT:** Do not slide, (front to back or rotate), the Sidebar on the Brackets or damage to the finish on the Sidebar may result. Attach the Sidebar to the Mounting Brackets with (8) 8mm x 25mm Hex Bolts, (8) 8mm Lock Washers and (8) 8mm Flat Washers, **(Figure 8)**. Do not tighten hardware.
6. Level and adjust the Sidebar and tighten all hardware.

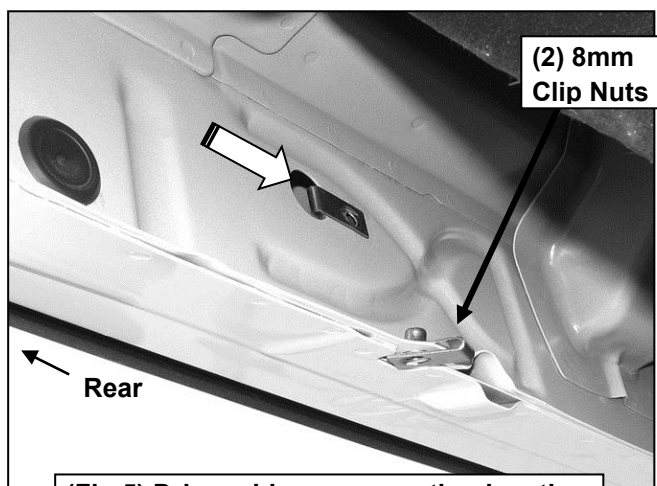

**(Fig 5) Driver side rear mounting location**

(2) 8mm x 25mm Hex Bolts  
(2) 8mm Lock Washers  
(2) 8mm Flat Washers

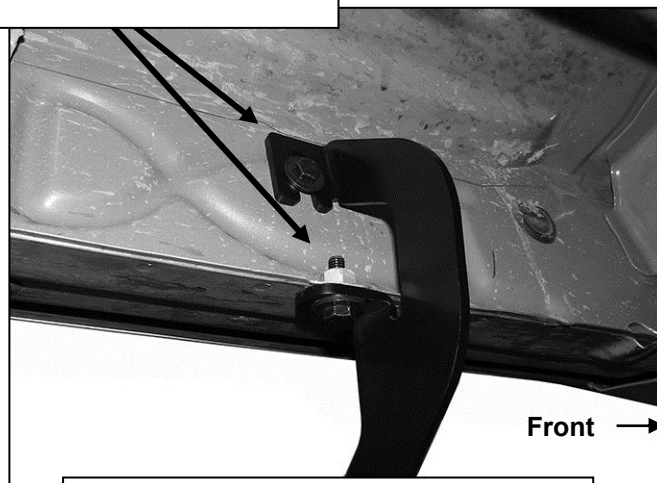

**(Fig 6) Driver/left front bracket installed**

(2) 8mm x 25mm Hex Bolts  
(2) 8mm Lock Washers  
(2) 8mm Flat Washers

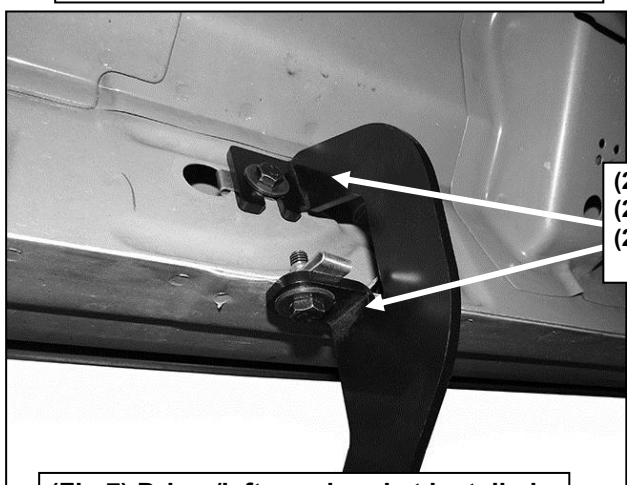

**(Fig 7) Driver/left rear bracket installed**

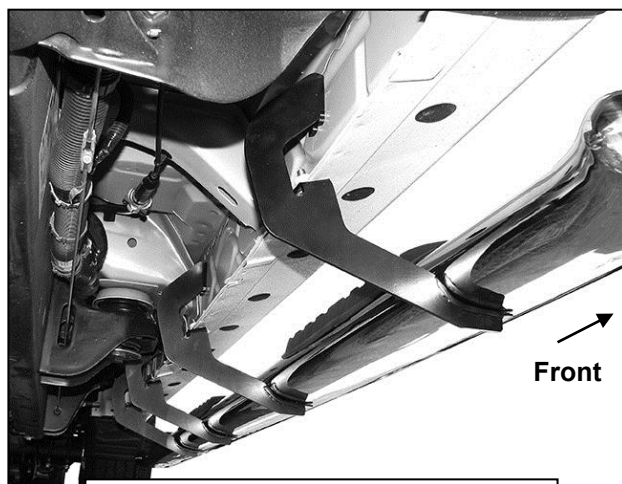

**(Fig 8) Driver/left brackets installed**

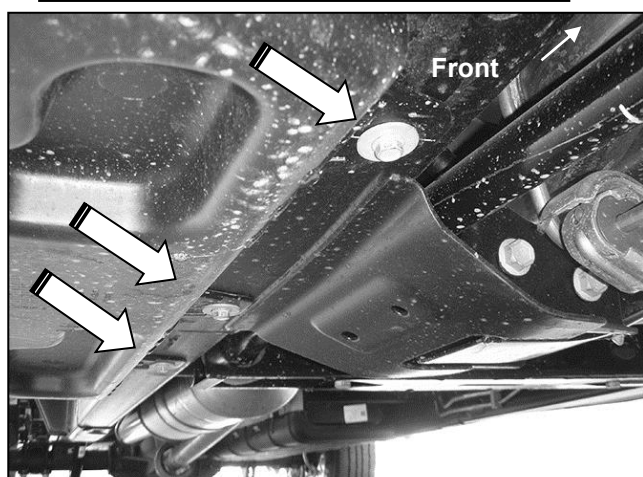

**(Fig 9) Passenger side front pictured with DEF tank cover. Remove (3) hex bolts to remove cover**

7. Move to the passenger side of the vehicle. On the passenger side front of the vehicle, determine if the vehicle is equipped with a plastic diesel exhaust fluid (DEF) tank, **(Figures 9 & 10)**.  
**Models without DEF tank, skip to Step 8.**

**Models with DEF tank:** The tank sits close to the side of the body. With specialized tools, the passenger front upper and lower Bracket can be installed but room is limited. It may be easier to drop the tank down to access the inner side of the body panel for upper bracket installation. Tank will not need to be removed, only dropped down for access to mounting location.  
**IMPORTANT:** If tank is full, it will be very heavy and assistance is highly recommended to avoid injury or damage to the

vehicle or the tank. It is recommended that installation is performed when the DEF tank is low on fluid before dropping the tank.

- a. On models with plastic lower tray under the tank, remove the (3) hex bolts attaching the tray to the frame, **(Figure 9)**.
- b. Release the tank filler hose. Release the plug for the sending unit on the top of the tank.
- c. Support the tank with a floor jack. Place a smooth flat surface, (wooden block for example), between the floor jack and the tank to avoid damaging the plastic tank. Do not push up on the tank; only support the weight of the tank with the jack.
- d. Remove the (2) bolts securing the tank straps to the vehicle, **(Figure 10)**. Tilt the straps to release from the brackets. Slowly lower the tank until the top of the tank is almost visible. Use blocks or stands to support the tank while installing the front Upper and Lower Brackets.
- e. Proceed to **Step 8**.

8. Locate the first tab on the edge of the pinch weld, **(Figures 2—4, 12)**. Select the Upper Bracket, **(Figure 11)**. Repeat **Steps 2 & 3** to attach the passenger front Upper Bracket to the side of the body panel, **(Figure 12)**. Do not tighten hardware at this time.

Remove (2) factory bolts to remove tank straps

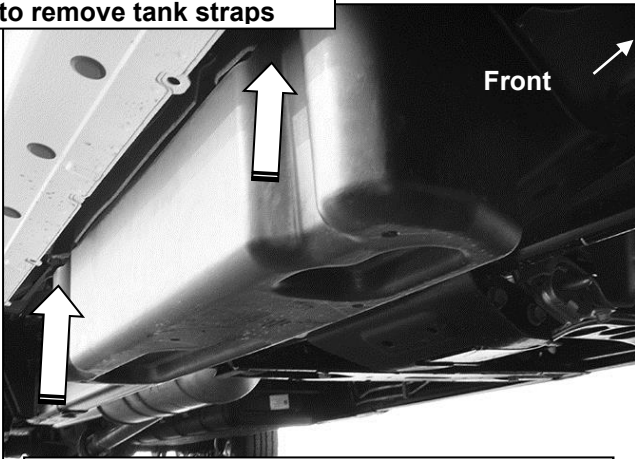

**(Fig 10) Passenger side DEF tank and cover**



**(Fig 11) Passenger/right Front Upper Bracket (all models)**

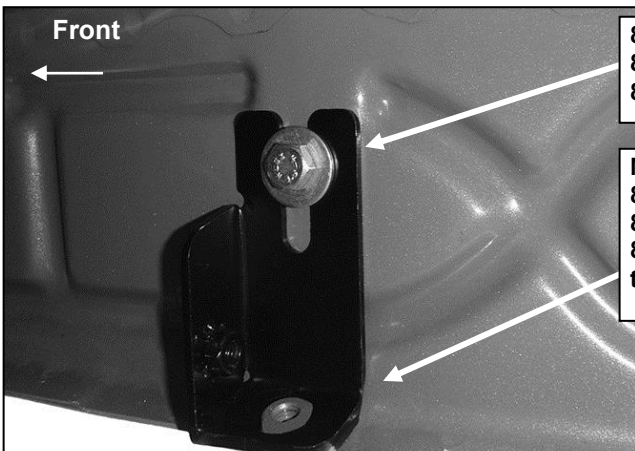

**(Fig 12) Slide Upper Bracket over weld nut (if equipped-see Figure 2)**

8mm x 25mm Hex Bolt  
8mm Lock Washer  
8mm Flat Washer

Models with weld nut on tab use:  
8mm x 25mm Hex Bolt  
8mm Lock Washer  
8mm Flat Washer  
to bolt Lower Bracket to weld nut



**(Fig 13) 8mm x 35mm Bolt Plate**

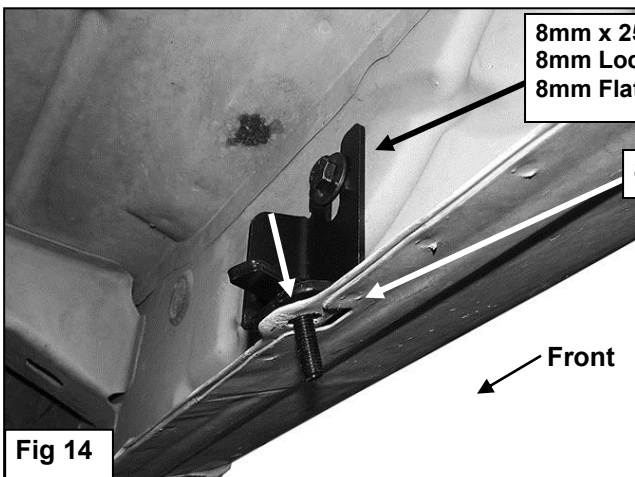

**Fig 14**

8mm x 25mm Hex Bolt  
8mm Lock Washer  
8mm Flat Washer

8mm Bolt Plate

On models with flat tab (see Fig. 3, 4 and 16), insert 8mm Bolt Plate (Fig 13) down through Upper Bracket and mounting tab

9. Line up the hole in the bottom of the Upper Bracket with the hole in the tab on the pinch weld.
  - a. **Models with a weld-nut:** Slide the Bracket over the weld-nut, (**Figure 12**). Attach the Lower Bracket to the bottom of the body and weld-nut with (1) 8mm x 25mm Hex Bolt, (1) 8mm Lock Washer and (1) 8mm Flat Washer, (**Figures 15 & 16**). Leave loose at this time.
  - b. **Models with flat tab and hole:** Insert the 8mm Bolt Plate down through the hole in the Upper Bracket and mounting tab, (**Figures 13 & 14**). Attach the Lower Bracket to the bottom of the body and Bolt Plate with (1) 8mm Flat Washer and (1) 8mm Nylon Lock Nut, (**Figures 15 & 16**). Leave loose at this time.
10. Line up the side tab on the Lower Bracket with the threaded hole in the side of the Upper Bracket. Attach the Lower Bracket to the Upper Bracket with (1) 8mm x 25mm Hex Bolt, (1) 8mm Lock Washer and (1) 8mm Flat Washer, (**Figure 16**). Leave loose at this time.
11. Repeat **Steps 1—3** for the (3) remaining passenger side Bracket installations. **NOTE:** Cradles on Brackets installed on passenger side will face forward.
12. Repeat **Steps 5 & 6** to install the passenger Sidebar. (**Figure 17**).
13. Once the Sidebars are fully installed and all hardware fully tightened, reinstall the DEF tank and cover, if equipped, as described in **Step 7**.
14. Do periodic inspections to the installation to make sure that all hardware is secure and tight.



(Fig 15) Passenger/right Front Lower Bracket (all models)

All models use:  
 8mm x 25mm Hex Bolt  
 8mm Lock Washer  
 8mm Flat Washer

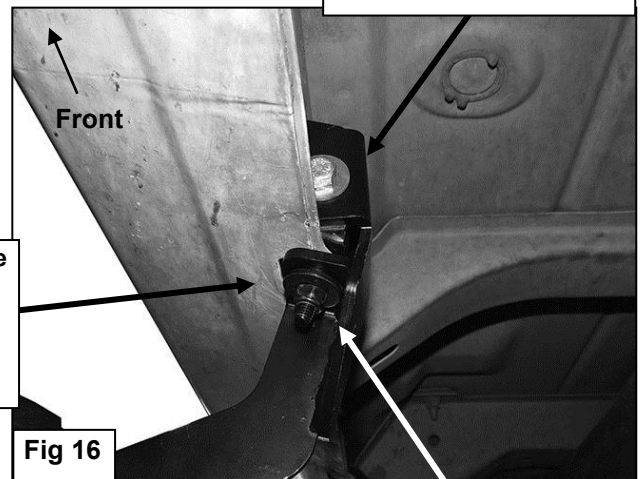
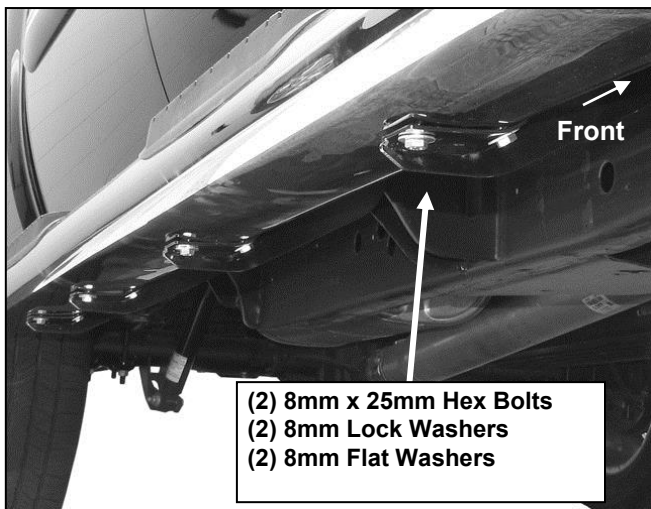

Fig 16

On models with flat tab and 8mm Bolt Plate (see Fig. 14) use:  
 8mm Flat Washer  
 8mm Nylon Lock Nut  
 to attach Lower Bracket to Bolt Plate

Models with weld nut on tab use:  
 8mm x 25mm Hex Bolt  
 8mm Lock Washer  
 8mm Flat Washer  
 to bolt Lower Bracket to weld nut



(2) 8mm x 25mm Hex Bolts  
 (2) 8mm Lock Washers  
 (2) 8mm Flat Washers

(Fig 17) Passenger side installation pictured



Complete Installation

## PARTS IDENTIFICATION GUIDE

**Driver Side tube packed using "Green" color foam sheet. Passenger Side tube packed using "White" color foam sheet**

| No. | Parts Identification                           |
|-----|--|
| 1   | Passenger / Right 'Rear' Bracket marked "PR"   |
| 2   | Driver / Left 'Rear' Bracket marked "DR"       |
| 3   | Passenger / Right 'Center' Bracket marked "PC" |
| 4   | Driver / Left 'Center' Bracket marked "DC"     |
| 5   | Passenger / Right 'Front' Bracket marked "PF"  |
| 6   | Driver / Left 'Front' Bracket marked "DF"      |

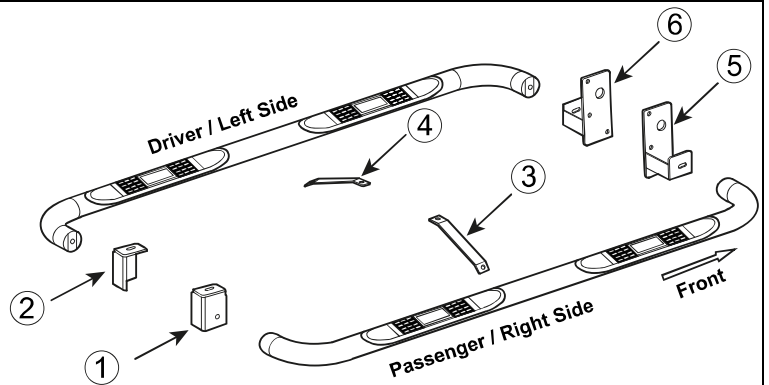

### Note:

- This guide is to identify the parts and not a reference for part count.
- For part count, refer Parts List.
- Product / Bracket image is representative and actual design may vary.

## PRODUCT CARE

- Periodically check the product to ensure all fasteners are tight and components are intact.
- Regular waxing is recommended to protect the finish of the product.
- **Use ONLY Non-Abrasive automotive wax.** Use of any soap, polish or wax that contains an abrasive is detrimental and can scratch the finish leading to corrosion.
- Aluminum polish may be used to polish small scratches and scuffs for **Stainless Steel finish.**
- Mild soap may be used to clean the product for both **Stainless Steel and Black finish.**

## FAQ's

### 1. Hardware's are not of correct size.

*In GMC / Chevrolet truck model 2006 & up, customer needs to reuse the factory body bolts to install the bracket. If your vehicle is not GMC / Chevrolet 2006 & up, ensure that holes are not partially covered with any plastic grommet or rust? If it is, remove the plastic grommet & rust from the thread holes & re-try the installation.*

### 2. Mounting Bracket are not getting Installed properly.

*In some cases Illustration images shown in Installation manual may not be the exactly same as per actual vehicle images ,also if Driver / Passenger side mounting brackets are very identical in the design, suggest referring Parts Identification guide to avoid fitment issue.*

### 3. Products are thumping / rattling after installation.

*Ensure that all required mounting brackets / hardware's are installed & tighten correctly. Suggest using white lithium / regular grease between the metal to metal contact surfaces.*

### 4. Side Bar is not aligning with vehicle / Step Pads are not aligning with vehicle doors.

*Side bar may be interchanged or mounting brackets are not installed at the correct position in the vehicle. Refer Parts identification guide.*

### 5. Missing / Excess Hardware.

*Recheck hardware count as per the part list.*

### 6. Product not installing properly.

*Ensure make model year, cab length and bed size of your vehicle is listed in the application. All installation steps are followed correctly.*