

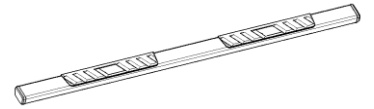

# 4" Side Bar

## Part No. A4002S/B



Fits: 2007 - Current

Chevrolet Silverado /GMC Sierra 1500/2500/3500  
Crew Cab (Rocker Panel Mount)



INCLUDING DIESEL MODELS WITH DEF TANKS



REMOVE CONTENTS FROM BOX. VERIFY ALL PARTS ARE PRESENT.



READ INSTRUCTIONS CAREFULLY BEFORE STARTING INSTALLATION.

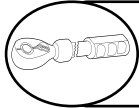

DO NOT OVER TORQUE. STANDARD OPERATING LOAD FOR TIGHTEN BODY MOUNT NUTS & BOLTS VARIES FROM 45 TO 65 FOOT POUND.



60-180 min



Cutting Required



Drilling Not Required

### PARTS LIST:

Qty	Part Description	Qty	Part Description
1	Driver/left Side Step	11	8-1.25mm Clip-On Nuts
1	Passenger/right Side Step	13	8-1.25mm x 25mm Hex Bolts
1	Passenger/right Front Upper Bracket (all incl. DEF)	13	8mm x 24mm x 2mm Flat Washers
1	Passenger/right Front Lower Bracket (all incl. DEF)	13	8mm Lock Washers
5	4" Sidebar Brackets (use for left or right)	1	8mm Bolt Plate
6	Plastic Bracket Covers	1	8mm Nylon Lock Nut (use w-bolt plate)
12	Retaining Clips (Plastic Covers)	12	8mm x 25mm Combination Bolts

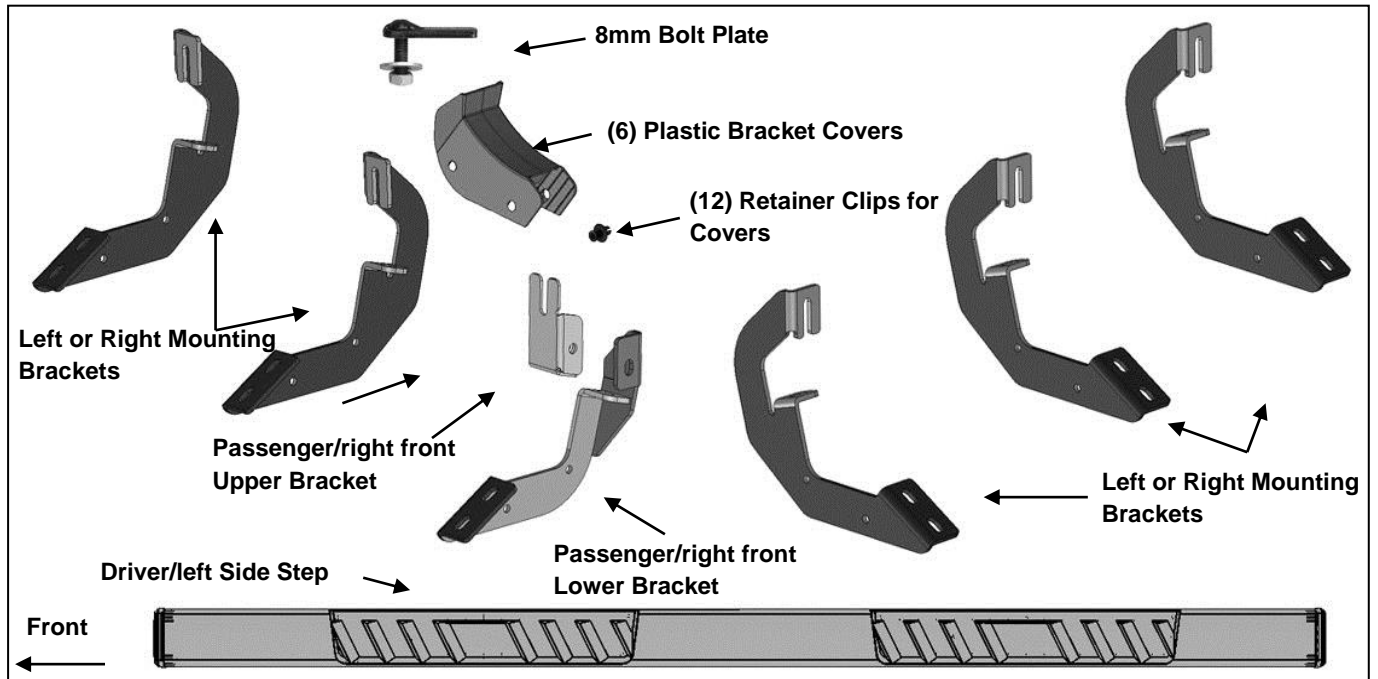

## INSTALLATION PROCEDURE:

**ON MODELS WITH DEF TANK, SELECT A FLAT, LEVEL AREA FOR INSTALLATION. MAY REQUIRE CUTTING.**

1. Start the installation under the driver side of the vehicle. Locate the 5 tabs along the bottom edge of the body, (pinch weld). Mounting Brackets will bolt to the 1st, 2nd, (just in front of center of cab), and 5th mounting tabs, **(Figure 1)**. Directly above each tab is a top mounting location on the side of the body panel. Hold a Bracket up in place to help determine the mounting holes to use along the body.

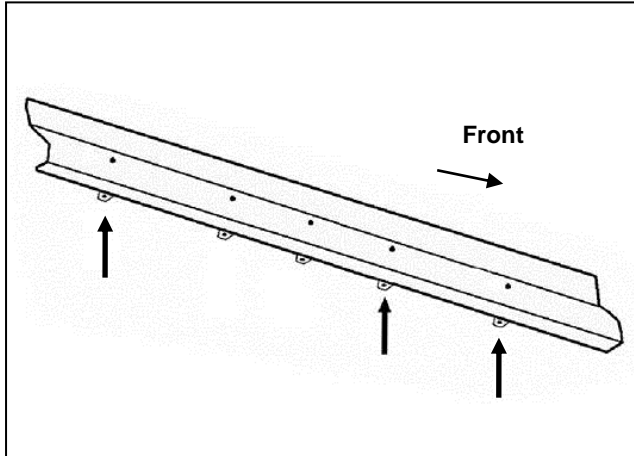

**(Fig 1) Back of driver side (3) mounting locations**

2. Determine the correct procedure for your model year and each Bracket location.

**Bottom mounting location on the edge of the pinch weld.**

**Flat tab on pinch weld with factory installed weld nut:**

Thread hex bolt into weld nut from the backside-down to clear paint from threads, **(Figure 2)**.

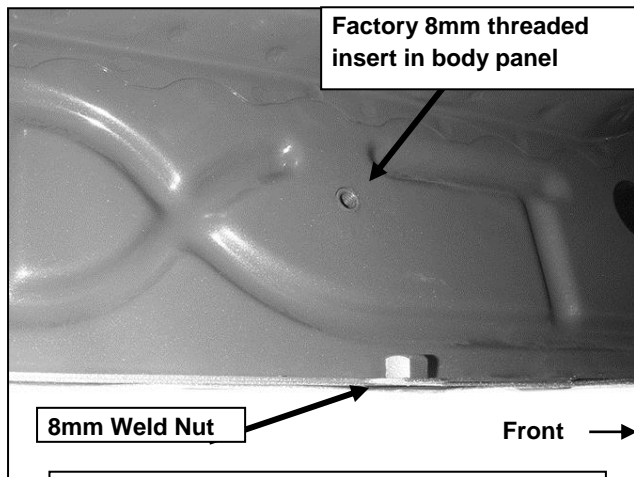

**(Fig 2) Driver side front mounting location**

**Flat tab on pinch weld with hole:**

Select (1) 8mm Clip Nut. Slide the Clip Nut over the tab with the nut facing up behind the tab, **(Figures 3—5)**. Line up threaded nut with hole in tab. Repeat for each mounting location.

Factory 8mm threaded insert in body panel

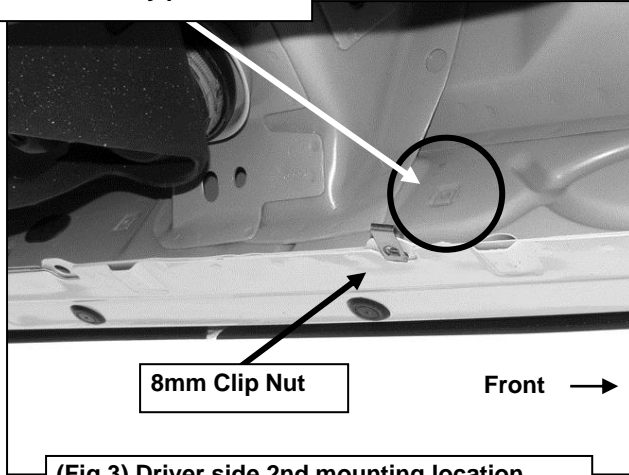

(Fig 3) Driver side 2nd mounting location

Remove plug

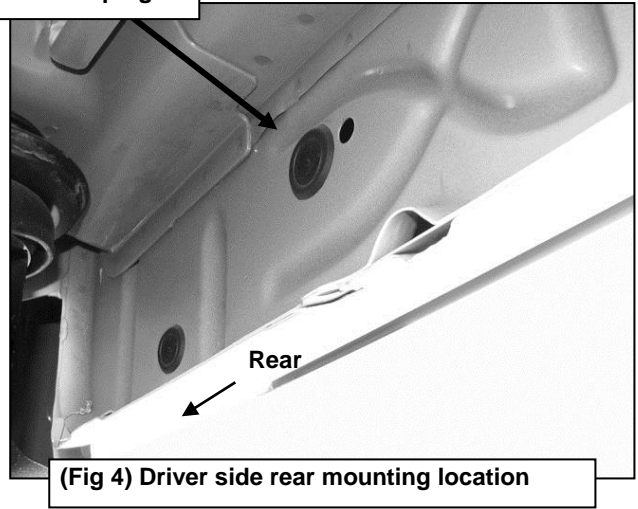

(Fig 4) Driver side rear mounting location

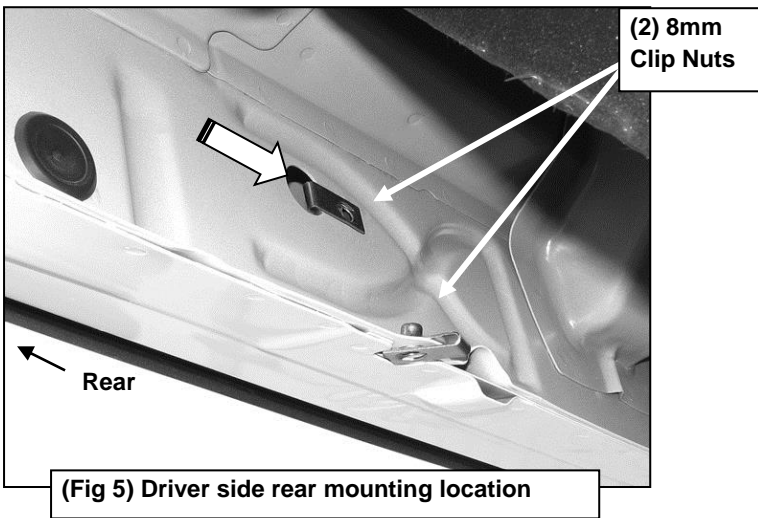

(Fig 5) Driver side rear mounting location

**Top mounting location on the side of the body panel.**

**Models with factory installed threaded insert in body panel:**

Thread 8mm Hex Bolt into threaded insert to clear paint as required, (Figures 2 & 3).

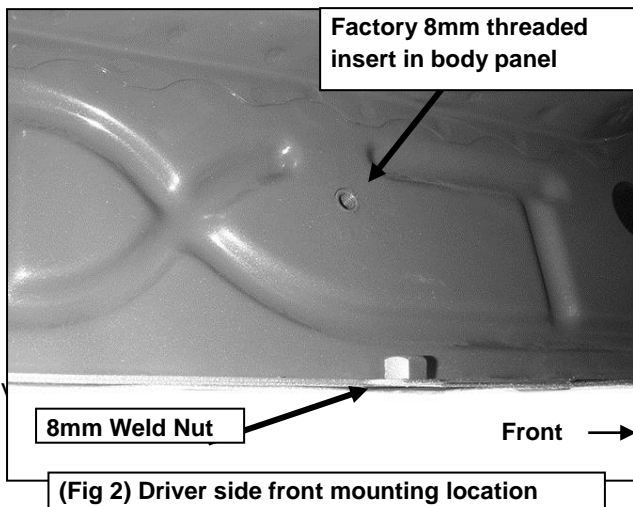

(Fig 2) Driver side front mounting location

Factory 8mm threaded insert in body panel

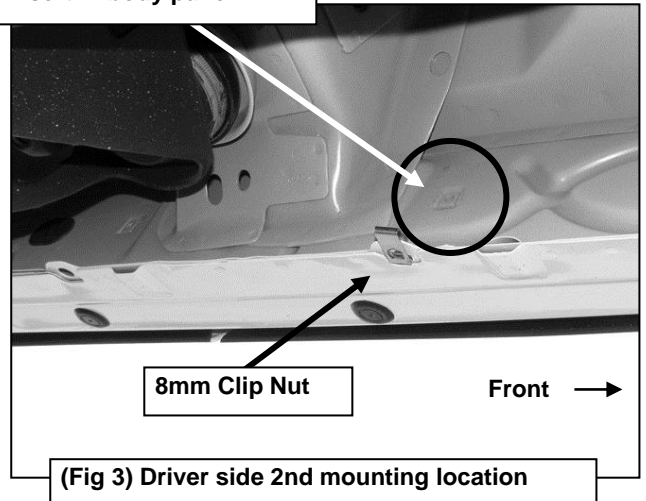

(Fig 3) Driver side 2nd mounting location

**Large and small hole in side of body panel:**

Remove the rubber plug from the larger hole, (Figure 4). Select (1) 8mm Clip Nut. Slide the Clip Nut into the larger hole. Line up the threaded nut with the smaller hole, (Figure 5).

Remove plug

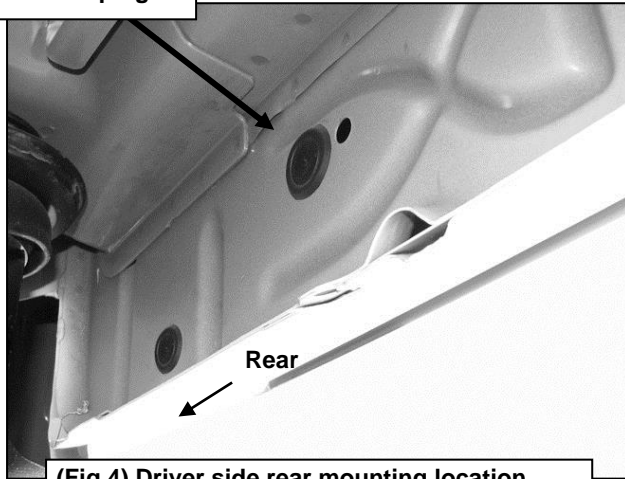

(Fig 4) Driver side rear mounting location

(2) 8mm  
Clip Nuts

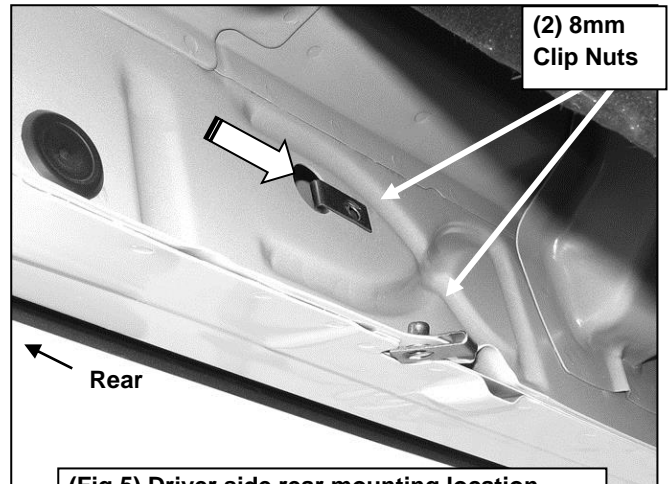

(Fig 5) Driver side rear mounting location

3. Select (1) Mounting Bracket. **NOTE:** (5) Brackets are universal and will fit all left side and center and rear only on right side of vehicle. Bolt the Mounting Bracket to the Clip Nuts and/or the factory threaded holes with (2) 8mm Hex Bolts, (2) 8mm Lock Washers and (2) 8mm Flat Washers, (Figures 6 & 7). Snug but do not fully tighten the hardware.

(2) 8mm x 25mm Hex Bolts  
(2) 8mm Lock Washers  
(2) 8mm Flat Washers

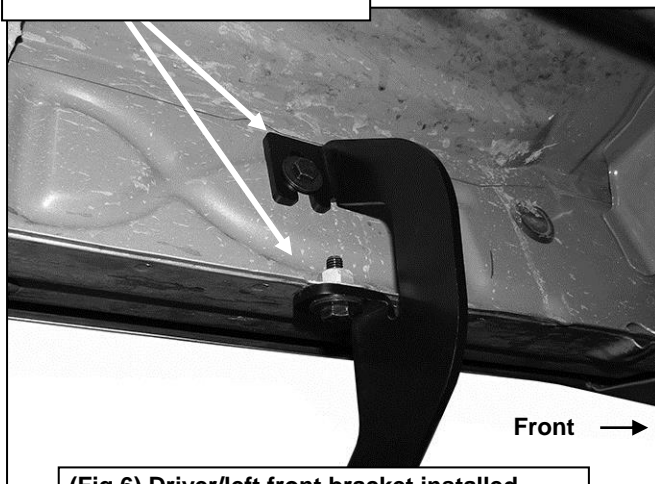

(Fig 6) Driver/left front bracket installed

(2) 8mm x 25mm Hex Bolts  
(2) 8mm Lock Washers  
(2) 8mm Flat Washers

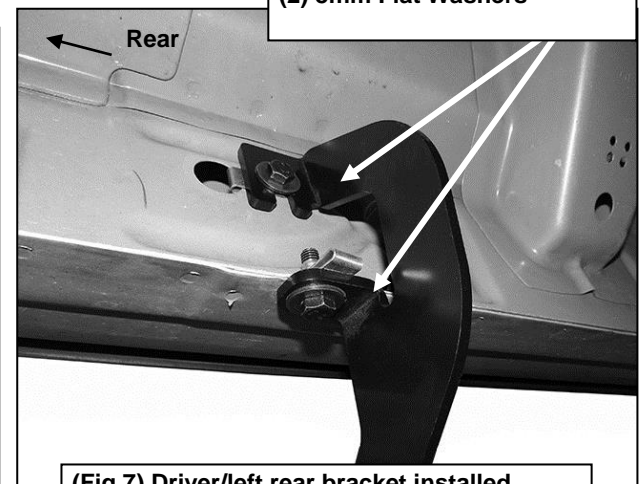

(Fig 7) Driver/left rear bracket installed

4. Repeat Steps 1—3 to install the center and rear driver side Brackets, (Figures 1 & 7).

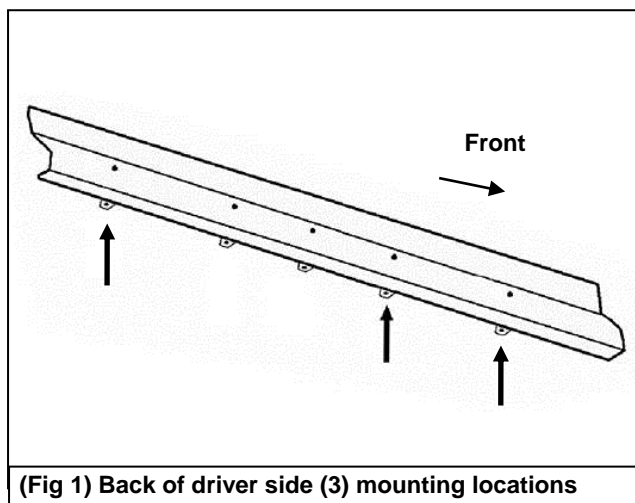

(Fig 1) Back of driver side (3) mounting locations

(2) 8mm x 25mm Hex Bolts  
(2) 8mm Lock Washers  
(2) 8mm Flat Washers

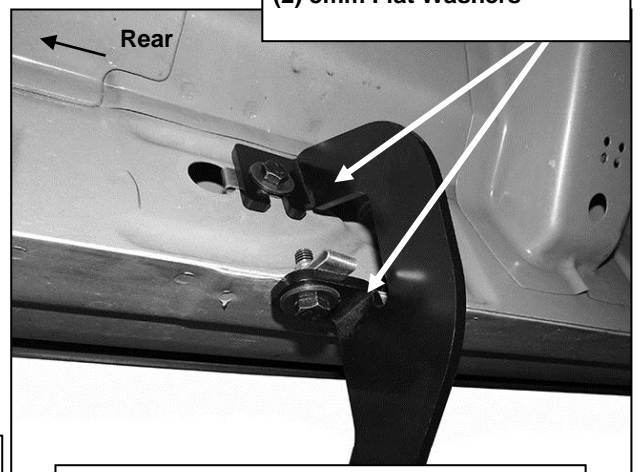

(Fig 7) Driver/left rear bracket installed

5. Select (1) Plastic Bracket Cover and (2) Retaining Clips. Slide the Cover over the driver side front Bracket. Line up the (2) mounting holes in the Cover with the holes in the Bracket. Insert the Clip into the holes and push center pin to expand Clip, **(Figure 8)**. Repeat this Step for all Cover installation.

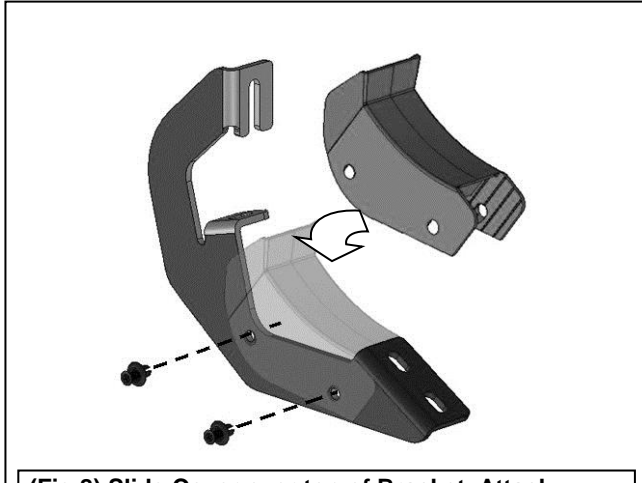

**(Fig 8) Slide Cover over top of Bracket. Attach Cover to Bracket with (2) Retaining Clips**

6. Select the driver/left Side Step. Carefully position the Driver Side Step onto the (3) Mounting Brackets. **IMPORTANT:** Do not slide the Side Step on the Brackets or damage to the finish may result. Attach the Side Step to the Mounting Brackets with (6) 8mm x 25mm Combination Hex Bolts, **(Figure 9)**. Do not tighten hardware.

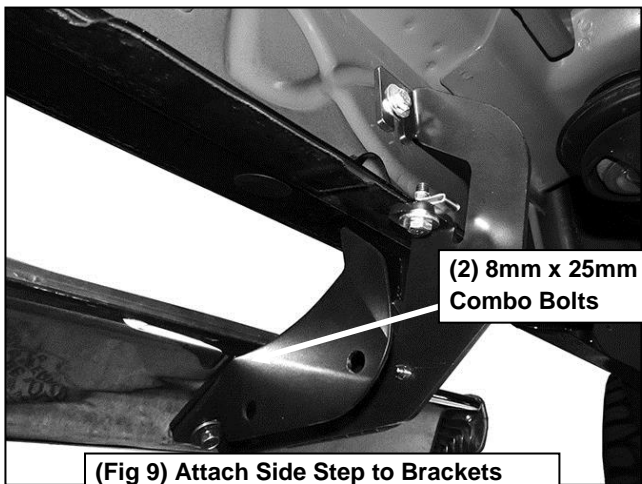

**(Fig 9) Attach Side Step to Brackets**

7. Level and adjust the Side Step and fully tighten all hardware.
8. Move to the passenger side of the vehicle. On the passenger side, determine if the vehicle is equipped with a plastic diesel exhaust fluid (DEF) tank, **(Figures 10 & 11)**.

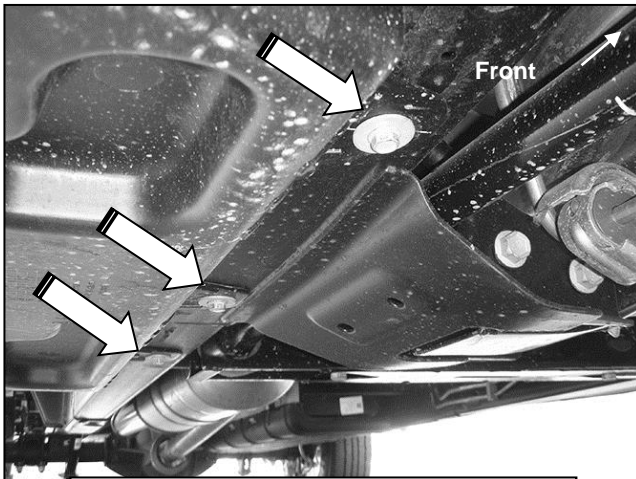

**(Fig 10) 07-16 Passenger side front pictured with DEF tank cover. Remove (3) hex bolts to remove cover**

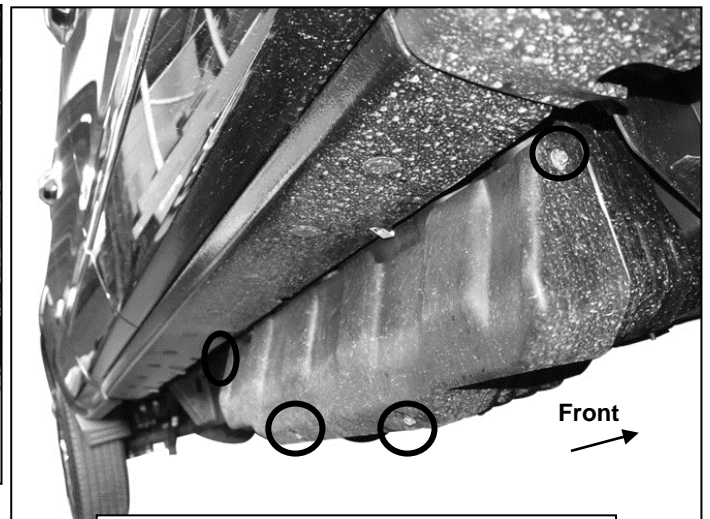

**(Fig 11A) 2017 Passenger side pictured with DEF plastic tank cover. Remove (4) hex bolts to remove plastic cover**



(Fig 11B) 2017 Passenger side DEF cover

**Models without DEF tank, skip to Step 9.**

**Models with DEF tank:** The tank sits close to the side of the body. With specialized tools, the passenger front upper and lower Bracket can be installed but room is limited. It may be easier to drop the tank down to access the inner side of the body panel for upper bracket installation. Tank will not need to be removed, only dropped down for access to mounting location. **IMPORTANT:** If tank is full, it will be very heavy and assistance is highly recommended to avoid injury or damage to the vehicle or the tank. It is recommended that installation is performed when the DEF tank is low on fluid before dropping the tank.

- a. On models with plastic lower tray under tank, remove the (3) hex bolts attaching the tray to the frame, (**Figure 10**), and remove tray. **2017 2500/3500 models:** Remove the (4) hex bolts attaching the plastic cover to DEF tank, (**Figure 11A**) and remove plastic cover, (**Figure 11B**).

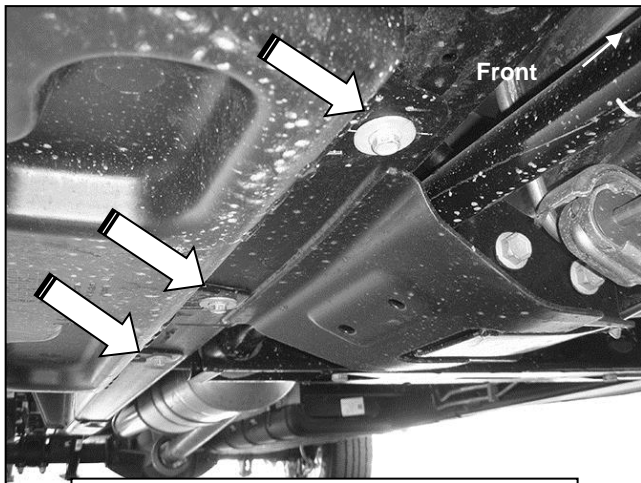

(Fig 10) 07-16 Passenger side front pictured with DEF tank cover. Remove (3) hex bolts to remove cover

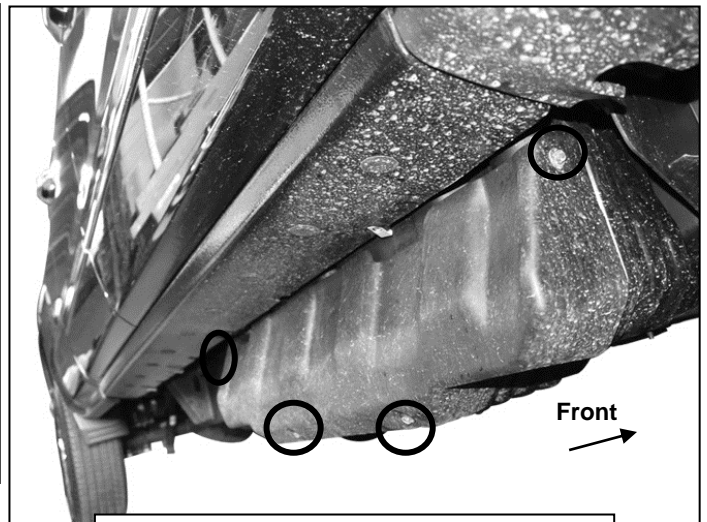

(Fig 11A) 2017 Passenger side pictured with DEF plastic tank cover. Remove (4) hex bolts to remove plastic cover

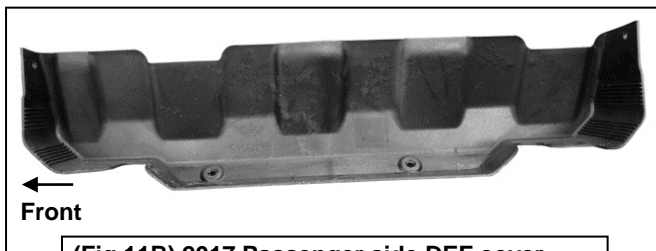

(Fig 11B) 2017 Passenger side DEF cover

- b. Release the tank filler hose. Release the plug for the sending unit on the top of the tank.
- c. Support the tank with a floor jack. Place a smooth flat surface, (wooden block for example), between the floor jack and the tank to avoid damaging the plastic tank. Do not push up on the tank; only support the weight of the tank with the jack.
- d. Remove the (2) bolts securing the tank straps to the vehicle, (**Figure 12**). Tilt the straps to release from the brackets. Slowly lower the tank until the top of the tank is almost visible. Use blocks or stands to support the tank while installing the front Upper and Lower Brackets.



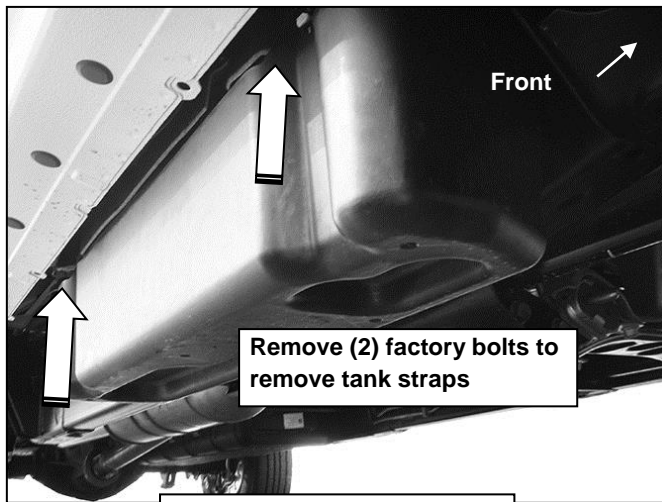

Remove (2) factory bolts to remove tank straps

(Fig 12) 07-16 Passenger side DEF tank and cover

e. Proceed to Step 9.

9. Locate the first tab on the edge of the pinch weld on the passenger side, (Figures 2—4, 14 & 16). Select the Upper Bracket, (Figure 13). Repeat Steps 2 & 3 to attach the passenger front Upper Bracket to the side of the body panel, (Figure 14). Do not tighten hardware at this time.

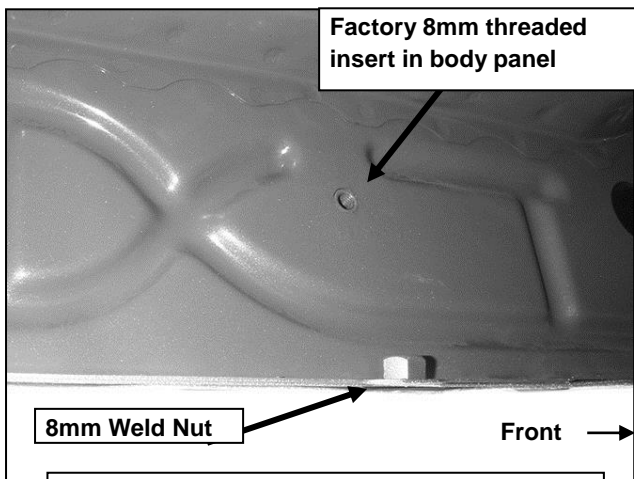

(Fig 2) Driver side front mounting location

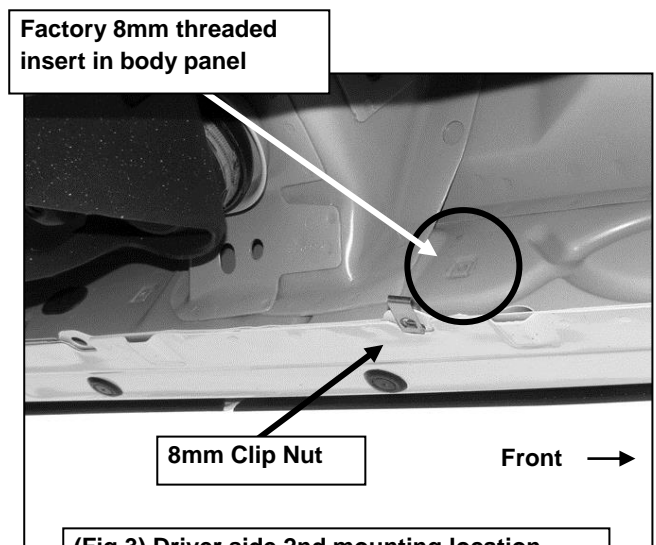

(Fig 3) Driver side 2nd mounting location

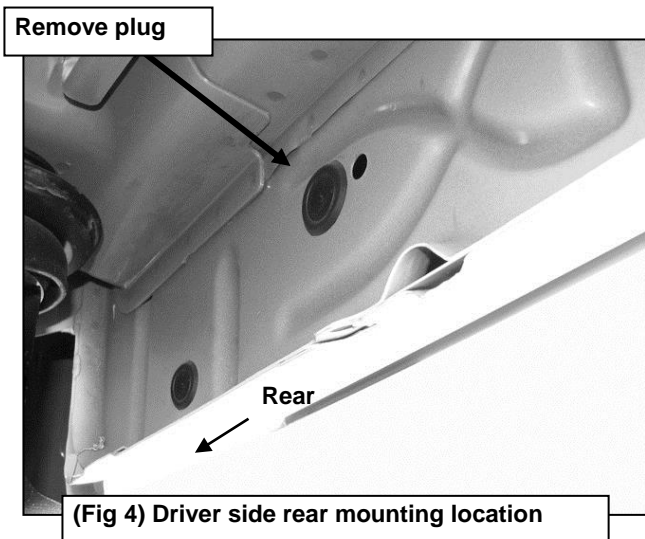

(Fig 4) Driver side rear mounting location

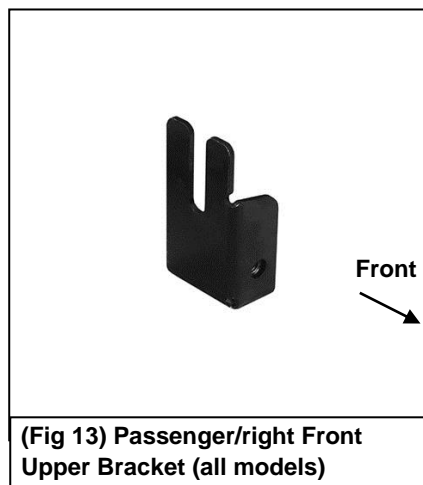

(Fig 13) Passenger/right Front Upper Bracket (all models)

8mm x 25mm Hex Bolt  
8mm Lock Washer  
8mm Flat Washer

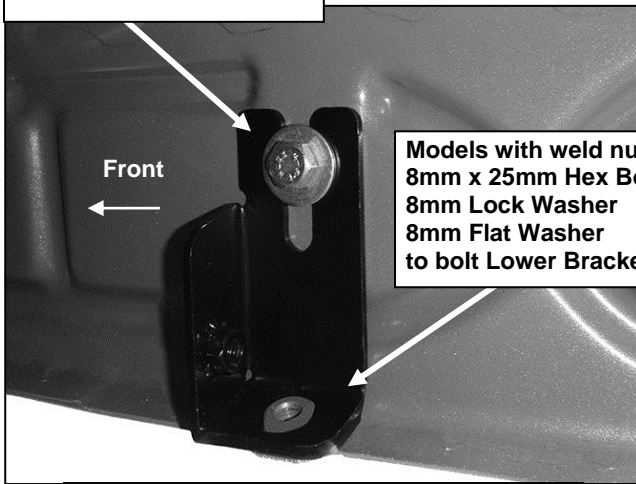

Models with weld nut on tab use:  
8mm x 25mm Hex Bolt  
8mm Lock Washer  
8mm Flat Washer  
to bolt Lower Bracket to weld nut

(Fig 14) Slide Upper Bracket over weld nut  
if equipped-also see Figure 2

On models with flat tab (see Fig 3 and 4), insert  
8mm Bolt Plate (Fig 15) down through Upper  
Bracket and mounting tab

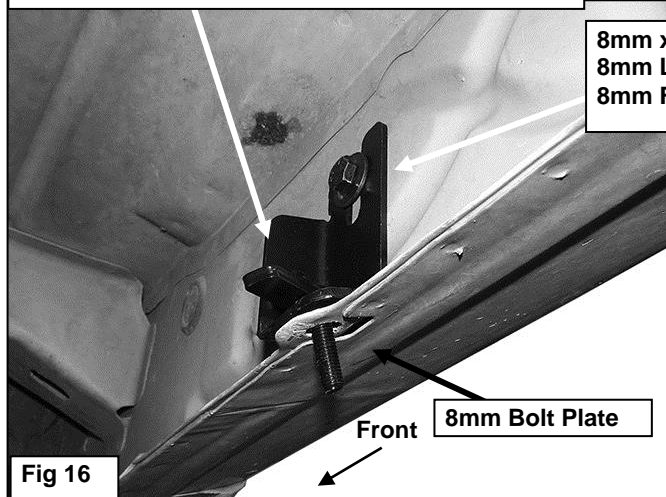

8mm x 25mm Hex Bolt  
8mm Lock Washer  
8mm Flat Washer

8mm Bolt Plate

Fig 16

10. Line up the hole in the bottom of the Upper Bracket with the hole in the tab on the pinch weld.
  - a. **Models with a weld-nut:** Slide the Bracket over the weld-nut, (**Figure 14**). Attach the Lower Bracket to the bottom of the body and weld-nut with (1) 8mm x 25mm Hex Bolt, (1) 8mm Lock Washer and (1) 8mm Flat Washer, (**Figures 14 & 21**). Leave loose at this time.

8mm x 25mm Hex Bolt  
8mm Lock Washer  
8mm Flat Washer

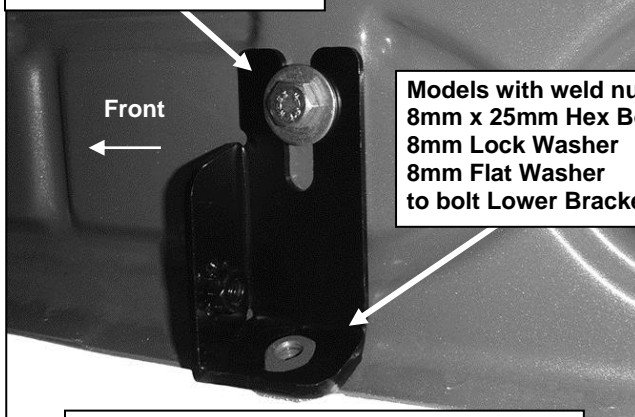

Models with weld nut on tab use:  
8mm x 25mm Hex Bolt  
8mm Lock Washer  
8mm Flat Washer  
to bolt Lower Bracket to weld nut

(Fig 14) Slide Upper Bracket over weld nut  
if equipped-also see Figure 2



Models with weld nut on tab use:  
 8mm x 25mm Hex Bolt  
 8mm Lock Washer  
 8mm Flat Washer  
 to attach Lower Bracket to weld nut

All models use:  
 8mm x 25mm Hex Bolt  
 8mm Lock Washer  
 8mm Flat Washer

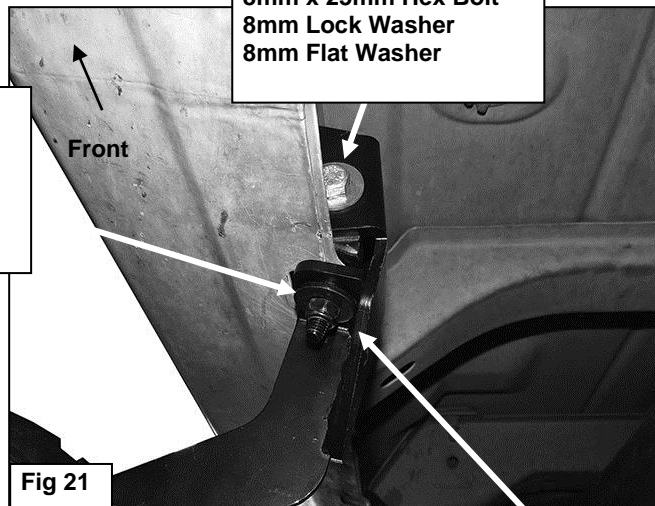

Fig 21

On models with flat tab and 8mm Bolt Plate (see Fig. 16) use:  
 8mm Flat Washer  
 8mm Nylon Lock Nut  
 to attach Lower Bracket to Bolt Plate

- b. **Models with flat tab and hole:** Insert the 8mm Bolt Plate down through the hole in the Upper Bracket and mounting tab, (Figures 15 & 16). Attach the Lower Bracket to the bottom of the body and Bolt Plate with (1) 8mm Flat Washer and (1) 8mm Nylon Lock Nut, (Figure 21). Leave loose at this time.



(Fig 15) 8mm x 35mm Bolt Plate

On models with flat tab (see Fig 3 and 4), insert 8mm Bolt Plate (Fig 15) down through Upper Bracket and mounting tab

8mm x 25mm Hex Bolt  
 8mm Lock Washer  
 8mm Flat Washer

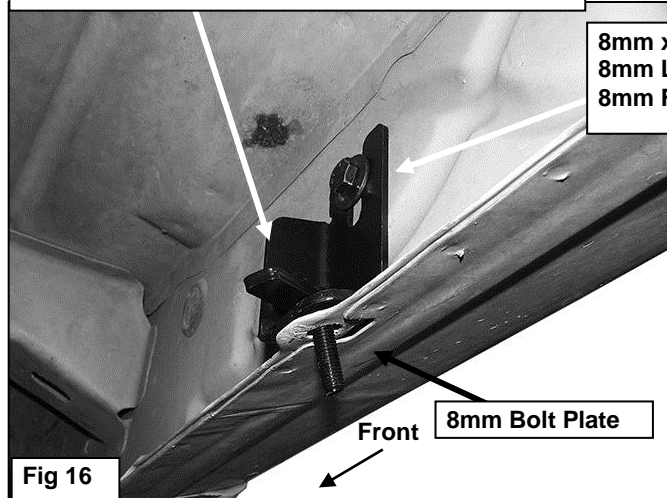

Fig 16

11. Line up the side tab on the Lower Bracket with the threaded hole in the side of the Upper Bracket. Attach the Lower Bracket to the Upper Bracket with (1) 8mm x 25mm Hex Bolt, (1) 8mm Lock Washer and (1) 8mm Flat Washer, (Figures 16 & 17). Leave loose at this time.

On models with flat tab (see Fig 3 and 4), insert 8mm Bolt Plate (Fig 15) down through Upper Bracket and mounting tab

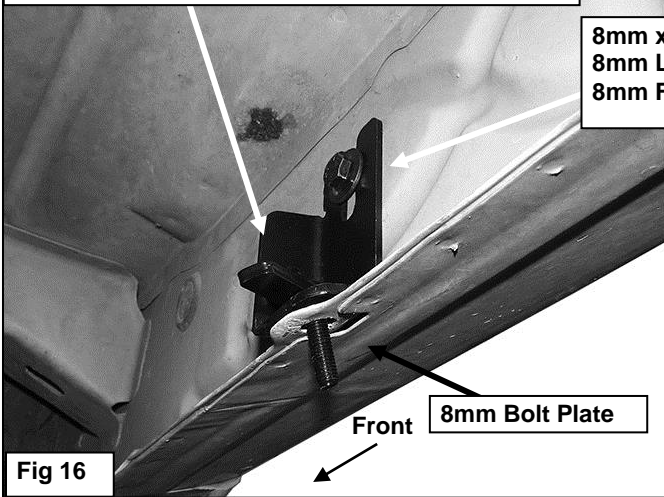
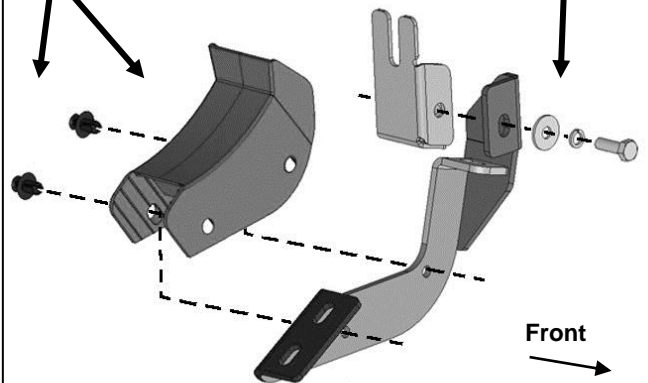

Fig 16

8mm x 25mm Hex Bolt  
8mm Lock Washer  
8mm Flat Washer

Bracket Cover  
(2) Plastic Retainers

8mm x 25mm Hex Bolt  
8mm Lock Washer  
8mm Flat Washer



(Fig 17) Passenger/right Front Upper and Lower Bracket (all models) and Bracket Cover

12. Repeat **Steps 1—3** for the (2) remaining passenger side Bracket installations. **NOTE:** Cradles on Brackets installed on passenger side will face forward.
  - a. **2017 2500/3500 DEF tank models:** Locate the 2nd tab bracket location along the bottom edge of the body, (pinch weld), (**Figure 18**). Hold the DEF cover in place and mark the 2nd Bracket location onto the cover, (**Figure 19**). Use a sharp knife or hacksaw blade to carefully cut a slot in the plastic cover to clear the 2nd Bracket, (**Figure 20**). Remove as little plastic as possible.

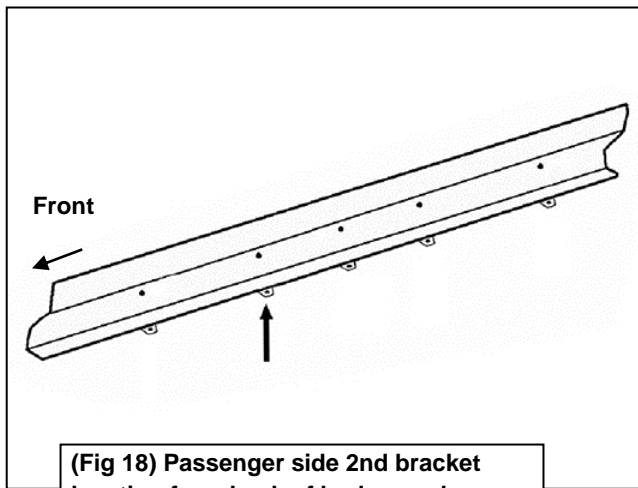

(Fig 18) Passenger side 2nd bracket location from back of body panel

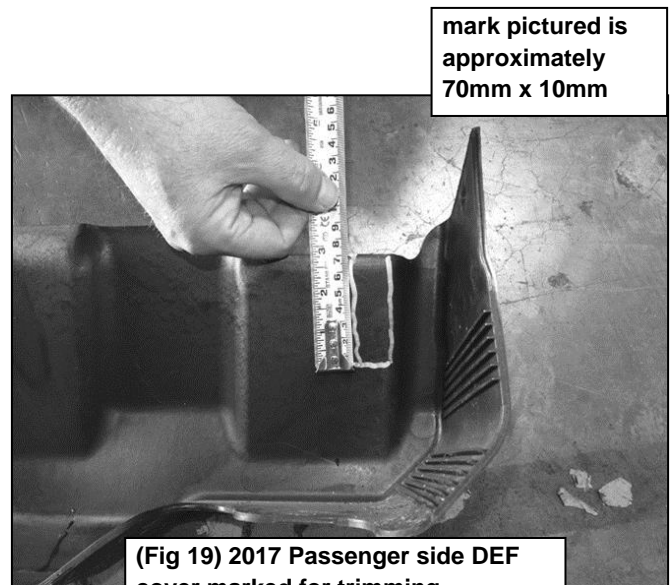

(Fig 19) 2017 Passenger side DEF cover marked for trimming

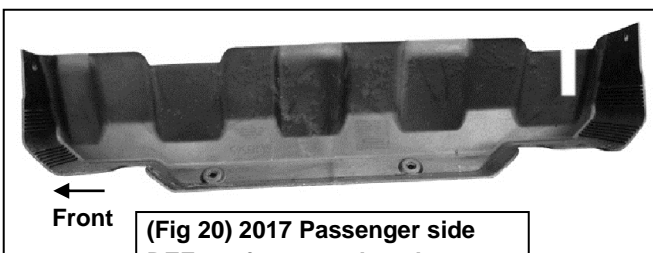

(Fig 20) 2017 Passenger side DEF cut for example only

13. Repeat **Steps 5—7** to install the passenger side Covers and Side Step, (**Figure 22**).

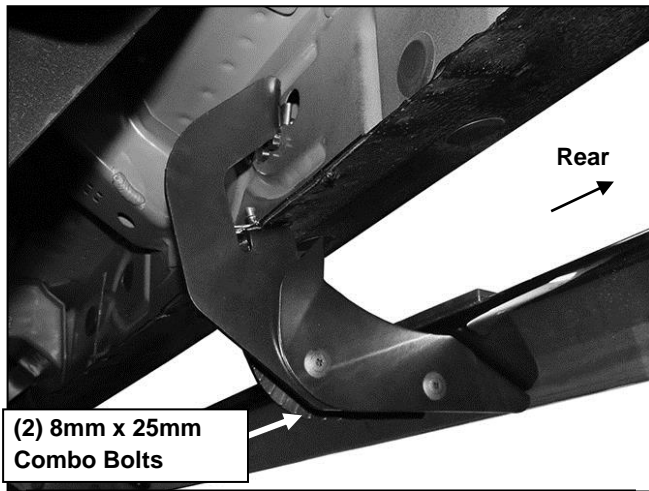

**(Fig 22) Passenger/right rear bracket installed**

14. Once the Side Steps are installed and all hardware fully tightened, reinstall the DEF tank and cover, if equipped, as described in **Step 8 & 12**.
15. Do periodic inspections to the installation to make sure that all hardware is secure and tight.

## PARTS IDENTIFICATION GUIDE

**Driver Side tube packed using "Green" color foam sheet. Passenger Side tube packed using "White" color foam sheet**

No.	Parts Identification
1	Passenger / Right 'Rear' Bracket marked "PR"
2	Driver / Left 'Rear' Bracket marked "DR"
3	Passenger / Right 'Center' Bracket marked "PC"
4	Driver / Left 'Center' Bracket marked "DC"
5	Passenger / Right 'Front' Bracket marked "PF"
6	Driver / Left 'Front' Bracket marked "DF"

**Note:**

- > This guide is to identify the parts and not a reference for part count.
- > For part count, refer Parts List.
- > Product / Bracket image is representative and actual design may vary.

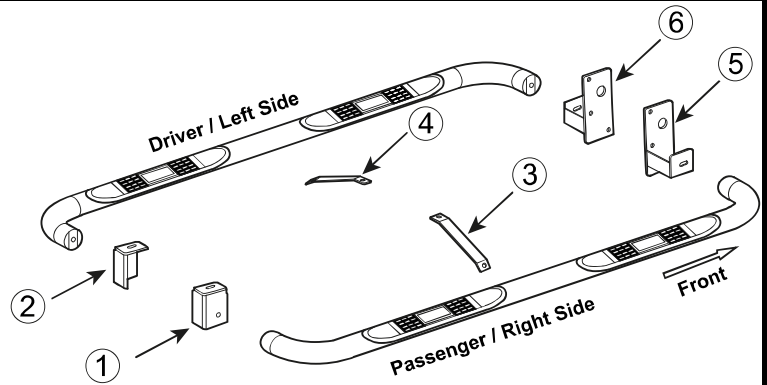

## PRODUCT CARE

- Periodically check the product to ensure all fasteners are tight and components are intact.
- Regular waxing is recommended to protect the finish of the product.
- **Use ONLY Non-Abrasive automotive wax.** Use of any soap, polish or wax that contains an abrasive is detrimental and can scratch the finish leading to corrosion.
- Aluminum polish may be used to polish small scratches and scuffs for **Stainless Steel finish.**
- Mild soap may be used to clean the product for both **Stainless Steel and Black finish.**

## FAQ's

### 1. Hardware's are not of correct size.

*In GMC / Chevrolet truck model 2006 & up, customer needs to reuse the factory body bolts to install the bracket. If your vehicle is not GMC / Chevrolet 2006 & up, ensure that holes are not partially covered with any plastic grommet or rust? If it is, remove the plastic grommet & rust from the thread holes & re-try the installation.*

### 2. Mounting Bracket are not getting Installed properly.

*In some cases Illustration images shown in Installation manual may not be the exactly same as per actual vehicle images ,also if Driver / Passenger side mounting brackets are very identical in the design, suggest referring Parts Identification guide to avoid fitment issue.*

### 3. Products are thumping / rattling after installation.

*Ensure that all required mounting brackets / hardware's are installed & tighten correctly. Suggest using white lithium / regular grease between the metal to metal contact surfaces.*

### 4. Side Bar is not aligning with vehicle / Step Pads are not aligning with vehicle doors.

*Side bar may be interchanged or mounting brackets are not installed at the correct position in the vehicle. Refer Parts identification guide.*

### 5. Missing / Excess Hardware.

*Recheck hardware count as per the part list.*

### 6. Product not installing properly.

*Ensure make model year, cab length and bed size of your vehicle is listed in the application. All installation steps are followed correctly.*

## Check out these other TrailFX Products!!

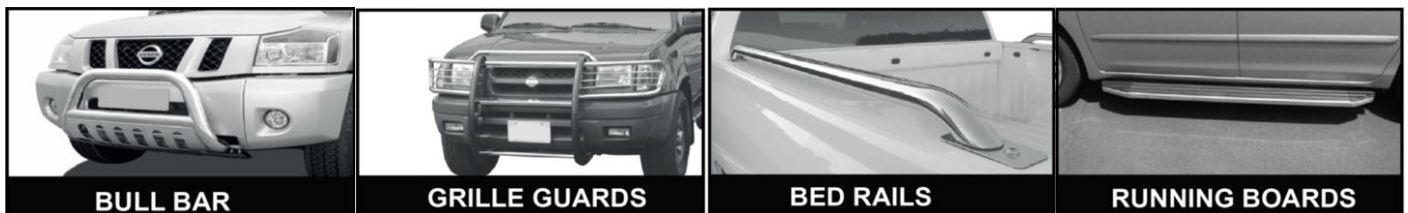

Keystone Automotive Operations Inc. (KAO) warrants this product to be free of defects in material and workmanship at the time of purchase by the original retail consumer. KAO disclaims any other warranties, express or implied, including the warranty of fitness for a particular purpose or an intended use. If the product is found to be defective, KAO may replace or repair the product at our option, when the product is returned prepaid, with proof of purchase. Alteration to, improper installation, or misuse of this product voids the warranty. KAO's liability is limited to repair or replacement of products found to be defective, and specifically excludes liability for any incidental or consequential loss or damage.