



3" Side Bar

Part No. A0059S /B



Fits: Current FORD RANGER SUPERCAB



60-180 min

Cutting Not Required

Drilling Not Required



REMOVE CONTENTS FROM BOX. VERIFY ALL PARTS ARE PRESENT.



READ INSTRUCTIONS CAREFULLY BEFORE STARTING INSTALLATION.

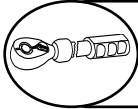

DO NOT OVER TORQUE. STANDARD OPERATING LOAD FOR TIGHTEN BODY MOUNT NUTS & BOLTS VARIES FROM 45 TO 65 FOOT POUND.

PARTS LIST:

Qty	Part Description	Qty	Part Description
1	Driver/Left Sidebar	12	10-1.5mm x 25mm Hex Bolts
1	Passenger/Right Sidebar	12	10mm Lock Washers
2	Front Mounting Brackets	12	10mm x 27mm x 3mm Flat Washers
4	Center/Rear Mounting Brackets	12	8-1.25mm x 25mm Combo Bolts

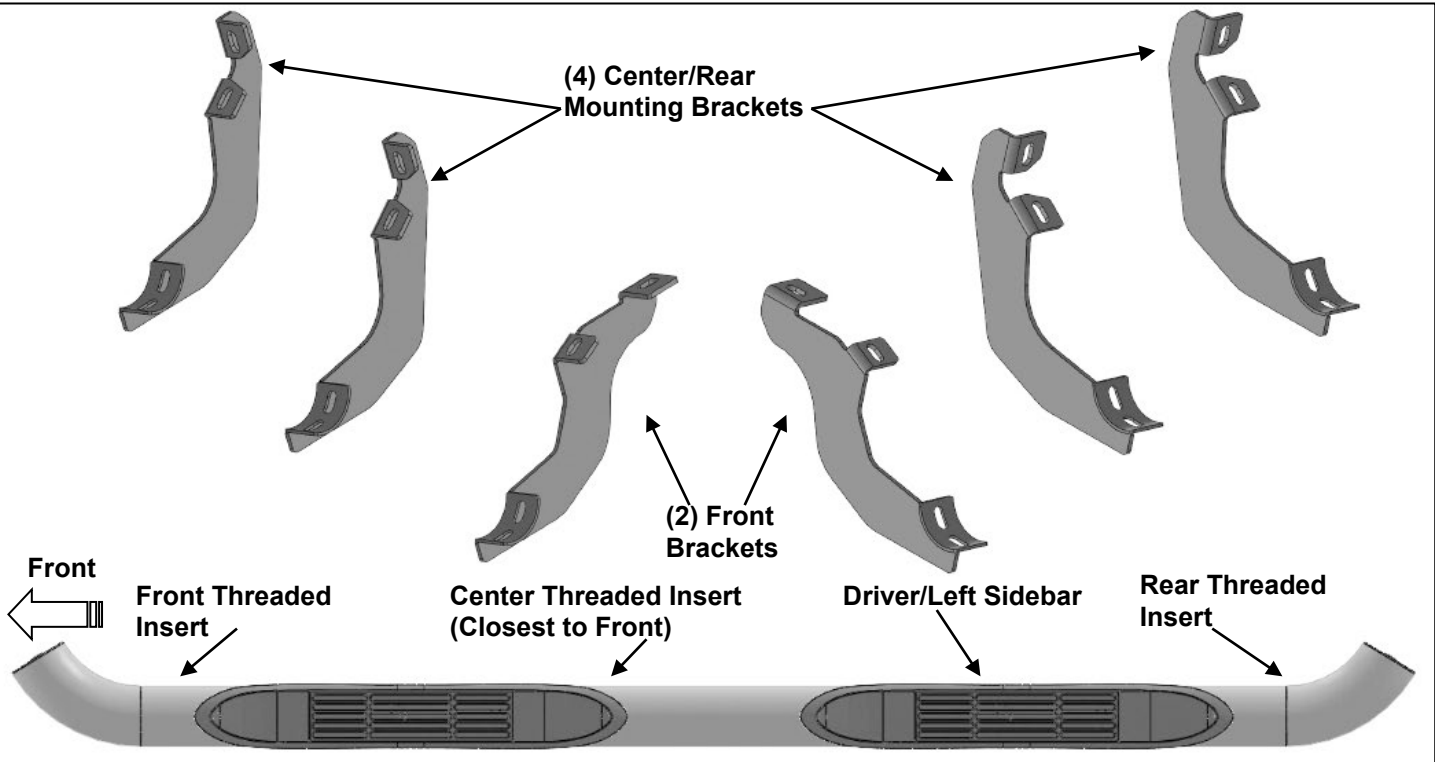

PROCEDURE:

1. REMOVE CONTENTS FROM BOX. VERIFY ALL PARTS ARE PRESENT. READ INSTRUCTIONS CAREFULLY BEFORE STARTING INSTALLATION.
2. Starting from underneath the Driver/Left side inner rocker panel, locate the threaded mounting holes on the rocker panel, (Figure 1). Remove the plastic plugs covering the mounting holes. Select the Passenger/Right Front Mounting Bracket, (Figure 2). Attach with (2) 10mm Hex Bolts, (2) 10mm Lock Washers and (2) 10mm Flat Washers, (Figures 2 & 3). Do not tighten hardware at this time.

3. Locate the Center threaded mounting holes. Select (1) Center/Rear Mounting Bracket. Attach with (2) 10mm Hex Bolts, (2) 10mm Lock Washers and (2) 10mm Flat Washers, (**Figures 4—6**). Do not tighten hardware at this time.
4. Repeat **Step 3** to install Rear Mounting Bracket, (**Figures 5, 7 & 8**).
5. Unwrap the Driver/Left Sidebar. Attach Sidebar to the mounting brackets with (6) 8mm Combo Bolts. Do not tighten hardware at this time, (**Figures 9—12**). **IMPORTANT:** Do not slide or rotate Sidebar on cradles, or damage to the finish may result.
6. Level and adjust Sidebar and tighten all hardware.
7. Repeat **Steps 2—6** for Passenger/Right side installation.
8. Do periodic inspections to the installation to make sure that all hardware is secure and tight.

To protect your investment, Do not use any type of polish or wax that may contain abrasives that could damage the finish. **For Stainless Steel**, Aluminum polish may be used to polish small scratches and scuffs on the finish. Mild soap may be used to clean the Sidebar.

Driver/Left side Installation Pictured

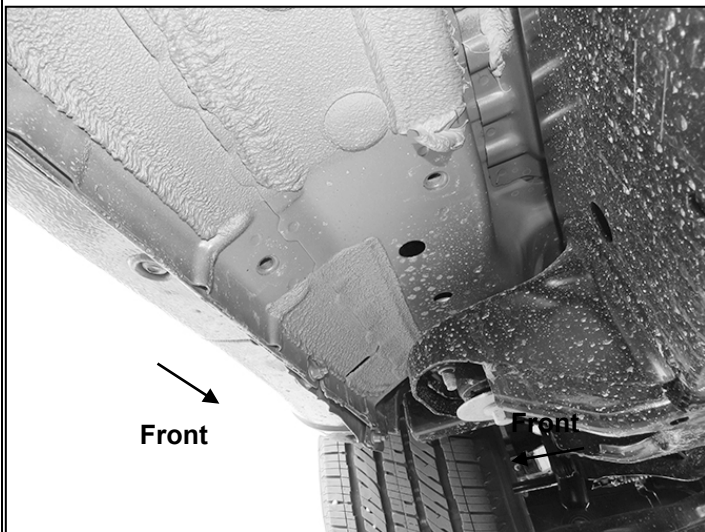

(Fig 1) Driver/Left Front mounting Location

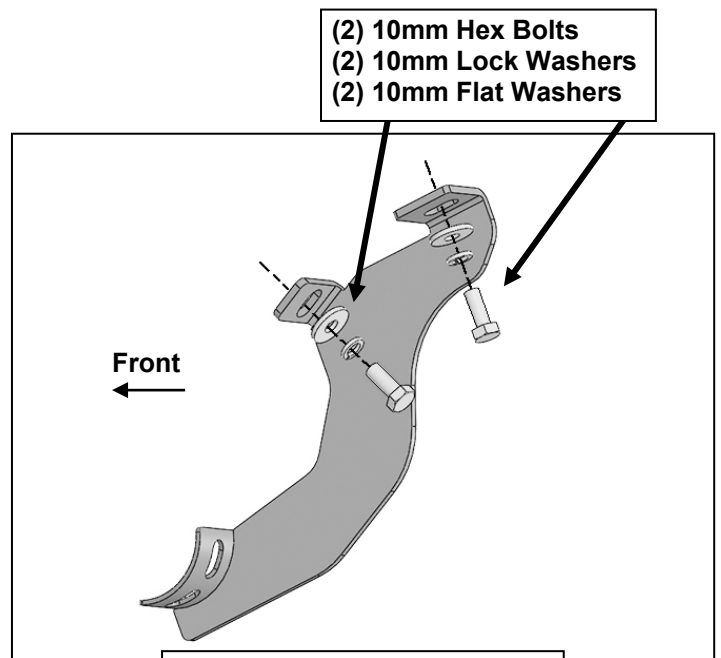

(Fig 2) Driver/Left Front Mounting Bracket installation

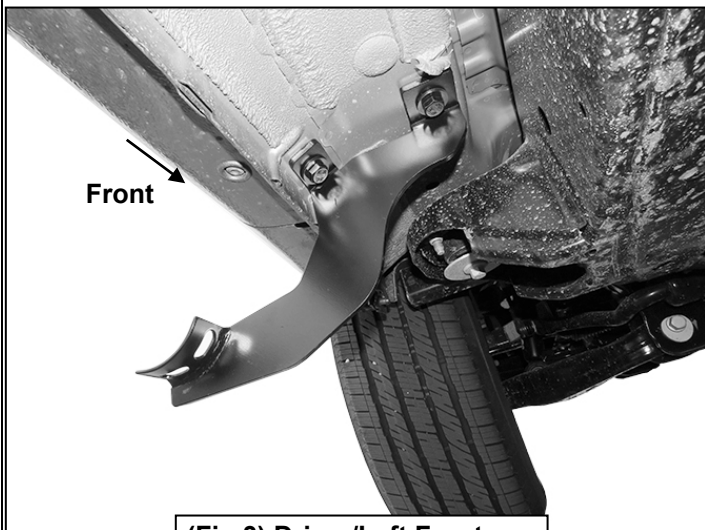

(Fig 3) Driver/Left Front Mounting Bracket attached

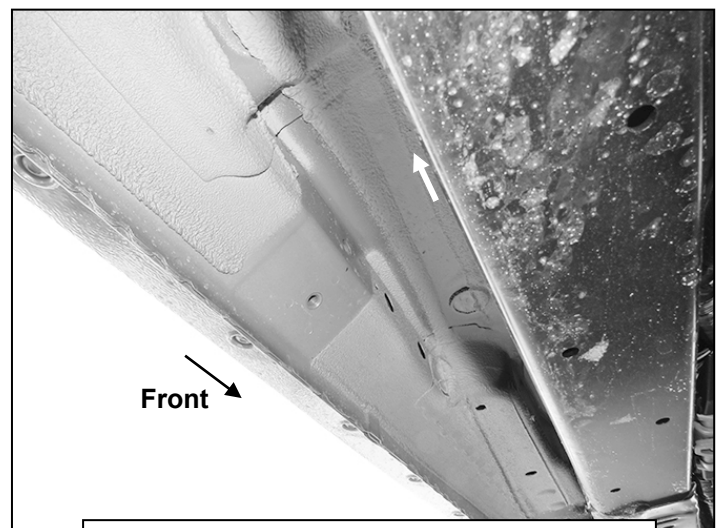

(Fig 4) Driver/Left Center mounting location

Driver/Left side Installation Pictured

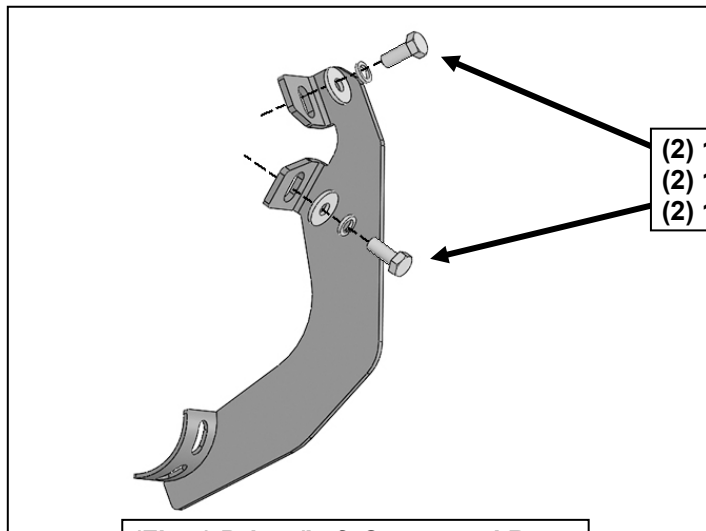

- (2) 10mm Hex Bolts
- (2) 10mm Lock Washers
- (2) 10mm Flat Washers

(Fig 5) Driver/Left Center and Rear mounting Bracket installation

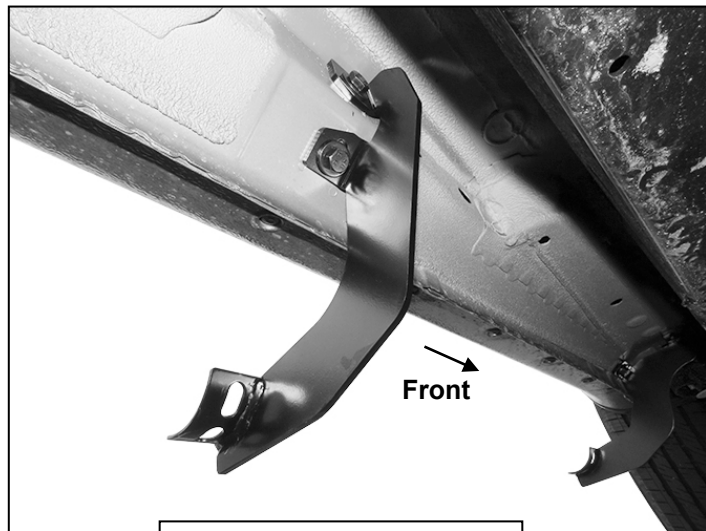

(Fig 6) Driver/Left Center Mounting Bracket installed

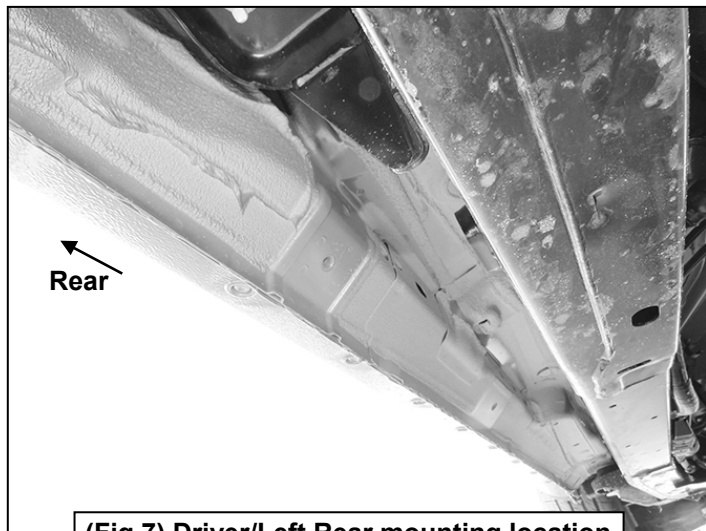

(Fig 7) Driver/Left Rear mounting location

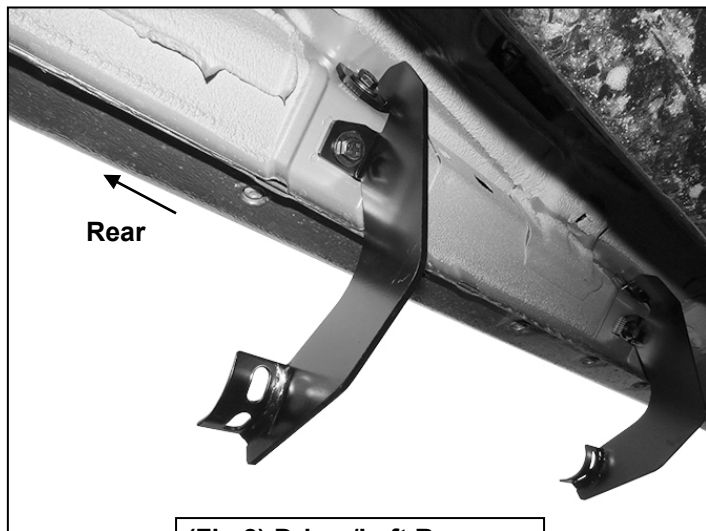

(Fig 8) Driver/Left Rear Mounting Bracket installed

Driver/Left side Installation pictured

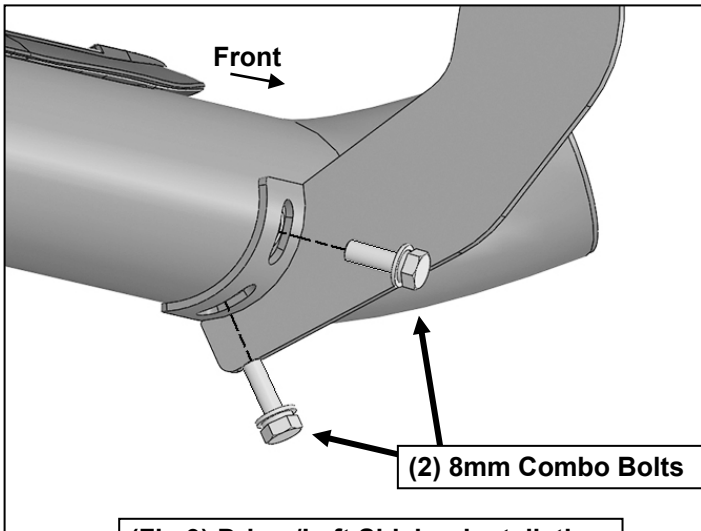

(Fig 9) Driver/Left Sidebar installation

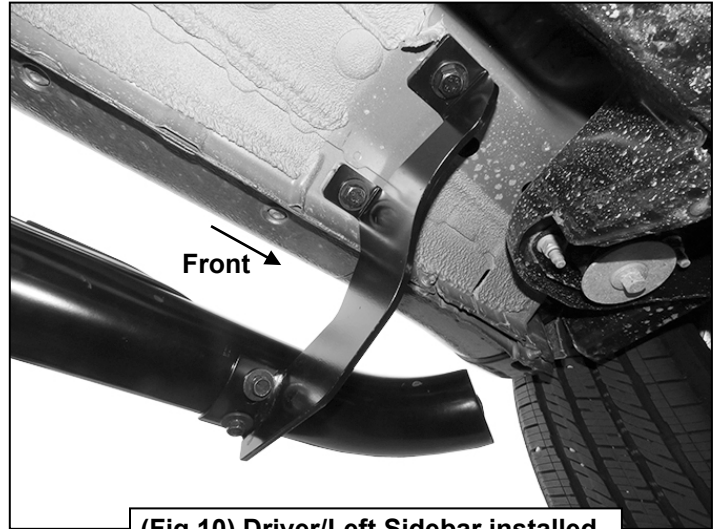

(Fig 10) Driver/Left Sidebar installed on Front Mounting Bracket

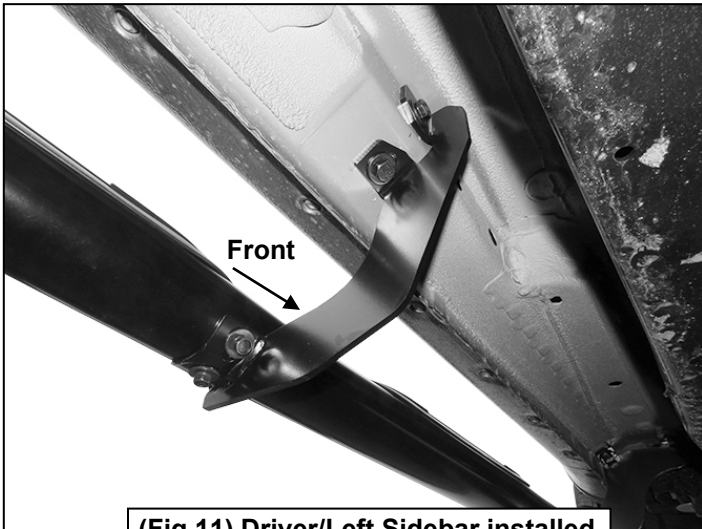

(Fig 11) Driver/Left Sidebar installed on Center Mounting Bracket

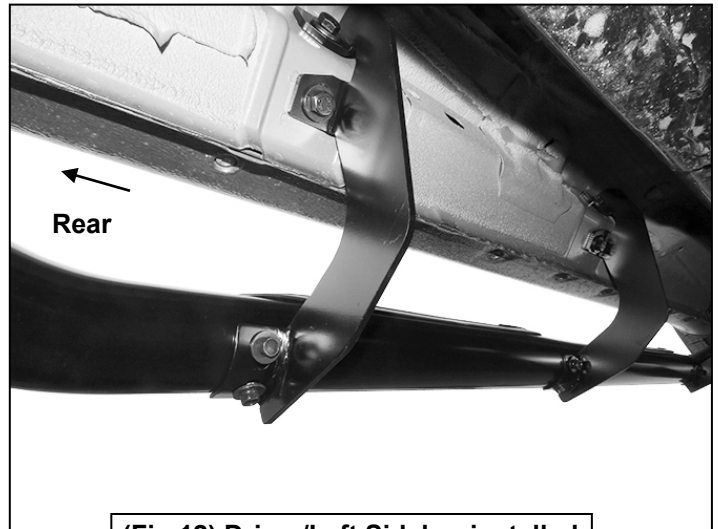

(Fig 12) Driver/Left Sidebar installed on Rear Mounting Bracket

No.	Parts Identification
1	Passenger / Right 'Rear' Bracket marked "PR"
2	Driver / Left 'Rear' Bracket marked "DR"
3	Passenger / Right 'Center' Bracket marked "PC"
4	Driver / Left 'Center' Bracket marked "DC"
5	Passenger / Right 'Front' Bracket marked "PF"
6	Driver / Left 'Front' Bracket marked "DF"

Note:

- This guide is to identify the parts and not a reference for part count.
- For part count, refer Parts List.
- Product / Bracket image is representative and actual design may vary.

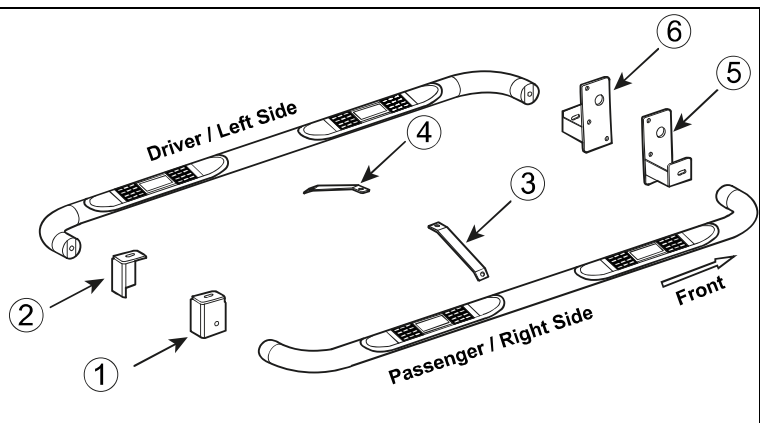

PRODUCT CARE

- Periodically check the product to ensure all fasteners are tight and components are intact.
- Regular waxing is recommended to protect the finish of the product.
- **Use ONLY Non-Abrasive automotive wax.** Use of any soap, polish or wax that contains an abrasive is detrimental and can scratch the finish leading to corrosion.
- Aluminum polish may be used to polish small scratches and scuffs for **Stainless Steel finish.**
- Mild soap may be used to clean the product for both **Stainless Steel and Black finish.**

FAQ's

- 1. Hardware's are not of correct size.**
In GMC / Chevrolet truck model 2006 & up, customer needs to reuse the factory body bolts to install the bracket. If your vehicle is not GMC / Chevrolet 2006 & up, ensure that holes are not partially covered with any plastic grommet or rust? If it is, remove the plastic grommet & rust from the thread holes & re-try the installation.
- 2. Mounting Bracket are not getting Installed properly.**
In some cases Illustration images shown in Installation manual may not be the exactly same as per actual vehicle images ,also if Driver / Passenger side mounting brackets are very identical in the design, suggest referring Parts Identification guide to avoid fitment issue.
- 3. Products are thumping / rattling after installation.**
Ensure that all required mounting brackets / hardware's are installed & tighten correctly. Suggest using white lithium / regular grease between the metal to metal contact surfaces.
- 4. Side Bar is not aligning with vehicle / Step Pads are not aligning with vehicle doors.**
Side bar may be interchanged or mounting brackets are not installed at the correct position in the vehicle. Refer Parts identification guide.
- 5. Missing / Excess Hardware.**
Recheck hardware count as per the part list.
- 6. Product not installing properly.**
Ensure make model year, cab length and bed size of your vehicle is listed in the application. All installation steps are followed correctly.

Check out these other TrailFX Products!!



Keystone Automotive Operations Inc. (KAO) warrants this product to be free of defects in material and workmanship at the time of purchase by the original retail consumer. KAO disclaims any other warranties, express or implied, including the warranty of fitness for a particular purpose or an intended use. If the product is found to be defective, KAO may replace or repair the product at our option, when the product is returned prepaid, with proof of purchase. Alteration to, improper installation, or misuse of this product voids the warranty. KAO's liability is limited to repair or replacement of products found to be defective, and specifically excludes liability for any incidental or consequential loss or damage.