



3" Side Bar

Part No. A0057S /B



Fits: 2019 Chevy Silverado/GMC Sierra 1500 Crew Cab
Excludes Body Lift Kit



60-180 min

Cutting Not Required

Drilling Not Required



REMOVE CONTENTS FROM BOX. VERIFY ALL PARTS ARE PRESENT.



READ INSTRUCTIONS CAREFULLY BEFORE STARTING INSTALLATION.

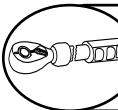

DO NOT OVER TORQUE. STANDARD OPERATING LOAD FOR TIGHTEN BODY MOUNT NUTS & BOLTS VARIES FROM 45 TO 65 FOOT POUND.

PARTS LIST:

Qty	Part Description	Qty	Part Description
1	Driver/left side 3" Oval Bent End Sidebar	1	Passenger/right Rear Mounting Bracket
1	Passenger/right side 3" Oval Bent End Sidebar	4	1/2" x 2" Hex Bolts
1	Driver/left Front Mounting Bracket	4	1/2" Lock Washers
1	Passenger/right Front Mounting Bracket	4	1/2" x 1-1/2" OD x 1/8" Large Flat Washers
2	Center Support Brackets	2	8-1.25mm x 25mm Combo Bolts
1	Driver/left Rear Mounting Bracket		

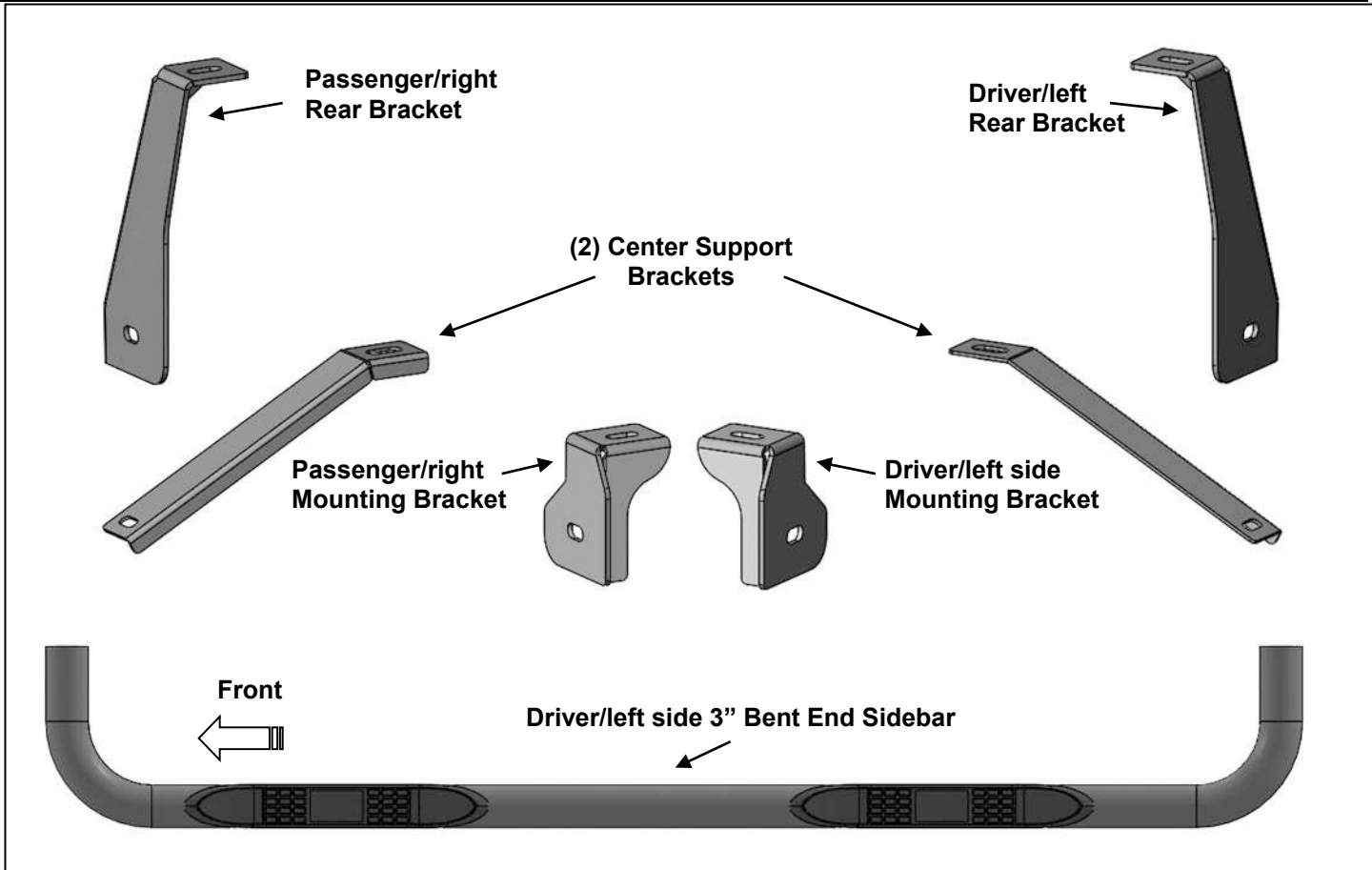

PROCEDURE:

REMOVE CONTENTS FROM BOX. VERIFY ALL PARTS ARE PRESENT. READ INSTRUCTIONS CAREFULLY BEFORE STARTING INSTALLATION. ASSISTANCE IS RECOMMENDED.

1. Start the installation under the driver/left side of the vehicle. Locate the front body mount, **(Figure 1)**. Remove the front body bolt.
2. Select the Driver/left side Front Bracket, **(Figure 2)**. Line up the upper slot on the Bracket with the body bolt hole. Reuse the factory body bolt to attach the Bracket to the top of the body mount, **(Figure 2)**.
3. Move to the center mounting location, **(Figure 3)**. Repeat **Steps 1 & 2** to install (1) Center Support Bracket to the center body mount, **(Figure 4)**.
4. Move to the rear mounting location, **(Figure 5)**. Repeat **Steps 1 & 2** to install the Rear Mounting Bracket to the rear body mount, **(Figure 6)**.
5. Carefully unwrap and select the Driver/left Sidebar. Use the illustration above to help identify the correct Sidebar. With assistance, line up the front end of the tube with the front Bracket slot, **(Figure 7)**. Use (1) 1/2" Hex Bolt, (1) 1/2" Lock Washer and (1) 1/2" Flat Washer to attach the front end of the Sidebar tube to the Front Bracket, **(Figure 8)**. Snug but do not tighten hardware at this time.
6. Attach the Sidebar to the Center Support Bracket using (1) 8mm Combo Bolt, **(Figures 9 & 10)**. Do not tighten hardware at this time.
7. Repeat **Step 5** to attach the rear end of the Sidebar to the Rear Bracket, **(Figures 11 & 12)**.
8. Level and adjust the Sidebar as necessary and fully tighten all hardware.
9. Repeat **Steps 1—8** for Passenger/right Sidebar installation.
10. Do periodic inspections to the installation to make sure that all hardware is secure and tight.

To protect your investment, wax this product after installing. Regular waxing is recommended to add a protective layer over the finish. Do not use any type of polish or wax that may contain abrasives that could damage the finish. Mild soap may be used also to clean the Sidebar.

Driver/left Side Installation Pictured

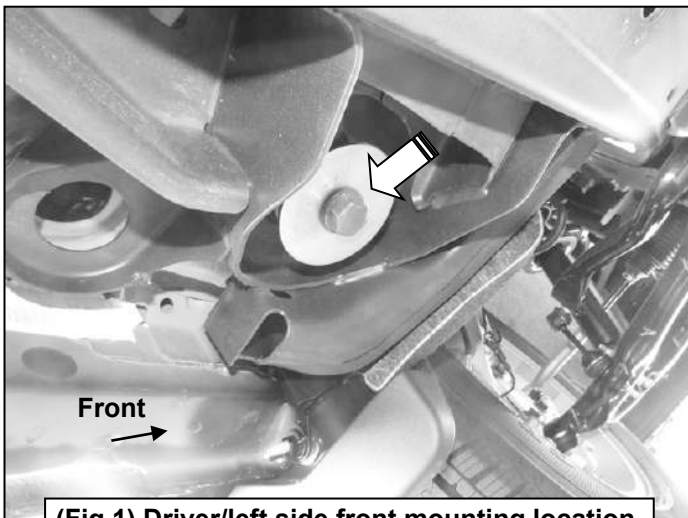

(Fig 1) Driver/left side front mounting location

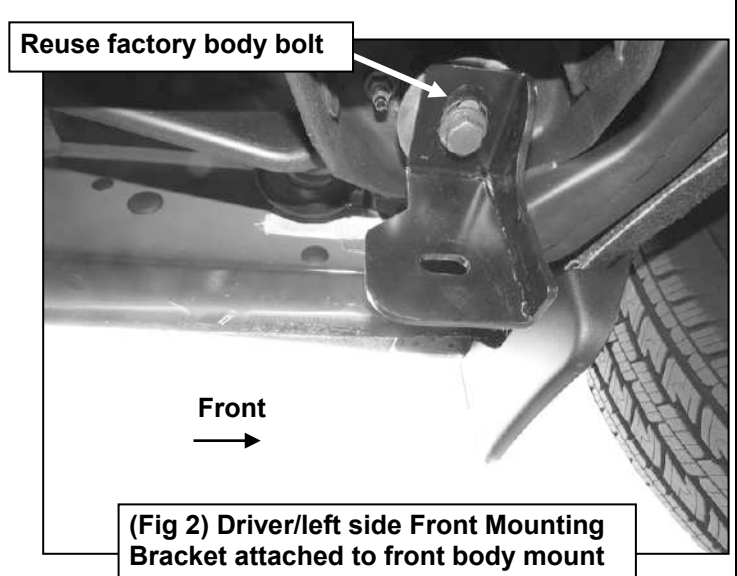

(Fig 2) Driver/left side Front Mounting Bracket attached to front body mount

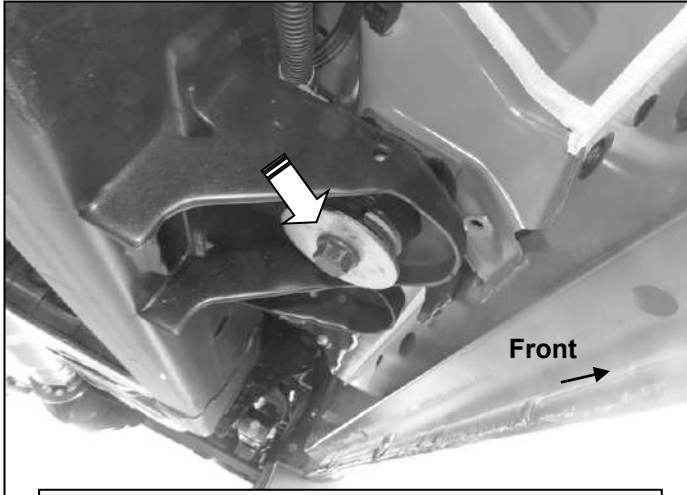

(Fig 3) Driver/left side center mounting location

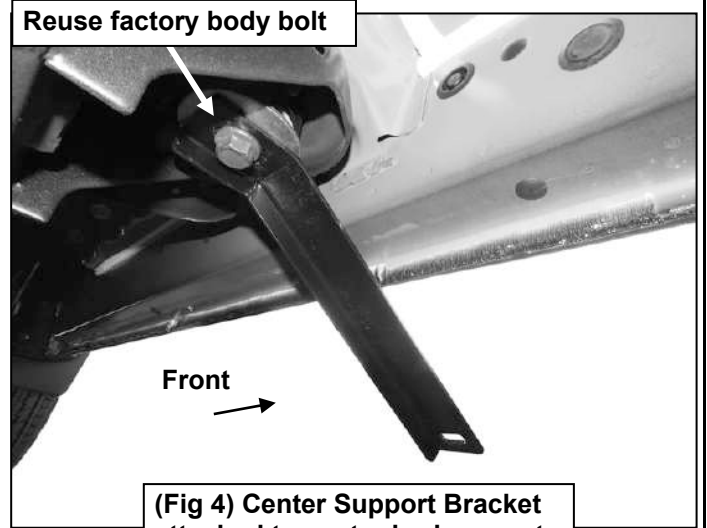

(Fig 4) Center Support Bracket attached to center body mount

Driver/left Side Installation Pictured

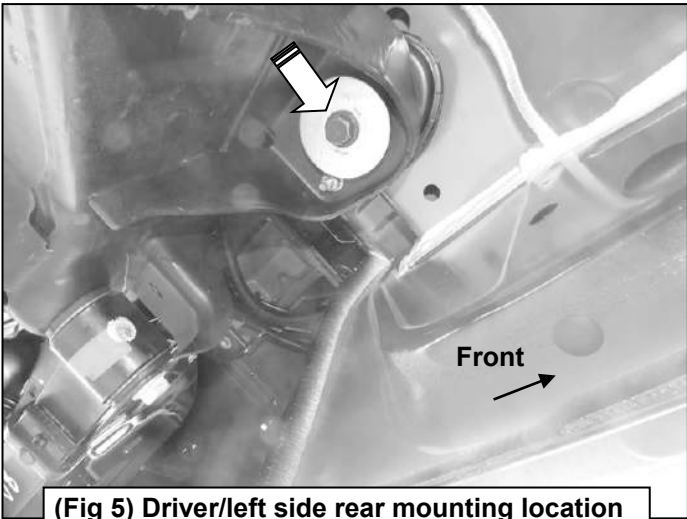

(Fig 5) Driver/left side rear mounting location

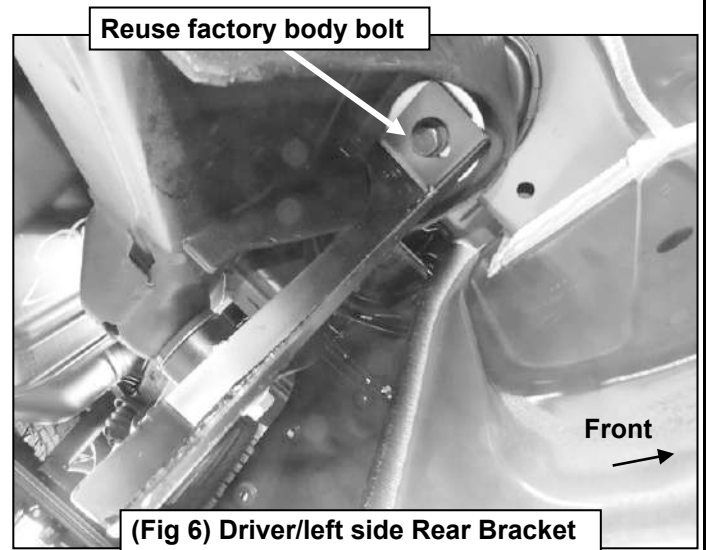

(Fig 6) Driver/left side Rear Bracket attached to the rear body mount

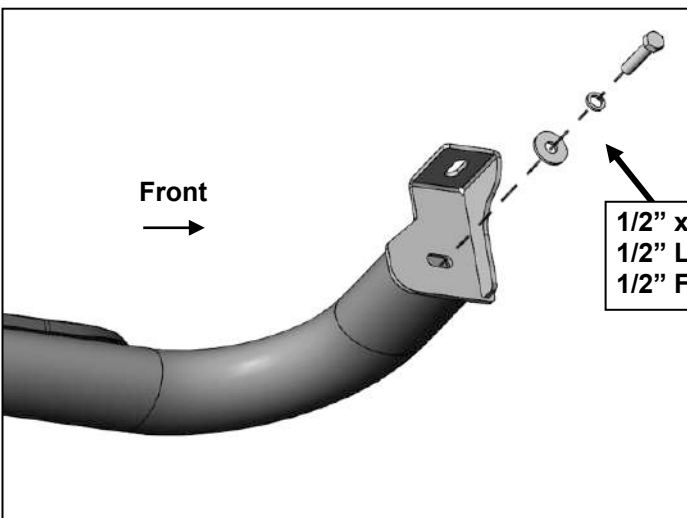

(Fig 7) Driver/left front of Sidebar attached to Front Mounting Bracket illustrated

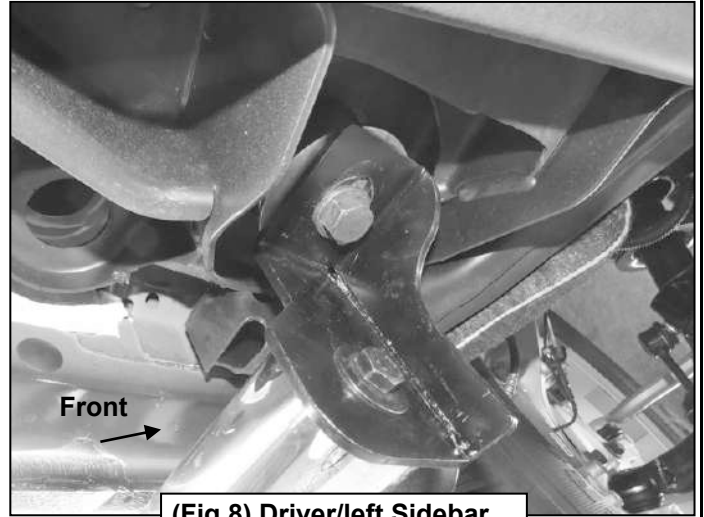

(Fig 8) Driver/left Sidebar attached to Front Bracket

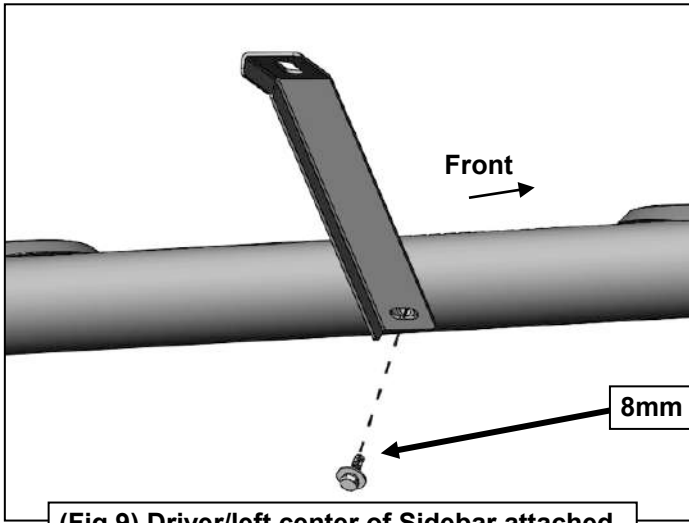

8mm Combo Bolt

(Fig 9) Driver/left center of Sidebar attached to Center Support Bracket illustrated

Driver/left Side Installation Pictured

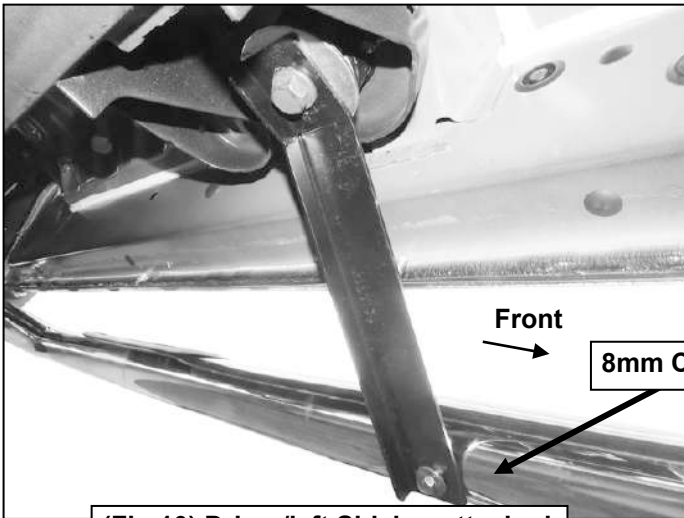

8mm Combo Bolt

(Fig 10) Driver/left Sidebar attached to Center Support Bracket

1/2" x 2" Hex Bolt
1/2" Lock Washer
1/2" Flat Washer

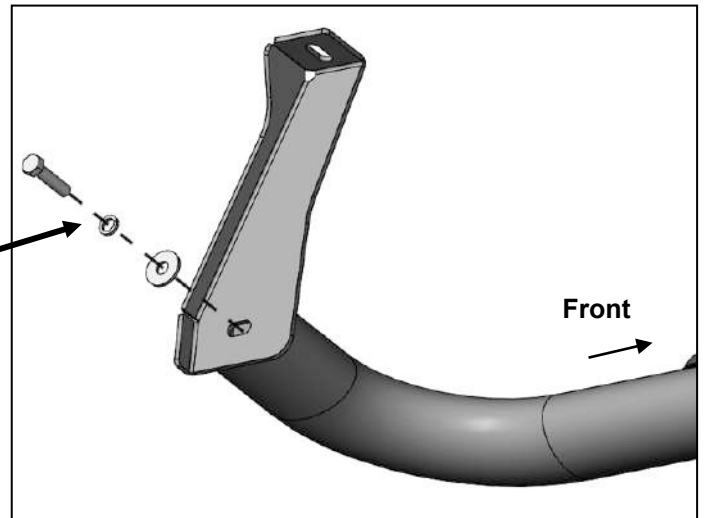

(Fig 11) Driver/left rear of Sidebar attached to the Rear Mounting Bracket illustrated

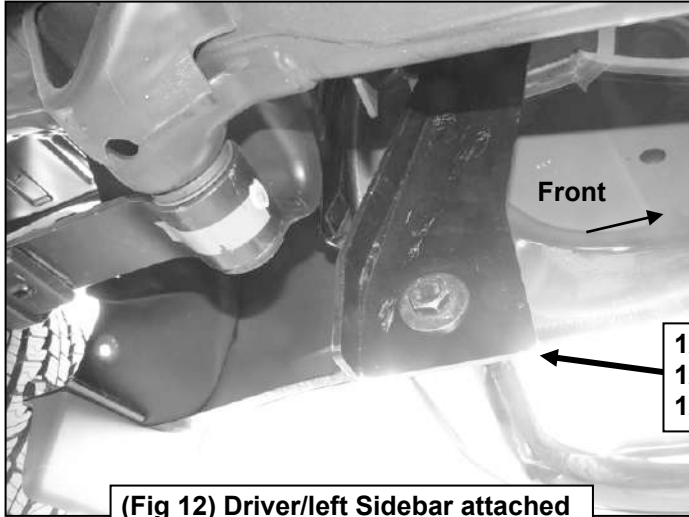

(Fig 12) Driver/left Sidebar attached to the Rear Mounting Bracket

No.	Parts Identification
1	Passenger / Right 'Rear' Bracket marked "PR"
2	Driver / Left 'Rear' Bracket marked "DR"
3	Passenger / Right 'Center' Bracket marked "PC"
4	Driver / Left 'Center' Bracket marked "DC"
5	Passenger / Right 'Front' Bracket marked "PF"
6	Driver / Left 'Front' Bracket marked "DF"

Note:

- This guide is to identify the parts and not a reference for part count.
- For part count, refer Parts List.
- Product / Bracket image is representative and actual design may vary.

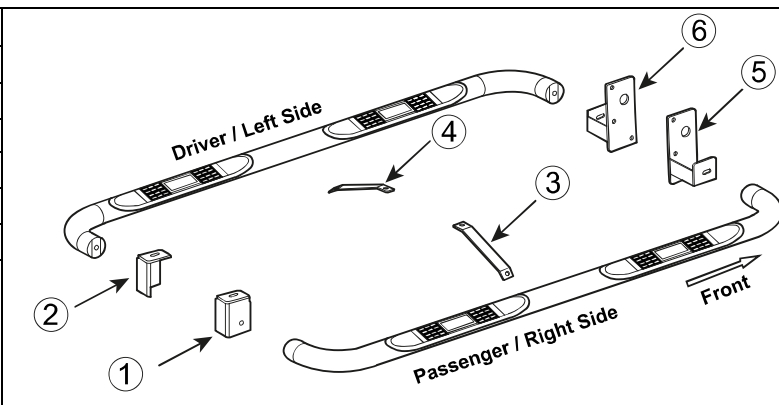

PRODUCT CARE

- Periodically check the product to ensure all fasteners are tight and components are intact.
- Regular waxing is recommended to protect the finish of the product.
- **Use ONLY Non-Abrasive automotive wax.** Use of any soap, polish or wax that contains an abrasive is detrimental and can scratch the finish leading to corrosion.
- Aluminum polish may be used to polish small scratches and scuffs for **Stainless Steel finish.**
- Mild soap may be used to clean the product for both **Stainless Steel and Black finish.**

FAQ's

- 1. Hardware's are not of correct size.**
In GMC / Chevrolet truck model 2006 & up, customer needs to reuse the factory body bolts to install the bracket. If your vehicle is not GMC / Chevrolet 2006 & up, ensure that holes are not partially covered with any plastic grommet or rust? If it is, remove the plastic grommet & rust from the thread holes & re-try the installation.
- 2. Mounting Bracket are not getting Installed properly.**
In some cases Illustration images shown in Installation manual may not be the exactly same as per actual vehicle images ,also if Driver / Passenger side mounting brackets are very identical in the design, suggest referring Parts Identification guide to avoid fitment issue.
- 3. Products are thumping / rattling after installation.**
Ensure that all required mounting brackets / hardware's are installed & tighten correctly. Suggest using white lithium / regular grease between the metal to metal contact surfaces.
- 4. Side Bar is not aligning with vehicle / Step Pads are not aligning with vehicle doors.**
Side bar may be interchanged or mounting brackets are not installed at the correct position in the vehicle. Refer Parts identification guide.
- 5. Missing / Excess Hardware.**
Recheck hardware count as per the part list.
- 6. Product not installing properly.**
Ensure make model year, cab length and bed size of your vehicle is listed in the application. All installation steps are followed correctly.

Check out these other TrailFX Products!!



Keystone Automotive Operations Inc. (KAO) warrants this product to be free of defects in material and workmanship at the time of purchase by the original retail consumer. KAO disclaims any other warranties, express or implied, including the warranty of fitness for a particular purpose or an intended use. If the product is found to be defective, KAO may replace or repair the product at our option, when the product is returned prepaid, with proof of purchase. Alteration to, improper installation, or misuse of this product voids the warranty. KAO's liability is limited to repair or replacement of products found to be defective, and specifically excludes liability for any incidental or consequential loss or damage.