



3" Nerf Bar

Part No. A0037S/B



Fits: **2015 Chevrolet Colorado Extended Cab**
2015 GMC Canyon Extended Cab

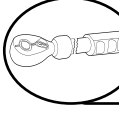

REMOVE CONTENTS FROM BOX. VERIFY ALL PARTS ARE PRESENT.

READ INSTRUCTIONS CAREFULLY BEFORE STARTING INSTALLATION.

DO NOT OVER TORQUE. STANDARD OPERATING LOAD FOR TIGHTEN BODY MOUNT NUTS & BOLTS VARIES FROM **45** TO **65** FOOT POUND.



60-180 min

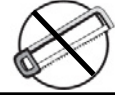

Cutting Not Required



Drilling Not Required

PARTS LIST:

Qty	Part Description	Qty	Part Description
1	Driver/left Sidebar	4	1/2" x 2" Hex Bolts
1	Passenger/right Sidebar	4	1/2" x 1-1/4" OD x 3/32" Flat Washers
1	Driver/left Front Mounting Bracket	4	1/2" Lock Washers
1	Passenger/right Front Mounting Bracket	12	8mm Clip Nuts
1	Driver/left Front Support Bracket	16	8-1.25mm x 25mm Hex Bolts
1	Passenger/right Front Support Bracket	16	8mm x 24mm OD x 2mm Washer
2	Center Brackets (use left or right)	16	8mm Lock Washers
1	Driver/left Rear Mounting Bracket	4	6-1.0mm x 20mm Hex Bolts
1	Passenger/right Rear Mounting Bracket	4	6mm x 18mm OD x 1.6mm Flat Washers

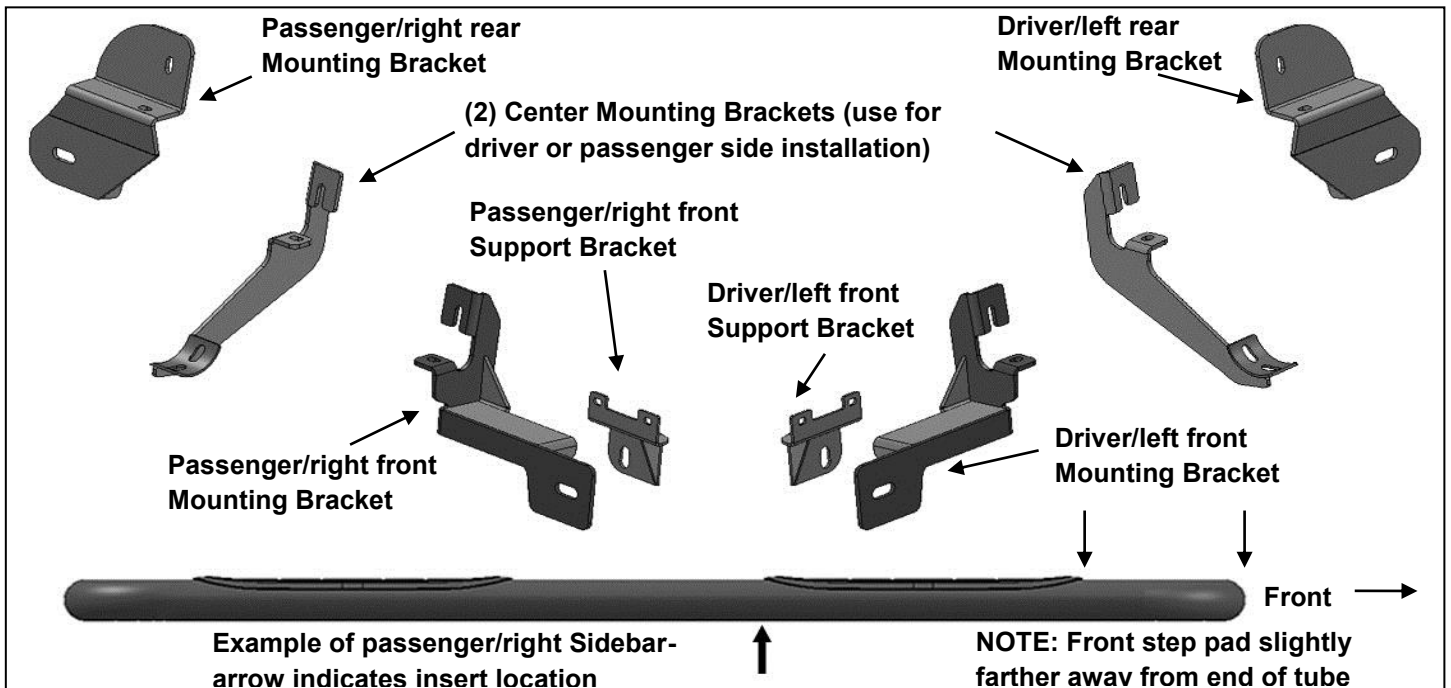

INSTALLATION PROCEDURE:

1. Start the installation under the passenger side of the vehicle. Locate the 4 factory running board mounting locations along the bottom and inner side of the body, **(Figure 1)**. Mounting Brackets will bolt to the 1st, 2nd and 4th mounting locations. **NOTE:** It may help to hold a Bracket up in place to help determine the mounting holes to use along the bottom and inner side of the body.
2. Move to the front mounting location at the bottom corner of the body. Remove the rubber plugs from the bottom and side of the body panel as necessary, **(Figure 2)**. Select (2) 8mm Clip Nuts. Slide the Clip Nuts into the large holes and over the smaller holes. Line up the threaded nut on the Clip Nut with smaller hole in body panel, **(Figure 3)**.

Passenger/right Side Installation Pictured

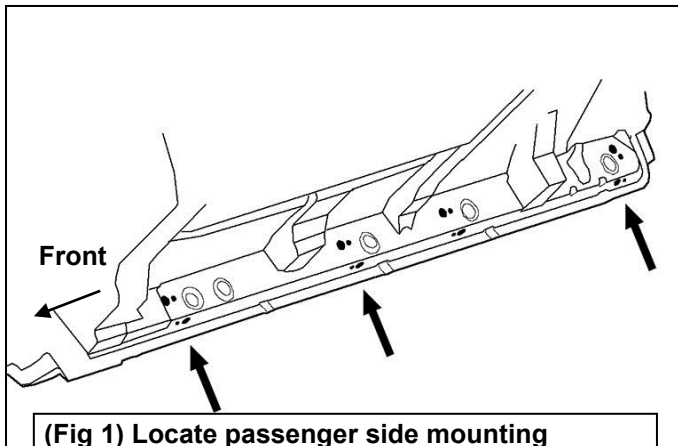

(Fig 1) Locate passenger side mounting locations along bottom and back of body panel

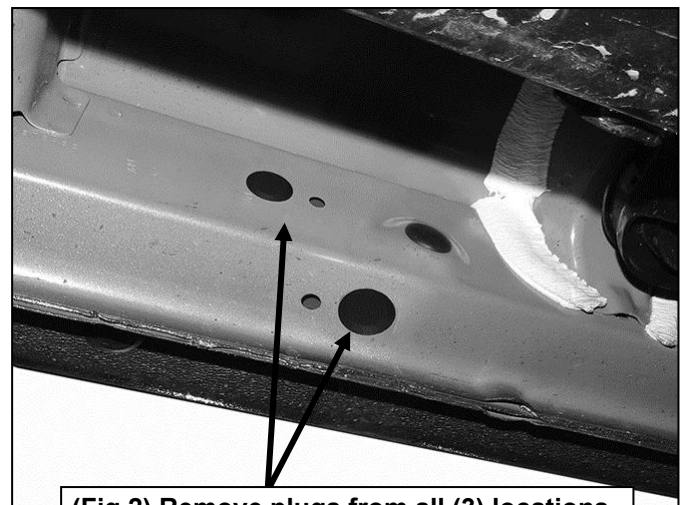

(Fig 2) Remove plugs from all (3) locations

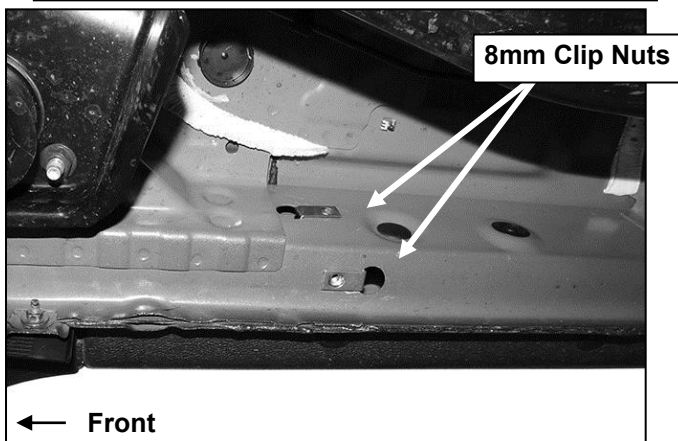

(Fig 3) Slide 8mm Clip Nut into large hole and over small hole. Passenger front location pictured

3. Select the passenger side front Mounting Bracket. Line up the holes in the Bracket with the (2) Clip Nuts. Attach the Bracket to the Clip Nuts with (2) 8mm Hex Bolts, (2) 8mm Lock Washers and (2) 8mm Flat Washers, **(Figure 4)**. Leave hardware loose at this time
4. Next, carefully pull back the plastic lower fender cover and remove the (2) factory bolts in the bottom of the fender, **(Figure 5)**. Select the passenger front Support Bracket, **(Figure 6)**. Attach the Bracket to the (2) threaded holes with (2) 6mm x 20mm Hex Bolts and (2) 6mm Flat Washers, **(Figure 7)**. **IMPORTANT:** Make sure the Support Bracket is behind the front Bracket. Snug but do not fully tighten hardware at this time.

Passenger/right Side Installation Pictured

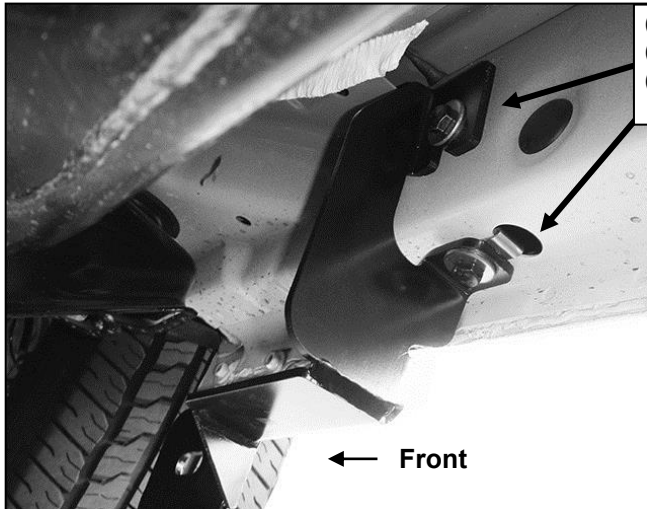

(2) 8mm x 25mm Hex Bolts
(2) 8mm Lock Washers
(2) 8mm Flat Washers

Remove (2) factory bolts
attaching bottom of front
fender

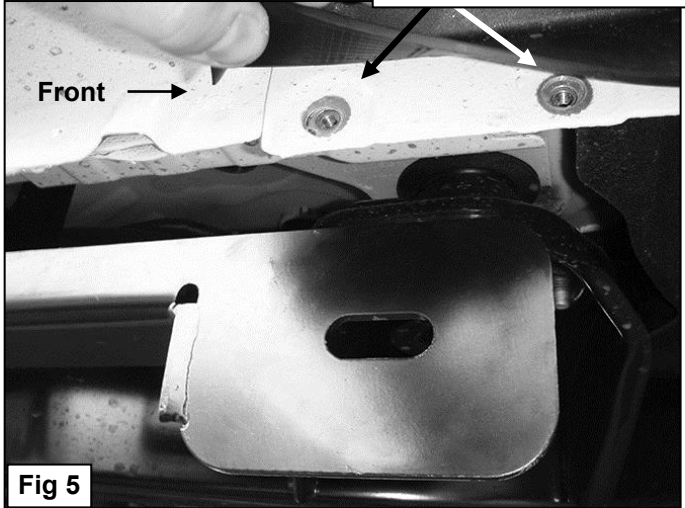
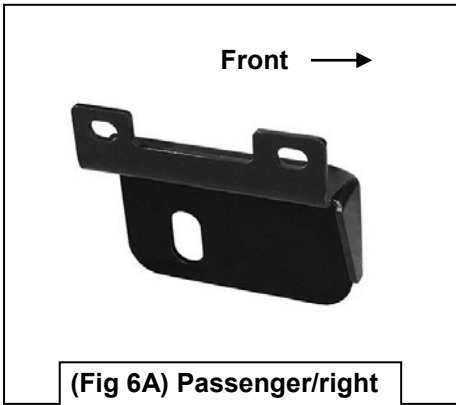

Fig 5

(Fig 4) Attach passenger front Bracket to Clip Nuts



**(Fig 6A) Passenger/right
front Support Bracket**

(2) 6mm x 20mm Hex Bolts
(2) 6mm Flat Washers

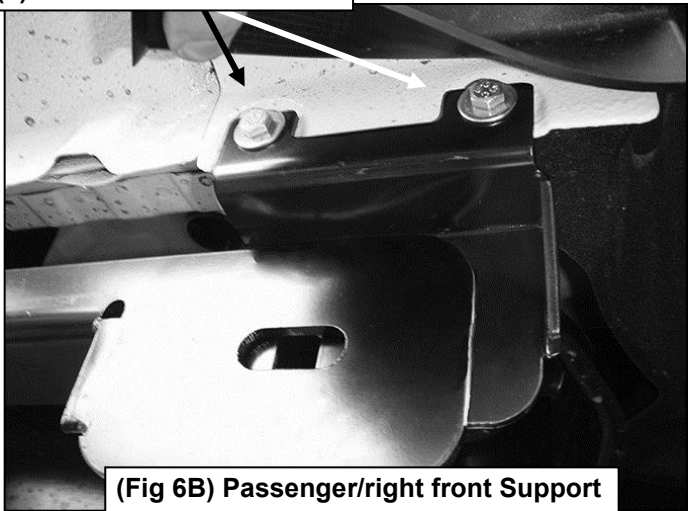

**(Fig 6B) Passenger/right front Support
Bracket behind Mounting Bracket**

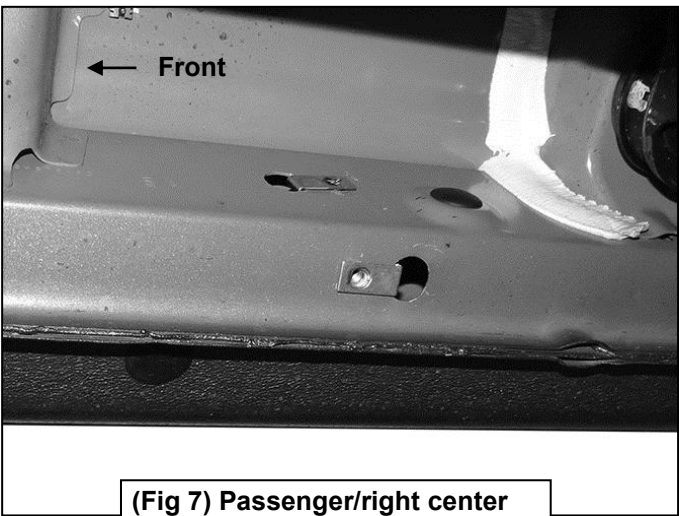

**(Fig 7) Passenger/right center
location pictured with Clip Nuts**

- Move along the side of the vehicle to the second mounting location, **(Figure 1)**. Repeat **Step 2** to install (2) 8mm Clip Nuts in the (2) factory holes in the body panel, **(Figure 7)**. Select (1) Center Bracket. **NOTE:** Center Bracket can be installed on either the driver or passenger side. Bolt the Mounting Bracket to the (2) Clip Nuts with (2) 8mm Hex Bolts, (2) 8mm Lock Washers and (2) 8mm Flat Washers, **(Figure 8)**. Snug but do not fully tighten the hardware.

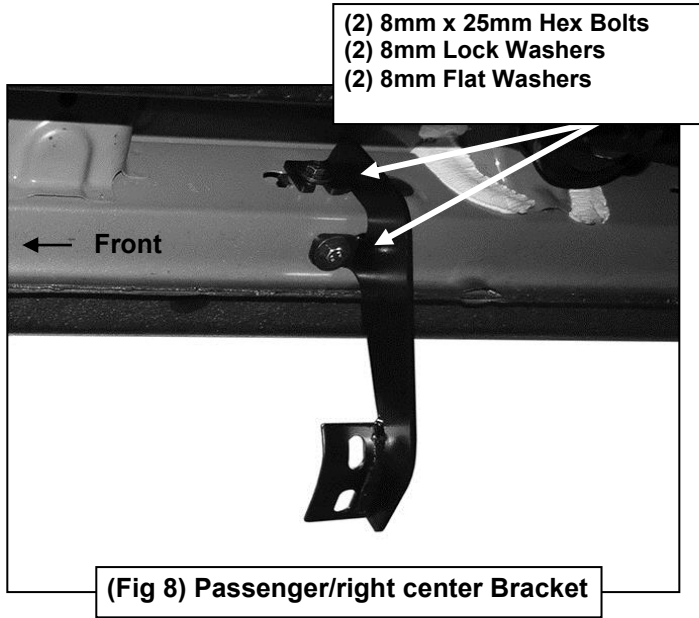

- Skip the third mounting location and move to the last location at the back of the cab, **(Figure 9)**. Repeat **Step 4** to install the passenger side rear Mounting Bracket, **(Figure 10)**.

Passenger/right Side Installation Pictured

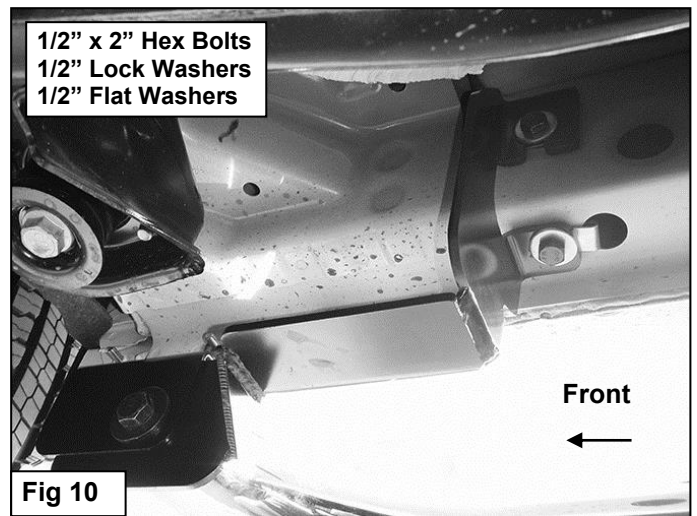
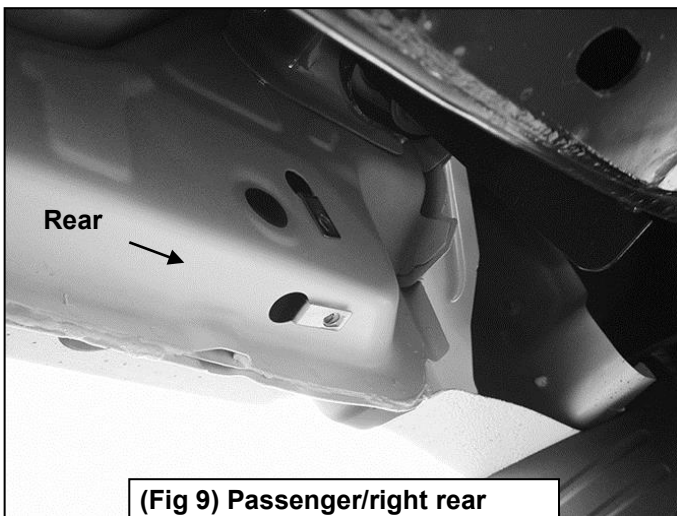

7. Select the passenger/right Sidebar. Carefully position the Sidebar up to the front and rear Mounting Brackets. Attach the Sidebar to the Mounting Brackets with (2) 1/2" x 2" Hex Bolts, (2) 1/2" Lock Washers, and (2) 1/2" Flat Washers, (**Figures 10 & 12**). Snug but do not tighten at this time.
8. Move to the Center Bracket. Line up the Bracket with the threaded inserts in the bottom of the Sidebar. Attach the Sidebar to the Bracket with (2) 8mm x 25mm Hex Bolts, (2) 8mm Lock Washers and (2) 8mm Flat Washers, (**Figure 11**). Do not tighten hardware.
9. Level and adjust the Sidebar and tighten all hardware.
10. Repeat **Steps 1—9** to install the driver/left Sidebar.
11. Do periodic inspections to the installation to make sure that all hardware is secure and tight.

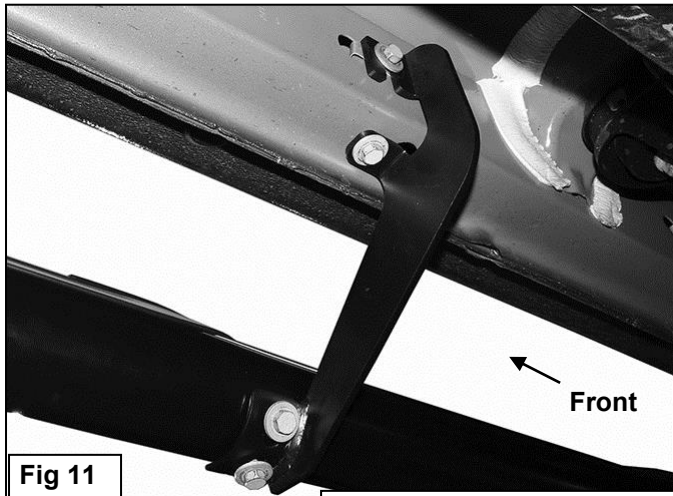
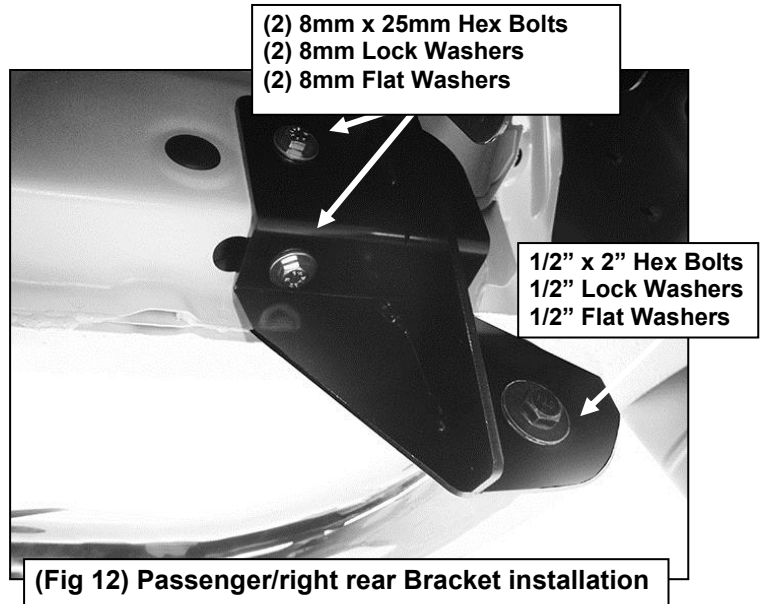

Fig 11

(2) 8mm x 25mm Hex Bolts
 (2) 8mm Lock Washers
 (2) 8mm Flat Washers



(Fig 12) Passenger/right rear Bracket installation

PARTS IDENTIFICATION GUIDE

Driver Side tube packed using "Green" color foam sheet. Passenger Side tube packed using "White" color foam sheet

No.	Parts Identification
1	Passenger / Right 'Rear' Bracket marked "PR"
2	Driver / Left 'Rear' Bracket marked "DR"
3	Passenger / Right 'Center' Bracket marked "PC"
4	Driver / Left 'Center' Bracket marked "DC"
5	Passenger / Right 'Front' Bracket marked "PF"
6	Driver / Left 'Front' Bracket marked "DF"

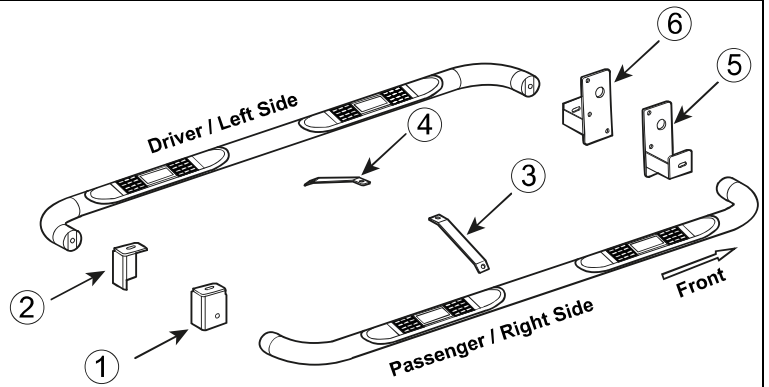

Note:

- This guide is to identify the parts and not a reference for part count.
- For part count, refer Parts List.
- Product / Bracket image is representative and actual design may vary.

PRODUCT CARE

- Periodically check the product to ensure all fasteners are tight and components are intact.
- Regular waxing is recommended to protect the finish of the product.
- **Use ONLY Non-Abrasive automotive wax.** Use of any soap, polish or wax that contains an abrasive is detrimental and can scratch the finish leading to corrosion.
- Aluminum polish may be used to polish small scratches and scuffs for **Stainless Steel finish.**
- Mild soap may be used to clean the product for both **Stainless Steel and Black finish.**

FAQ's

1. Hardware's are not of correct size.

In GMC / Chevrolet truck model 2006 & up, customer needs to reuse the factory body bolts to install the bracket. If your vehicle is not GMC / Chevrolet 2006 & up, ensure that holes are not partially covered with any plastic grommet or rust? If it is, remove the plastic grommet & rust from the thread holes & re-try the installation.

2. Mounting Bracket are not getting Installed properly.

In some cases Illustration images shown in Installation manual may not be the exactly same as per actual vehicle images ,also if Driver / Passenger side mounting brackets are very identical in the design, suggest referring Parts Identification guide to avoid fitment issue.

3. Products are thumping / rattling after installation.

Ensure that all required mounting brackets / hardware's are installed & tighten correctly. Suggest using white lithium / regular grease between the metal to metal contact surfaces.

4. Side Bar is not aligning with vehicle / Step Pads are not aligning with vehicle doors.

Side bar may be interchanged or mounting brackets are not installed at the correct position in the vehicle. Refer Parts identification guide.

5. Missing / Excess Hardware.

Recheck hardware count as per the part list.

6. Product not installing properly.

Ensure make model year, cab length and bed size of your vehicle is listed in the application. All installation steps are followed correctly.