



3" Side Bar

Part No. A0032S/B



Fits: 2007 – Current
2007 – Current

Chevrolet Silverado/Sierra 1500 Regular Cab
Chevrolet Silverado/Sierra 2500/3500 Regular Cab

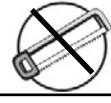

60-180 min

Cutting Not Required

Drilling Not Required



REMOVE CONTENTS FROM BOX. VERIFY ALL PARTS ARE PRESENT.



READ INSTRUCTIONS CAREFULLY BEFORE STARTING INSTALLATION.

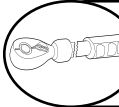

DO NOT OVER TORQUE. STANDARD OPERATING LOAD FOR TIGHTEN BODY MOUNT NUTS & BOLTS VARIES FROM 45 TO 65 FOOT POUND.

PARTS LIST:

Qty	Part Description	Qty	Part Description
1	Driver/left Sidebar	17	8-1.25mm x 25mm Hex Bolt
1	Passenger/right Sidebar	17	8mm x 24mm x 2mm Flat Washer
1	Passenger/right Front Upper Bracket (all incl. DEF)	17	8mm Lock Washer
1	Passenger/right Front Lower Bracket (all incl. DEF)	1	8mm Bolt Plate
3	3" Sidebar Brackets (use for left or right)	1	8mm Nylon Lock Nut (use w-bolt plate)
7	8-1.25mm Clip-On Nuts		

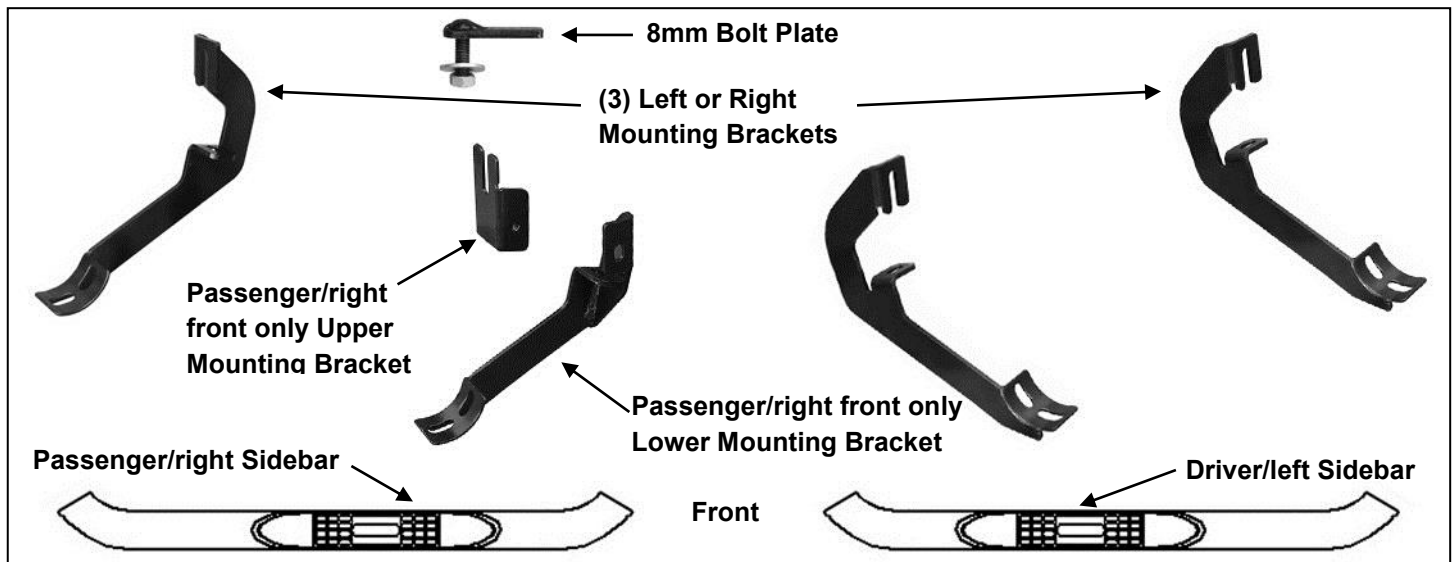

INSTALLATION PROCEDURE

- Start the installation under the driver side of the vehicle. Locate the tabs along the bottom edge of the body, (pinch weld). Mounting Brackets will bolt to the front and rear mounting tabs approximately 23-3/4" apart, (Figure 1). Directly above each tab is a top mounting location on the side of the body panel. Hold a Bracket and/or Sidebar up in place to help determine the mounting holes to use along the body.
- Determine the correct procedure for your model year and each Bracket location.
 - Bottom mounting location on the edge of the pinch weld.

Flat tab on pinch weld with factory installed weld nut:

Thread hex bolt into weld nut from the backside-down to clear paint from threads, (Figure 2).

Flat tab on pinch weld with hole:

Select (1) 8mm Clip Nut. Slide the Clip Nut over the tab with the nut facing up behind the tab, (Figures 3—5). Line up threaded nut with hole in tab. Repeat for each mounting location.

Top mounting location on the side of the body panel.

Models with factory installed threaded insert in body panel:

Thread 8mm Hex Bolt into threaded insert to clear paint as required, (Figures 2 & 3).

Large and small hole in side of body panel:

Remove the rubber plug from the larger hole, (Figure 4). Select (1) 8mm Clip Nut. Slide the Clip Nut into the larger hole. Line up the threaded nut with the smaller hole, (Figure 5).

Driver/Left Side Installation Pictured

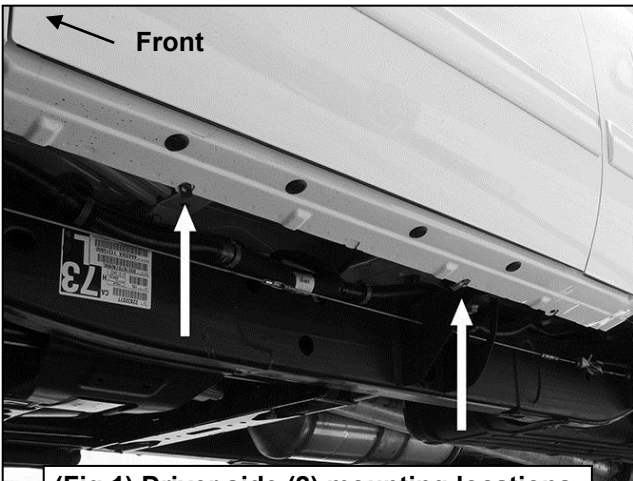

(Fig 1) Driver side (2) mounting locations

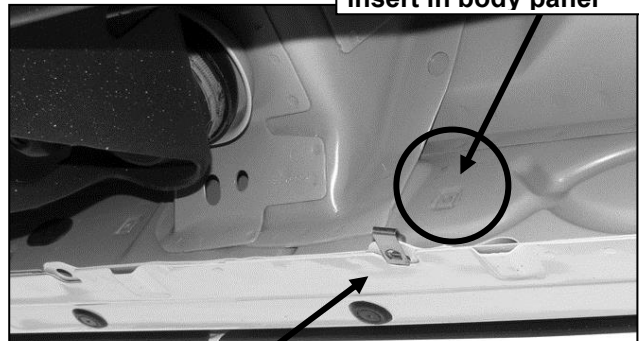

Use 8mm Clip Nut

(Fig 3) Example of factory hole in flat mounting tab and threaded hole in body panel

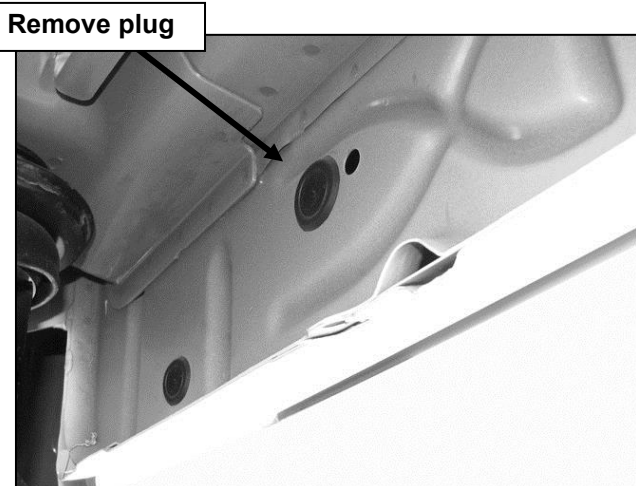

(Fig 4) Example of large hole in inner body panel

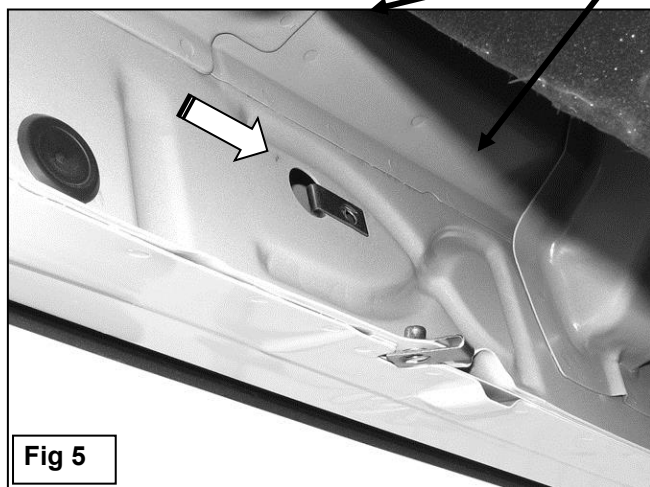
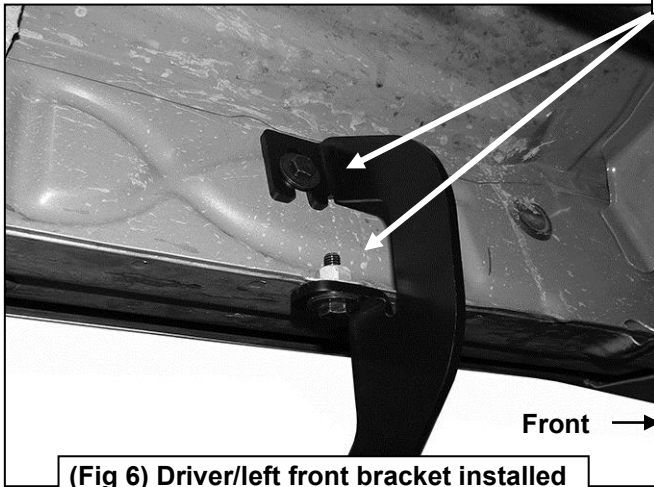

Fig 5

3. Select (1) Mounting Bracket. **NOTE:** (3) Brackets are universal, (2) will be used on the driver side and (1) will install in the passenger rear location. Bolt the Mounting Bracket to the Clip Nuts and/or the factory threaded holes with (2) 8mm Hex Bolts, (2) 8mm Lock Washers and (2) 8mm Flat Washers, (Figures 6 & 7). Snug but do not fully tighten the hardware.

(2) 8mm x 25mm Hex Bolts
(2) 8mm Lock Washers
(2) 8mm Flat Washers



(Fig 6) Driver/left front bracket installed



(Fig 7) Example of Bracket bolted to 8mm Clip Nuts on mounting tab and inner body panel

4. Repeat **Steps 1—3** to install the driver side rear Bracket.
5. Select the driver/left sidebar. Carefully position the Driver Sidebar onto the (2) Mounting Brackets. **IMPORTANT:** Do not slide, (front to back or rotate), the Sidebar on the Brackets or damage to the finish on the Sidebar may result. Attach the Sidebar to the Mounting Brackets with (4) 8mm x 25mm Hex Bolts, (4) 8mm Lock Washers and (4) 8mm Flat Washers, (Figure 8). Do not tighten hardware.
6. Level and adjust the Sidebar and tighten all hardware.

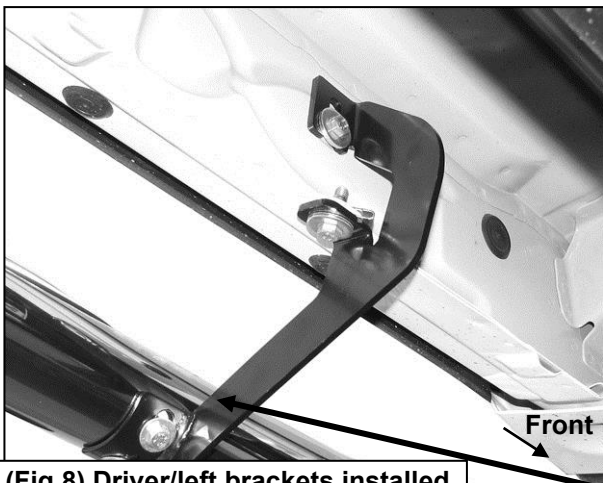

(Fig 8) Driver/left brackets installed

(2) 8mm x 25mm Hex Bolts
(2) 8mm Lock Washers
(2) 8mm Flat Washers

7. Move to the passenger side of the vehicle. On the passenger side, determine if the vehicle is equipped with a plastic diesel exhaust fluid (DEF) tank, (Figures 9 & 10).
- a. **Models without DEF tank, skip to Step 8.**

Models with DEF tank: The tank sits close to the side of the body. With specialized tools, the passenger front upper and lower Bracket can be installed but room is limited. It may be easier to drop the tank down to access the inner side of the body panel for upper bracket installation. Tank will not need to be removed, only dropped down for access to mounting location. **IMPORTANT:** If tank is full, it will be very heavy and assistance is highly recommended to avoid injury or damage to the vehicle or the tank. It is recommended that installation is performed when the DEF tank is low on fluid before dropping the tank.

- a. On models with plastic lower tray under the tank, remove the (3) hex bolts attaching the tray to the frame, (Figure 9), and remove the tray.
- b. Release the tank filler hose. Release the plug for the sending unit on the top of the tank.

- c. Support the tank with a floor jack. Place a smooth flat surface, (wooden block for example), between the floor jack and the tank to avoid damaging the plastic tank. Do not push up on the tank; only support the weight of the tank with the jack.
- d. Remove the (2) bolts securing the tank straps to the vehicle, **(Figure 10)**. Tilt the straps to release from the brackets. Slowly lower the tank until the top of the tank is almost visible. Use blocks or stands to support the tank while installing the front Upper and Lower Brackets.
- e. Proceed to **Step 8**.

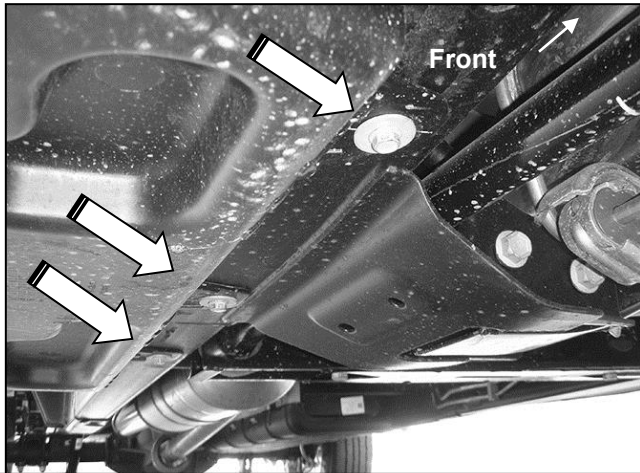

(Fig 9) Passenger side front pictured with DEF tank cover. Remove (3) hex bolts to remove cover

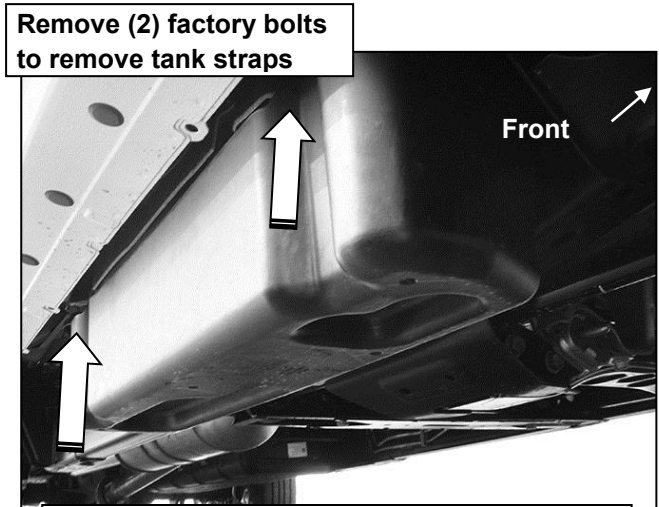

Remove (2) factory bolts to remove tank straps

(Fig 10) Passenger side DEF tank and cover

8. Locate the first tab on the edge of the pinch weld, **(Figures 2—4, 12 & 14)**. Select the Upper Bracket, **(Figure 11)**. Repeat **Steps 2 & 3** to attach the passenger front Upper Bracket to the side of the body panel, **(Figure 12)**. Do not tighten hardware at this time.
9. Line up the hole in the bottom of the Upper Bracket with the hole in the tab on the pinch weld.
 - a. **Models with a weld-nut:** Slide the Bracket over the weld-nut, **(Figure 12)**. Attach the Lower Bracket to the bottom of the body and weld-nut with (1) 8mm x 25mm Hex Bolt, (1) 8mm Lock Washer and (1) 8mm Flat Washer, **(Figures 15 & 16)**. Leave loose at this time.
 - b. **Models with flat tab and hole:** Insert the 8mm Bolt Plate down through the hole in the Upper Bracket and mounting tab, **(Figures 13 & 14)**. Attach the Lower Bracket to the bottom of the body and Bolt Plate with (1) 8mm Flat Washer and (1) 8mm Nylon Lock Nut, **(Figures 15 & 16)**. Leave loose at this time.

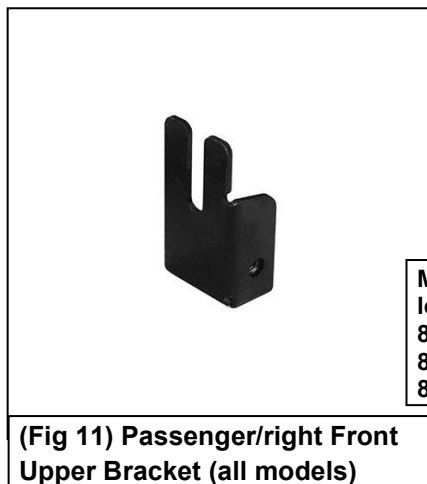

(Fig 11) Passenger/right Front Upper Bracket (all models)

**8mm x 25mm Hex Bolt
8mm Lock Washer
8mm Flat Washer**

**Models with weld nut on tab, attach lower Bracket to weld nut with:
8mm x 25mm Hex Bolt
8mm Lock Washer
8mm Flat Washer**

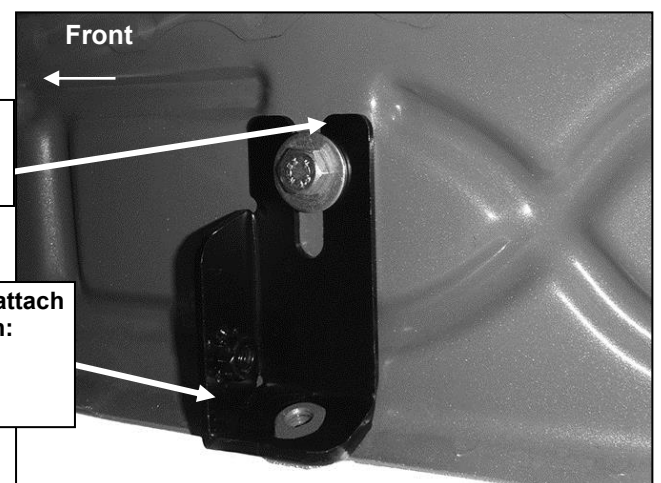

(Fig 12) Slide Upper Bracket over weld nut (if equipped-see Figure 2)

10. Line up the side tab on the Lower Bracket with the threaded hole in the side of the Upper Bracket. Attach the Lower Bracket to the Upper Bracket with (1) 8mm x 25mm Hex Bolt, (1) 8mm Lock Washer and (1) 8mm Flat Washer, **(Figure 16)**. Leave loose at this time.
11. Repeat **Steps 1—3** to install the passenger side rear Bracket. **NOTE:** Cradles on Brackets installed on passenger side will face forward.
12. Repeat **Steps 5 & 6** to install the passenger Sidebar. **(Figure 17)**.
13. Once the Sidebars are fully installed and all hardware fully tightened, reinstall the DEF tank and cover, if equipped, as described in **Step 7**.
14. Do periodic inspections to the installation to make sure that all hardware is secure and tight.



(Fig 13) 8mm x 35mm Bolt Plate

On models with flat tab (see Fig. 3, 4 and 16), insert 8mm Bolt Plate (Fig 13) down through Upper Bracket and mounting tab

8mm x 25mm Hex Bolt
8mm Lock Washer
8mm Flat Washer

8mm Bolt Plate

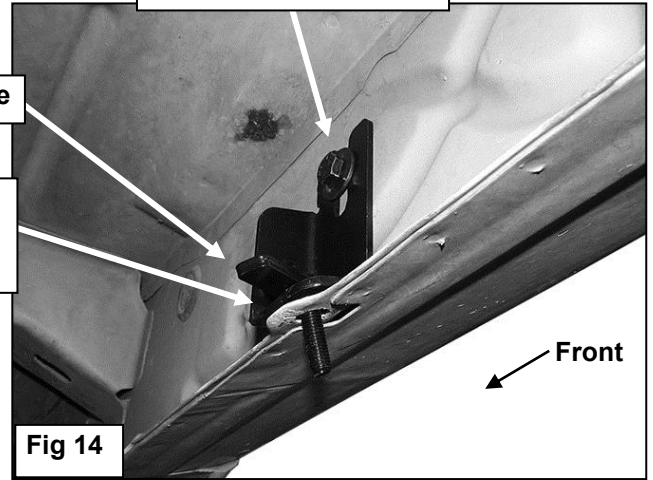

Fig 14

On models with flat tab and 8mm Bolt Plate (see Fig. 14) use:
8mm Flat Washer
8mm Nylon Lock Nut
to attach Lower Bracket to Bolt Plate

All models use:
8mm x 25mm Hex Bolt
8mm Lock Washer
8mm Flat Washer



(Fig 15) Passenger/right Front Lower Bracket (all models)



Fig 16

Models with weld nut on tab use:
8mm x 25mm Hex Bolt
8mm Lock Washer
8mm Flat Washer
to bolt Lower Bracket to weld nut

(2) 8mm x 25mm Hex Bolts
(2) 8mm Lock Washers
(2) 8mm Flat Washers

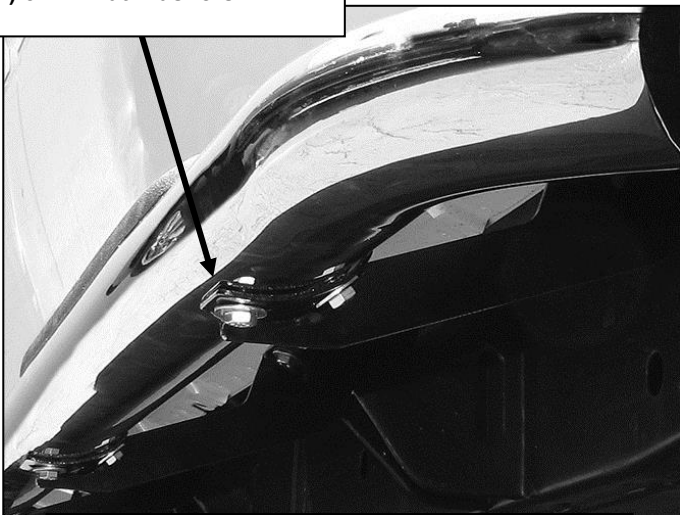

(Fig 17) Passenger side installation pictured



Complete Installation

PARTS IDENTIFICATION GUIDE

Driver Side tube packed using "Green" color foam sheet. Passenger Side tube packed using "White" color foam sheet

No.	Parts Identification
1	Passenger / Right 'Rear' Bracket marked "PR"
2	Driver / Left 'Rear' Bracket marked "DR"
3	Passenger / Right 'Center' Bracket marked "PC"
4	Driver / Left 'Center' Bracket marked "DC"
5	Passenger / Right 'Front' Bracket marked "PF"
6	Driver / Left 'Front' Bracket marked "DF"

Note:

- This guide is to identify the parts and not a reference for part count.
- For part count, refer Parts List.
- Product / Bracket image is representative and actual design may vary.

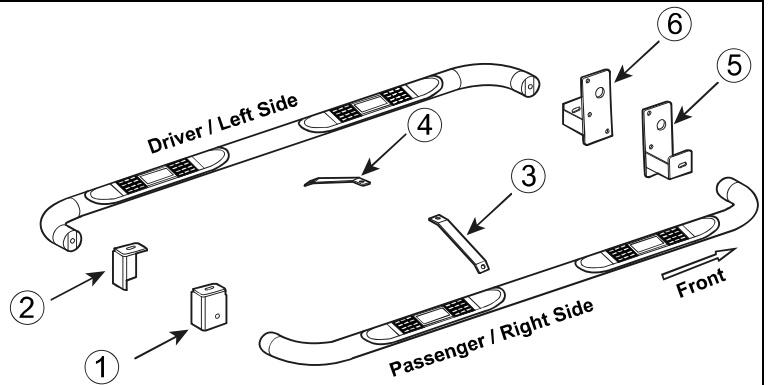

PRODUCT CARE

- Periodically check the product to ensure all fasteners are tight and components are intact.
- Regular waxing is recommended to protect the finish of the product.
- **Use ONLY Non-Abrasive automotive wax.** Use of any soap, polish or wax that contains an abrasive is detrimental and can scratch the finish leading to corrosion.
- Aluminum polish may be used to polish small scratches and scuffs for **Stainless Steel finish.**
- Mild soap may be used to clean the product for both **Stainless Steel and Black finish.**

FAQ's

1. Hardware's are not of correct size.

In GMC / Chevrolet truck model 2006 & up, customer needs to reuse the factory body bolts to install the bracket. If your vehicle is not GMC / Chevrolet 2006 & up, ensure that holes are not partially covered with any plastic grommet or rust? If it is, remove the plastic grommet & rust from the thread holes & re-try the installation.

2. Mounting Bracket are not getting Installed properly.

In some cases Illustration images shown in Installation manual may not be the exactly same as per actual vehicle images ,also if Driver / Passenger side mounting brackets are very identical in the design, suggest referring Parts Identification guide to avoid fitment issue.

3. Products are thumping / rattling after installation.

Ensure that all required mounting brackets / hardware's are installed & tighten correctly. Suggest using white lithium / regular grease between the metal to metal contact surfaces.

4. Side Bar is not aligning with vehicle / Step Pads are not aligning with vehicle doors.

Side bar may be interchanged or mounting brackets are not installed at the correct position in the vehicle. Refer Parts identification guide.

5. Missing / Excess Hardware.

Recheck hardware count as per the part list.

6. Product not installing properly.

Ensure make model year, cab length and bed size of your vehicle is listed in the application. All installation steps are followed correctly.