

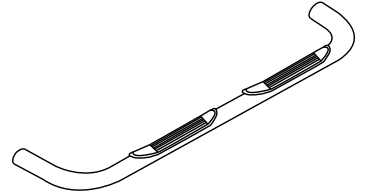

3" Side Bar

Part No. 1160632071/1160632073/A0027T



Fits: 2007 – Current

Jeep Wrangler JK 2 Door



30-60 min



Cutting Not Required



Drilling Not Required



REMOVE CONTENTS FROM BOX. VERIFY ALL PARTS ARE PRESENT.



READ INSTRUCTIONS CAREFULLY BEFORE STARTING INSTALLATION.

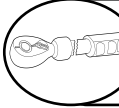

DO NOT OVER TORQUE. STANDARD OPERATING LOAD FOR TIGHTEN BODY MOUNT NUTS & BOLTS VARIES FROM 45 TO 65 FOOT POUND.

PARTS LIST:

Qty	Part Description	Qty	Part Description
1	Driver/Left Sidebar	4	10mm x 30mm OD x 2.5mm Flat Washers
1	Passenger/Right Sidebar	4	8-1.25mm x 35mm Hex Bolts
1	Driver/Left Front Mounting Bracket	8	8-1.25mm x 25mm Hex Bolts
1	Passenger/Right Front Mounting Bracket	12	8mm Lock Washers
1	Driver/Left Rear Mounting Bracket	4	8mm x 28mm OD x 3mm Large Flat Washers
1	Passenger/Right Rear Mounting Bracket	8	8mm x 24mm OD x 2mm Standard Flat Washers
1	4mm Allen Tool	8	6-1.0mm x 25mm Button Head Allen Bolts
4	10-1.5mm x 35mm Hex Bolts	8	6mm Nylon Lock Nuts
4	10mm Nut Plates	8	6mm x 18mm OD x 1.6mm Flat Washers
4	10mm Lock Washers	8	6mm x 22mm OD x 2mm Large Flat Washers

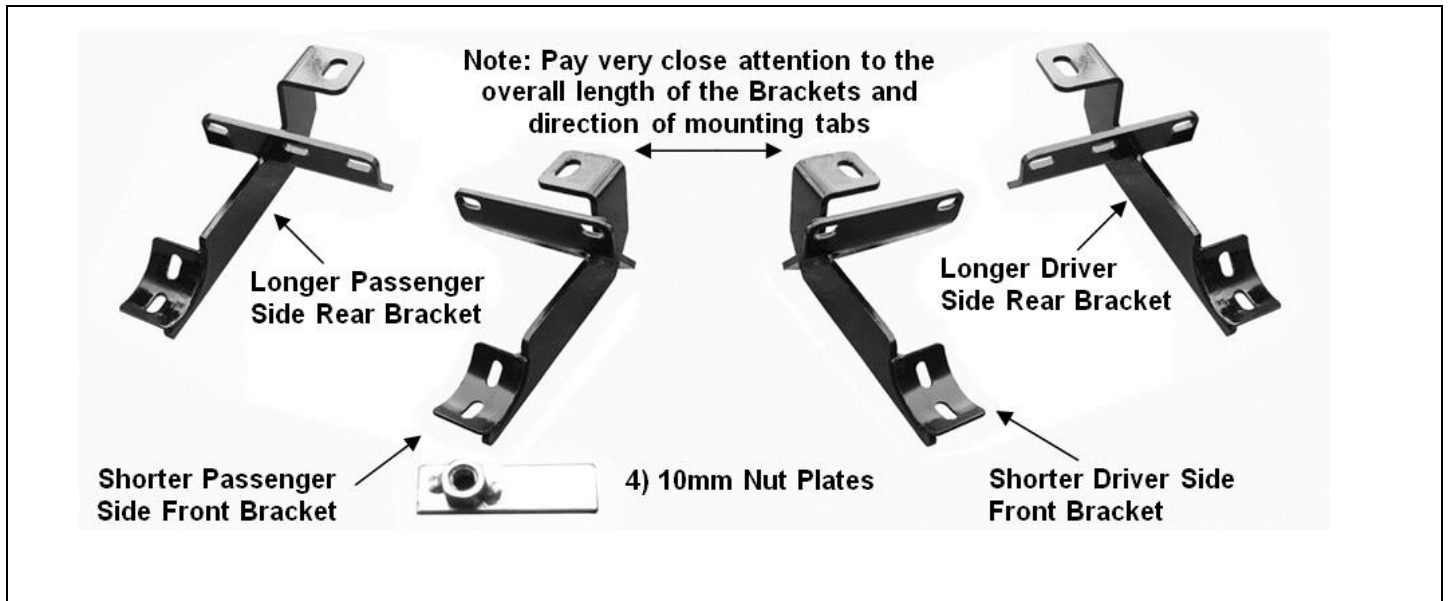

INSTALLATION PROCEDURE

1. Start installation toward the front of the driver side of the vehicle. Determine if the vehicle has an open floor panel or a threaded hole in the floor panel for the top tab on the Bracket, **(Figures 1 & 3)**.
 - a. **Vehicles open mounting location:** Insert (1) 10mm Nut Plate into the large square opening in the floor panel. Line up the threaded nut with the small hole in line with the tab on the Bracket, **(Figures 2A & 2B)**. Bolt the Bracket to the Nut Plate with (1) 10mm x 35mm Hex Bolt, (1) 10mm Lock Washer and (1) 10mm Flat Washer. Do not tighten hardware, **(Figure 4)**.
 - b. **Vehicles with factory threaded hole in floor panel:** Bolt the tab on the Bracket to the threaded hole in the floor panel with (1) 8mm x 35mm Hex Bolt, (1) 8mm Lock Washer and (1) 8mm x 28mm OD Large Flat Washer, **(Figures 3 & 4)**. Do not tighten hardware.
2. Line up the mounting plate on the Bracket with the (2) factory holes in the pinch weld. Bolt the Mounting Bracket to the **back** of the pinch weld using the included (2) 6mm x 25mm Button Head Allen Bolts, (2) 6mm x 18mm Small Flat Washers, (against pinch weld), (2) 6mm x 22mm OD Large Flat Washers, (inside against the bracket) and (2) 6mm Nylon Lock Nuts, **(Figure 4)**. Leave loose at this time.

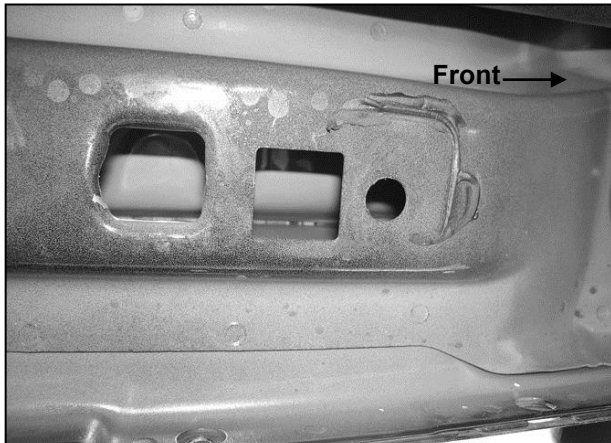

(Fig 1) 2007-10 driver side front mounting location

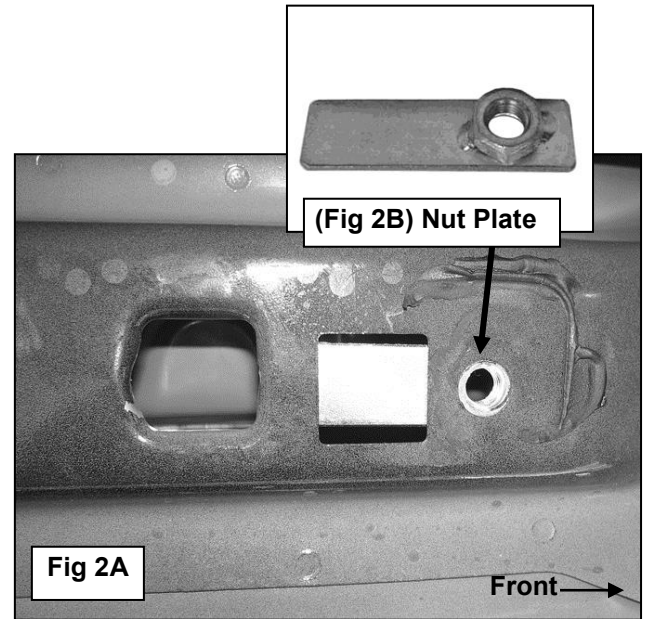

Vehicles with threaded hole in body panel use:
 8mm x 35mm Hex Bolt
 8mm Large Flat washer
 8mm Lock Washer

6mm x 25mm Allen Bolt,
 6mm x 18mm Small Flat Washer (outer)
 6mm ID x 23mm Large Flat Washer (inner)
 6mm Nylon Lock Nut

(1)10mm x 35mm Hex Bolt
 (1)10mm Flat Washer
 (1)10mm Lock Washer

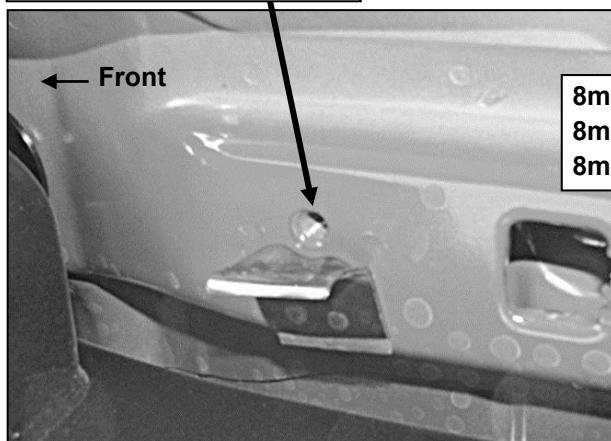

(Fig 3) 2011-12 threaded hole-Nut Plate not required

8mm x 25mm Hex Bolts
 8mm Flat washers
 8mm Lock Washers

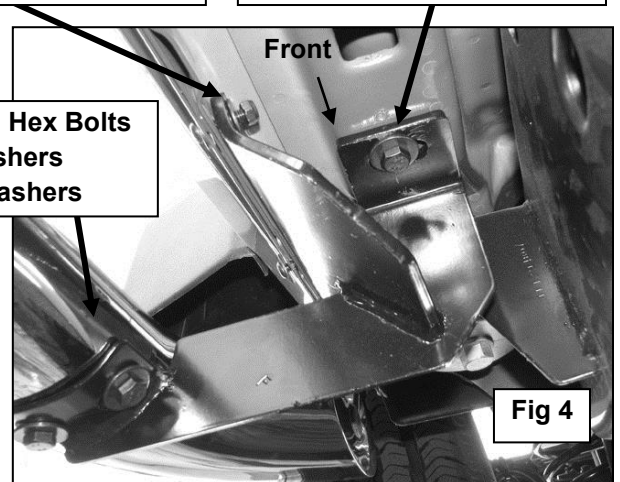
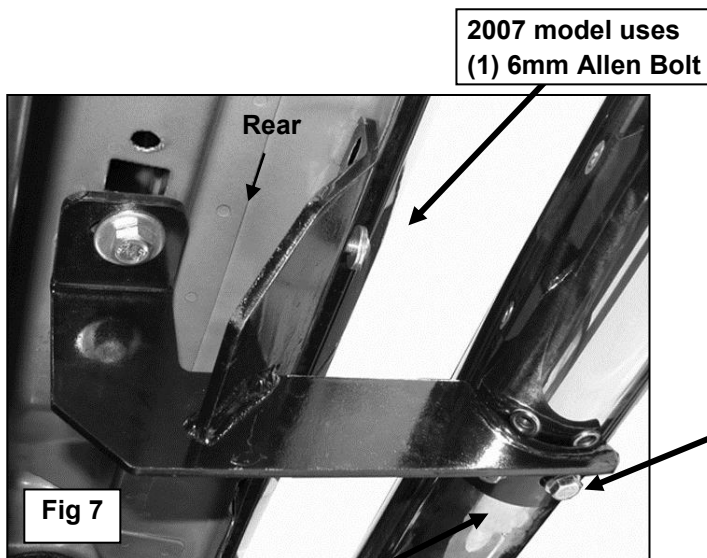
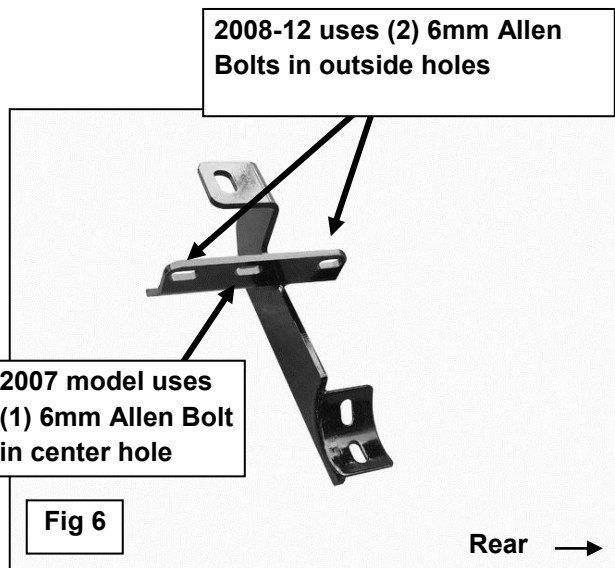
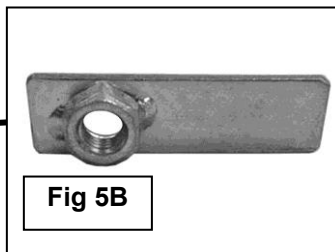
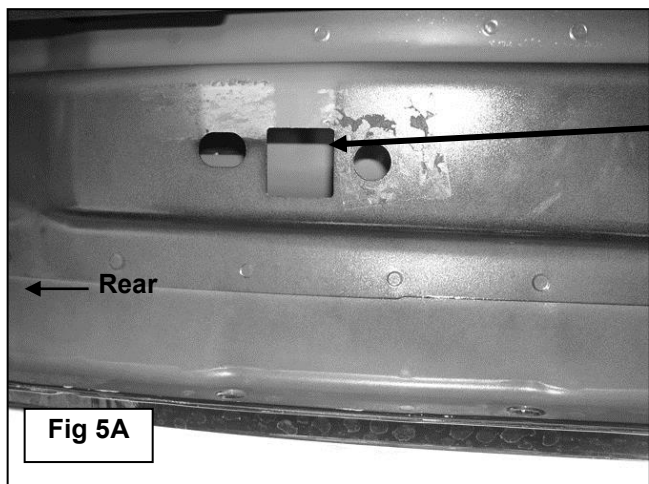

Fig 4

3. Repeat **Steps 1 - 2** for driver side rear Mounting Bracket installation, (**Figures 3, 5A & 5B**). **NOTE:** Determine correct rear Bracket installation procedure for your model year:
 - a. **2007 - 8:** Use only the center hole on the Bracket and (1) 6mm x 25mm Allen Bolt, (1) 6mm Small Flat Washer (outside) and (1) 6mm Large Flat Washer, (inside against bracket), and (1) 6mm Nylon Lock Nut to attach rear bracket to the back of the pinch weld, (**Figures 6 & 7**).
 - b. **2008 - 12:** Requires (2) 6mm Allen Bolts, (2) 6mm Small Flat Washers (outside) and (2) 6mm Large Flat Washers, (inside against bracket), and (2) 6mm Nylon Lock Nuts to attach rear bracket to back of pinch weld, (**Figures 6 & 8**).
4. Carefully unwrap and position the driver Sidebar onto the Brackets. Attach the Sidebar to the Mounting Brackets using the included (4) 8mm x 25mm Hex Bolts, (4) 8mm Lock Washers and (4) 8mm Flat Washers (**Figure 4**). Do not tighten at this time. **NOTE:** The Sidebar has (2) sets of inserts to bolt the Sidebar to the rear Bracket.
 - a. **2007:** Use the rear set of inserts closest to the rear tire, (**Figure 7**).
 - b. **2008 - 12:** Use the forward set of inserts, (**Figure 8**).



8mm x 25mm Hex Bolts
8mm Flat washers
8mm Lock Washers

Vehicles with threaded hole in body panel use:
8mm x 35mm Hex Bolt
8mm Large Flat washer
8mm Lock Washer

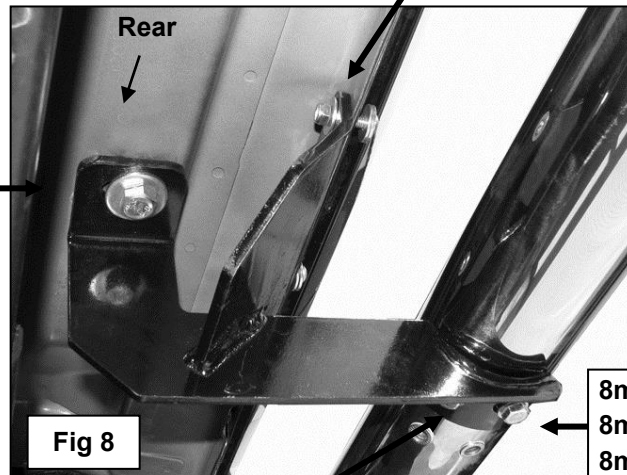

2008-12 uses (2)
6mm Allen Bolts

8mm x 25mm Hex Bolts
8mm Flat washers
8mm Lock Washers

2008 - 12 model uses forward
mounting holes on Sidebar

5. Level and adjust the Side Bar and Brackets and tighten all hardware.
6. Repeat **Steps 1 - 5** for Passenger Sidebar installation.



PARTS IDENTIFICATION GUIDE

Driver Side tube packed using "Green" color foam sheet. Passenger Side tube packed using "White" color foam sheet

No.	Parts Identification
1	Passenger / Right 'Rear' Bracket marked "PR"
2	Driver / Left 'Rear' Bracket marked "DR"
3	Passenger / Right 'Center' Bracket marked "PC"
4	Driver / Left 'Center' Bracket marked "DC"
5	Passenger / Right 'Front' Bracket marked "PF"
6	Driver / Left 'Front' Bracket marked "DF"

Note:

- This guide is to identify the parts and not a reference for part count.
- For part count, refer Parts List.
- Product / Bracket image is representative and actual design may vary.

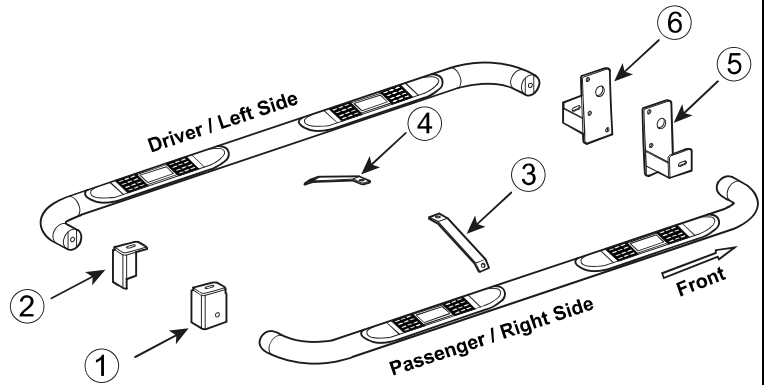

PRODUCT CARE

- Periodically check the product to ensure all fasteners are tight and components are intact.
- Regular waxing is recommended to protect the finish of the product.
- **Use ONLY Non-Abrasive automotive wax.** Use of any soap, polish or wax that contains an abrasive is detrimental and can scratch the finish leading to corrosion.
- Aluminum polish may be used to polish small scratches and scuffs for **Stainless Steel finish.**
- Mild soap may be used to clean the product for both **Stainless Steel and Black finish.**

FAQ's

1. Hardware's are not of correct size.

In GMC / Chevrolet truck model 2006 & up, customer needs to reuse the factory body bolts to install the bracket. If your vehicle is not GMC / Chevrolet 2006 & up, ensure that holes are not partially covered with any plastic grommet or rust? If it is, remove the plastic grommet & rust from the thread holes & re-try the installation.

2. Mounting Bracket are not getting Installed properly.

In some cases Illustration images shown in Installation manual may not be the exactly same as per actual vehicle images ,also if Driver / Passenger side mounting brackets are very identical in the design, suggest referring Parts Identification guide to avoid fitment issue.

3. Products are thumping / rattling after installation.

Ensure that all required mounting brackets / hardware's are installed & tighten correctly. Suggest using white lithium / regular grease between the metal to metal contact surfaces.

4. Side Bar is not aligning with vehicle / Step Pads are not aligning with vehicle doors.

Side bar may be interchanged or mounting brackets are not installed at the correct position in the vehicle. Refer Parts identification guide.

5. Missing / Excess Hardware.

Recheck hardware count as per the part list.

6. Product not installing properly.

Ensure make model year, cab length and bed size of your vehicle is listed in the application. All installation steps are followed correctly.