

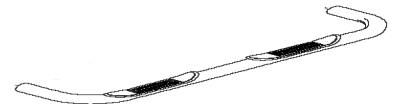

# 3" Side Bar

Part No. 1150522051/3



Fits: 2005-Current

Toyota Tacoma Double Cab



60-180 min

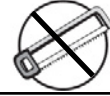

CUTTING NOT REQUIRED



DRILLING NOT REQUIRED



REMOVE CONTENTS FROM BOX. VERIFY ALL PARTS ARE PRESENT.



READ INSTRUCTIONS CAREFULLY BEFORE STARTING INSTALLATION.

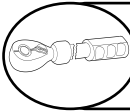

DO NOT OVER TORQUE. STANDARD OPERATING LOAD FOR TIGHTEN BODY MOUNT NUTS & BOLTS VARIES FROM 45 TO 65 FOOT POUND.

### PARTS LIST:

Qty	Part Description	Qty	Part Description
1	Driver Sidebar	1	Driver/Left Rear Mounting Bracket
1	Passenger Sidebar	1	Passenger/Right Rear Mounting Bracket
1	Driver/Left Front Mounting Bracket	24	8-1.25mm x 30mm Hex Bolts
1	Passenger/Right Front Mounting Bracket	24	8mm Lock Washers
1	Driver/Left Middle Mounting Bracket	24	8mm ID x 24mm OD x 2mm Flat Washers
1	Passenger/Right Middle Mounting Bracket		

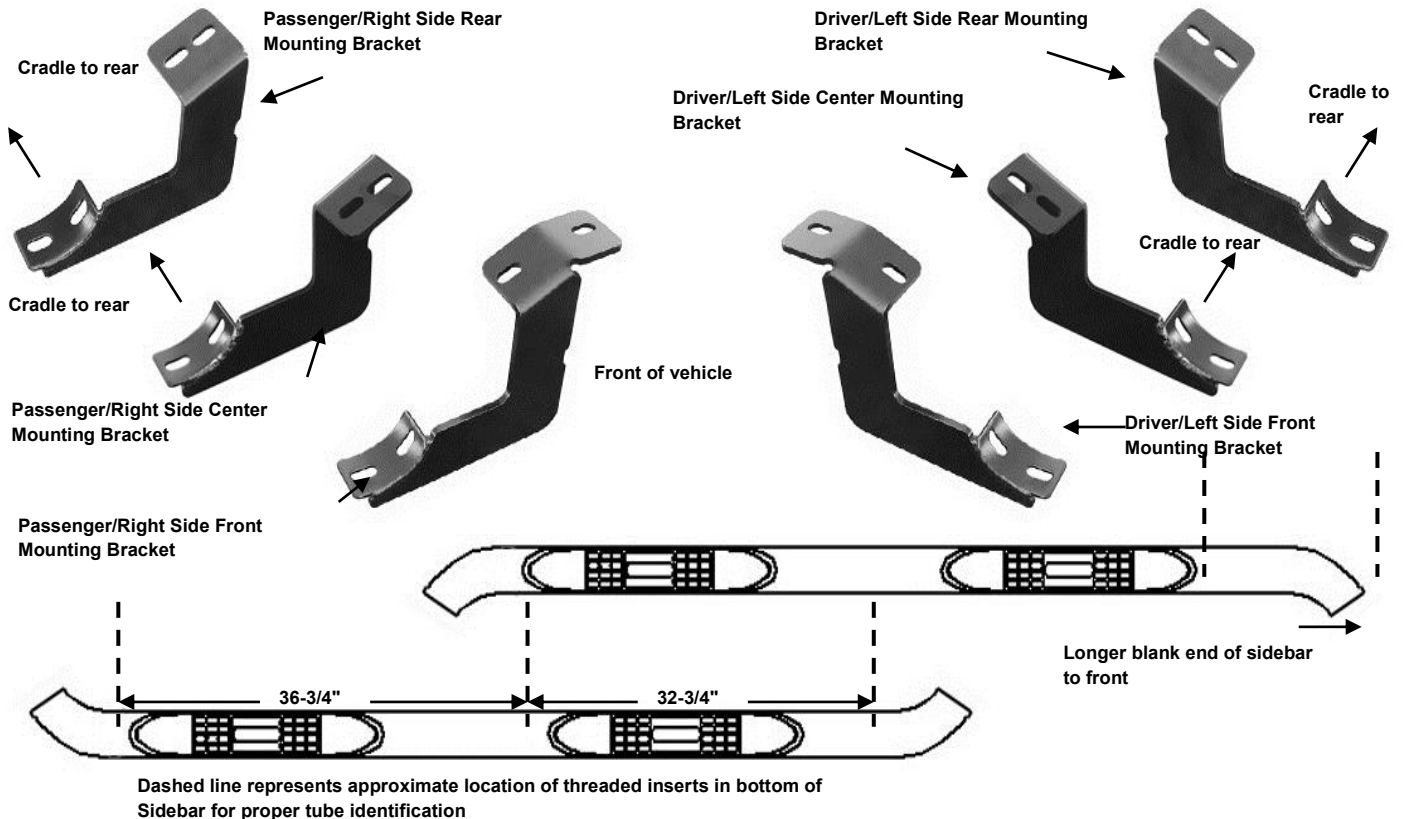

## INSTALLATION PROCEDURE

1. Starting on the driver side front of the vehicle, use a flat screw driver to remove the plastic plugs covering the threaded holes in the body panel, (**Figure 1**). Select the driver side front Mounting Bracket and bolt it to the vehicle using the included (2) 8mm Hex Bolts, (2) 8mm Lock Washers and (2) 8mm Flat Washers, (**Figure 2**). Do not tighten hardware at this time.

### Driver Side Installation Pictured

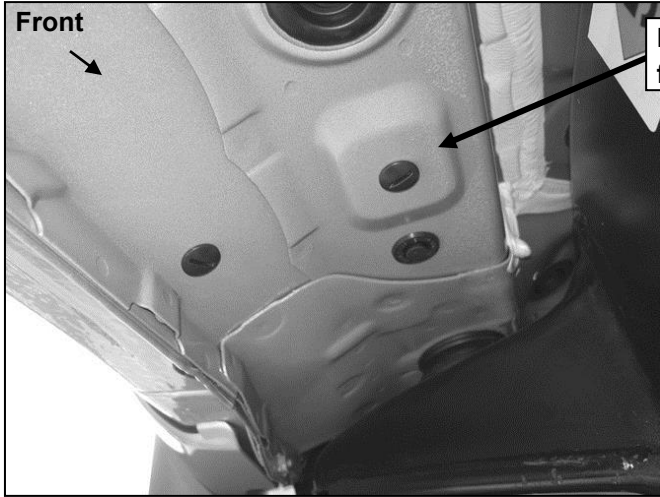

Remove plastic plugs or factory hex bolts (if equipped)

(2) 8mm x 30mm Hex Bolts  
(2) 8mm Flat Washers  
(2) 8mm Lock Washers

(Fig 1) Driver side front mounting location pictured

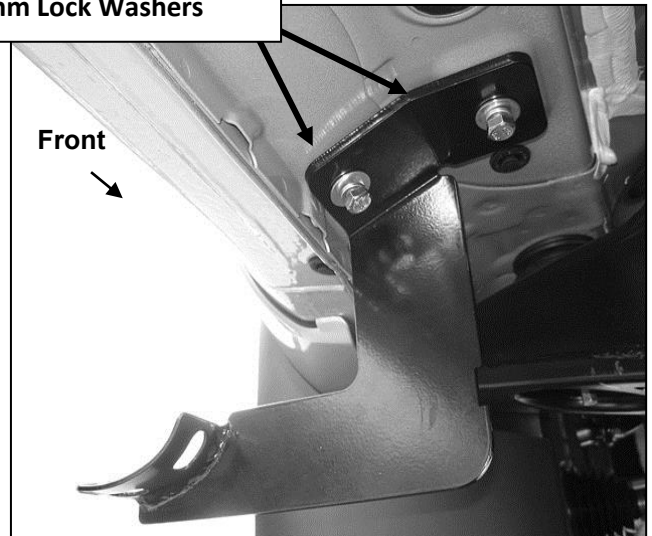

(Fig 2) Driver side front mounting location pictured

2. Repeat Step 2 for center and rear Mounting Bracket installation, (**Figures 3 & 4**).

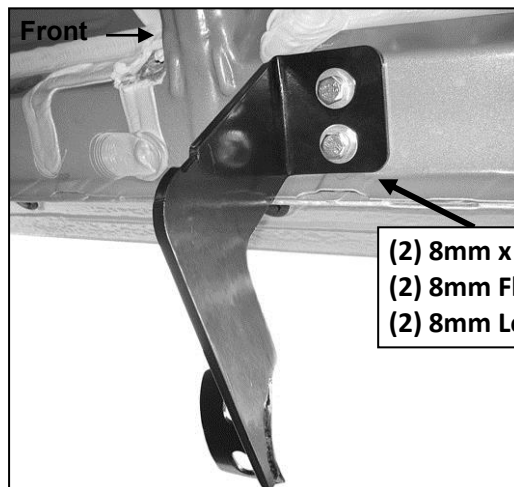

(2) 8mm x 30mm Hex Bolts  
(2) 8mm Flat Washers  
(2) 8mm Lock Washers

(Fig 3) Driver side center mounting location pictured

3. **IMPORTANT:** Use the illustration on this page to identify the sidebars before continuing with the installation. Verify that the Brackets are in the correct locations as illustrated above. Carefully place the driver Sidebar onto the Brackets. Align the inserts in the bottom of the Sidebar with the slots on the Mounting Brackets. Attach the Sidebar to the Mounting Brackets with the included (6) 8mm Hex Bolts, (6) 8mm Lock Washers and (6) 8mm Flat Washers, (Figure 4). Do not tighten hardware at this time.
4. Level and adjust the Sidebar properly and tighten all hardware.
5. Repeat Steps 2 - 5 for passenger Sidebar installation.
6. Do periodic inspections to the installation to make sure that all hardware is secure and tight.

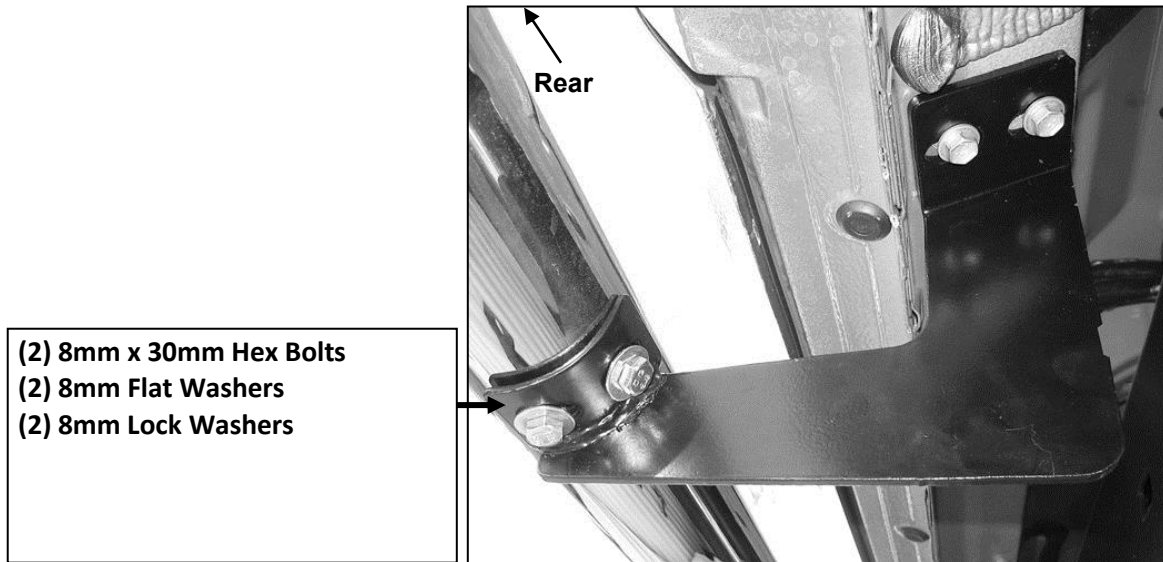

(Fig 4) Driver side rear mounting location pictured

## PARTS IDENTIFICATION GUIDE

*Driver Side tube packed using "Green" color foam sheet. Passenger Side tube packed using "White" color foam sheet*

No.	Parts Identification
1	Passenger / Right 'Rear' Bracket marked "PR"
2	Driver / Left 'Rear' Bracket marked "DR"
3	Passenger / Right 'Center' Bracket marked "PC"
4	Driver / Left 'Center' Bracket marked "DC"
5	Passenger / Right 'Front' Bracket marked "PF"
6	Driver / Left 'Front' Bracket marked "DF"

### Note:

- This guide is to identify the parts and not a reference for part count.
- Product / Bracket image is for representative purpose only.
- Actual design may vary based on application.
- Refer Installation Instructions for Hardware Kit detail.

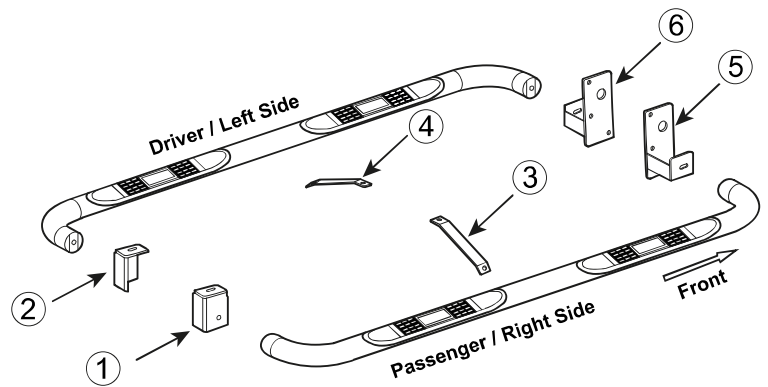

## PRODUCT CARE

- Periodically check the product to ensure all fasteners are tight and components are intact.
- Regular waxing is recommended to protect the finish of the product.
- **Use ONLY Non-Abrasive automotive wax.** Use of any soap, polish or wax that contains an abrasive is detrimental and can scratch the finish leading to corrosion.
- Aluminum polish may be used to polish small scratches and scuffs for **Stainless Steel finish.**
- Mild soap may be used to clean the product for both **Stainless Steel and Black finish.**

## FAQ's

1. **Hardware's are not of correct size.**  
In GMC / Chevrolet truck model 2006 & up, customer needs to reuse the factory body bolts to install the bracket. If your vehicle is not GMC / Chevrolet 2006 & up, please ensure that holes are not partially covered with any plastic grommet or rust? If it is, please remove the plastic grommet & rust from the thread holes & re-try the installation.
2. **Mounting Bracket are not getting Installed properly.**  
In some cases Illustration images shown in Installation manual may not be the exactly same as per actual vehicle images ,also if Driver / Passenger side mounting brackets are very identical in the design, suggest referring Parts Identification guide to avoid fitment issue.
3. **Products are thumping / rattling after installation.**  
Please ensure that all required mounting brackets / hardware's are installed & tighten correctly. Suggest using white lithium / regular grease between the metal to metal contact surfaces.
4. **Side Bar is not aligning with vehicle / Step Pads are not aligning with vehicle doors.**  
Side bar may be interchanged or mounting brackets are not installed at the correct position in the vehicle. Please refer Parts identification guide.
5. **Missing / Excess Hardware.**  
Recheck hardware count as per the part list.
6. **Product not installing properly.**  
Ensure make model year, cab length and bed size of your vehicle is listed in the application. All installation steps are followed correctly.