



# 3" Side Bar

Part No.1130301091/1130301093



Fits: 2009 - Current

Ford F150 Regular Cab



60-180 min

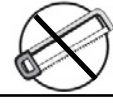

Cutting Not Required



Drilling Required



REMOVE CONTENTS FROM BOX. VERIFY ALL PARTS ARE PRESENT.



READ INSTRUCTIONS CAREFULLY BEFORE STARTING INSTALLATION.

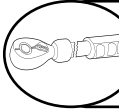

DO NOT OVER TORQUE. STANDARD OPERATING LOAD FOR TIGHTEN BODY MOUNT NUTS & BOLTS VARIES FROM 45 TO 65 FOOT POUND.

### PARTS LIST:

Qty	Part Description	Qty	Part Description
1	Driver/Left Sidebar	4	1/2" Lock Washers
1	Passenger/Right Sidebar	4	12mm x 32mm OD x 3mm Flat Washers
1	Driver/Left Front Mounting Bracket	4	12mm Lock Washers
1	Passenger/Right Front Mounting Bracket	4	12mm Hex Nuts
2	Support Brackets	4	10-1.50mm x 30mm Hex Bolts
1	Driver/Left Top Mounting Bracket	4	10-1.50mm x 35mm Hex Bolts
1	Passenger/Right Top Mounting Bracket	6	10mm x 30mm OD x 2.5mm Flat Washers
1	Driver/Left Rear Mounting Bracket	8	10mm x 20mm OD x 2mm Flat Washers
1	Passenger/Right Rear Mounting Bracket	8	10mm Lock Washers
2	12mm x 40mm x 10mm Nut and Bolt Plate	6	10mm Hex Nuts
2	12mm x 40mm Bolt Plates	4	8-1.25mm x 30mm Hex Bolts
4	12mm Plastic Retainers	4	8mm x 24mm OD x 2mm Flat Washers (Outer)
2	10mm Plastic Retainers	4	8mm x 16mm OD x 1.6mm Flat Washers (Inner)
4	1/2" x 2" Hex Bolts	4	8mm Lock Washers
4	1/2" x 1-1/4" OD x 3/32" Flat Washers	4	8mm Hex Nuts

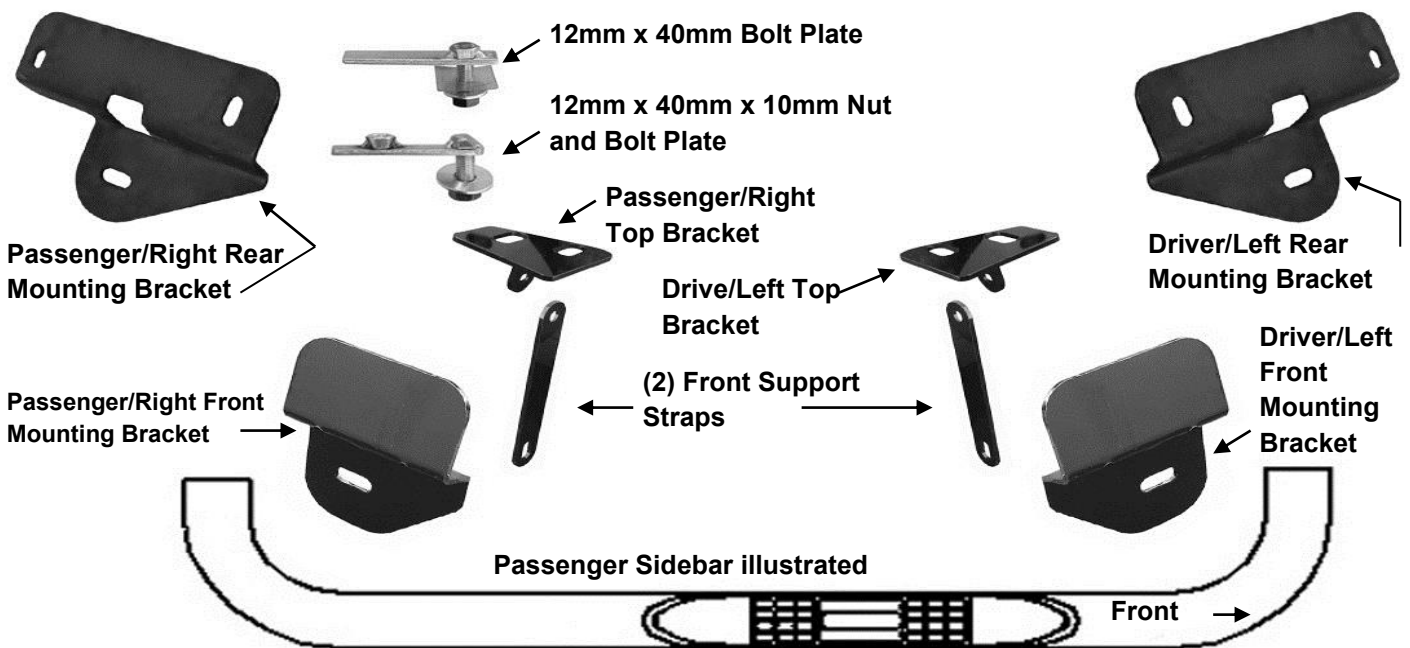

## INSTALLATION PROCEDURE

1. Starting at the front of the driver side of the vehicle, remove the two small hex bolts and the metal clips holding the bottom of the fender to the body, **(Figure 1A)**. **NOTE:** Use a small flat screwdriver to spread the clip apart for easy removal. Due to body panel misalignment from the factory, it may be necessary to open these holes slightly with a 3/8" drill bit, **(Figure 1B)**.
2. Select the driver side front Mounting Bracket. Line up the (2) holes in the pinch weld with the holes in the front Mounting Bracket. Insert (2) 8mm x 30mm Hex Bolts with (2) 8mm x 24mm OD x 2mm Large Flat Washers up from below and secure with (2) 8mm x 16mm OD x 1.6mm Small Flat Washers, (to clear the bracket), (2) 8mm Lock Washers and (2) 8mm Hex Nuts, **(Figure 2)**. Do not tighten hardware at this time.

### Driver Side Installation Pictured

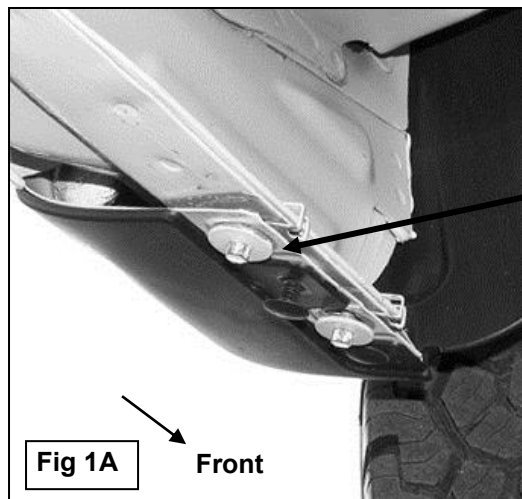

Remove these two hex bolts and metal clip nuts. Drill a 3/8" hole through the pinch weld to clearance holes **ONLY** if necessary

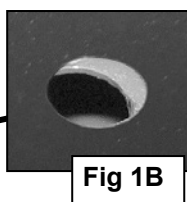

(2) 8mm x 30mm Hex Bolts  
(2) 8mm Lock Washers  
(2) 8mm x 24mm Large Flat Washers (outer)  
(2) 8mm x 16mm Small Flat Washers (inner against Bracket)  
(2) 8mm Hex Nuts

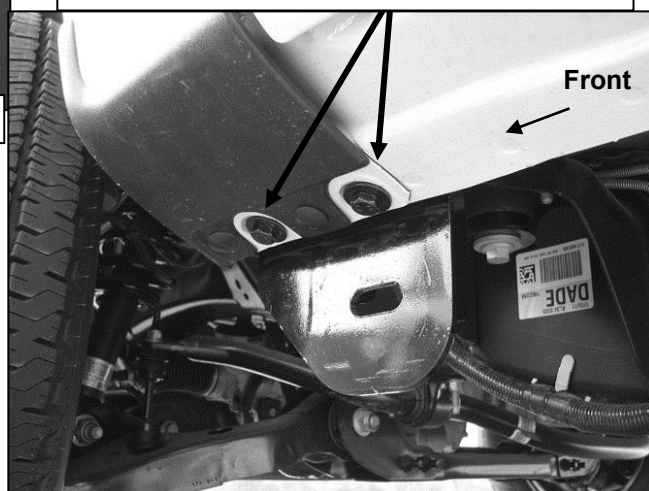

(Fig 2) Driver side front Mounting Bracket pictured

1. Next, locate the round and square holes in the floor panel next to the body mount. Select (1) 12mm x 40mm x 10mm Nut and Bolt Plate and thread (1) 12mm Plastic Retainer part way onto it, **(Figure 3A)**. Insert the Nut and Bolt Plate into the square hole in the floor, **(Figure 3B)**. Line up the nut on the Nut and Bolt Plate with the round hole. **IMPORTANT:** The Plastic Retainer is designed to prevent the Bolt Plate from falling into the body cavity and to aid in mounting the Bracket. After inserting, thread the Plastic Retainer down flush against the body panel. **NOTE:** For passenger side installation, temporarily remove the ground strap if interfering with install.

Insert the Nut and Bolt Plate into square hole and line up the nut with the round hole

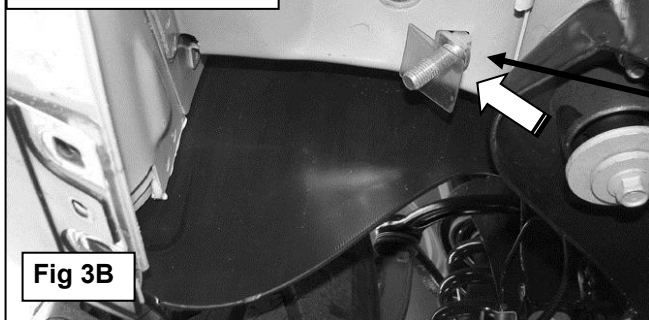

1. Select the driver side Top Bracket. Hold the Top Bracket in place over the Nut and Bolt Plate. Secure the Bracket to the Nut and Bolt Plate with (1) 12mm Flat Washer, (1) 12mm Lock Washer and (1) 12mm Hex Nut, **(Figure 4)**. Rotate the Nut and Bolt Plate to line up the Nut with the remaining hole and thread (1) 10mm x 35mm Hex Bolt, (1) 10mm x 30mm OD Large Flat Washer and (1) 10mm Lock Washer into the Nut, **(Figure 5)**. Do not tighten hardware.

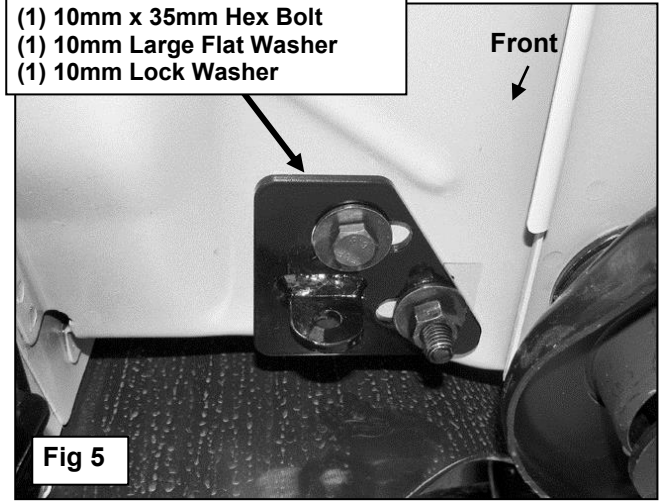
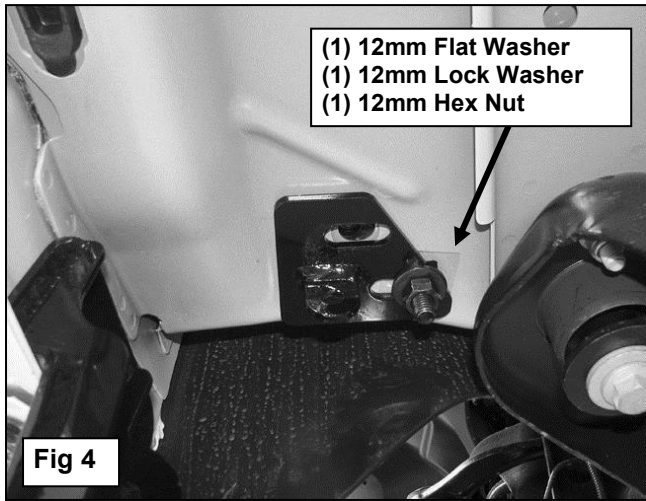

1. Select (1) Support Strap. Bolt the round hole on the Support Strap to the backside of the tab on the Top Bracket with (1) 10mm x 30mm Hex Bolt, (2) 10mm x 20mm x 2mm Small Flat Washers, (1) 10mm Lock Washer and (1) 10mm Hex Nut, **(Figure 6)**. Line up the slotted end of the Support Bracket with the tab on the back of the Mounting Bracket with the Support Strap on the forward facing side of the tab. Bolt the Strap to the tab with (1) 10mm x 30mm Hex Bolt, (2) 10mm x 20mm x 2mm Small Flat Washers, (1) 10mm Lock Washer and (1) 10mm Hex Nut, **(Figure 6)**. Do not tighten hardware at this time.

1. Move toward the rear of the vehicle and remove the tape covering the holes on the inner body panel. Select (1) 12mm Bolt Plate and thread (1) 12mm Plastic Retainer part way onto it, **(Figure 7A)**. Insert the Bolt Plate and Retainer into the rear mounting hole, **(Figure 7B)**, as described in **Step 3**.

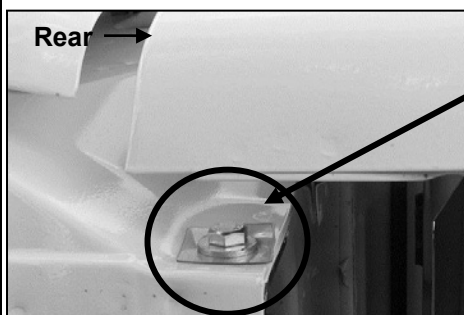
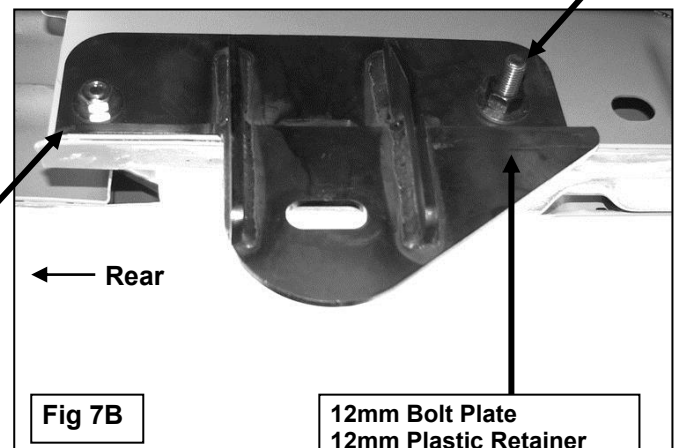
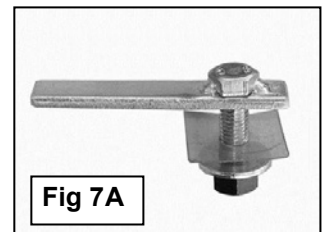
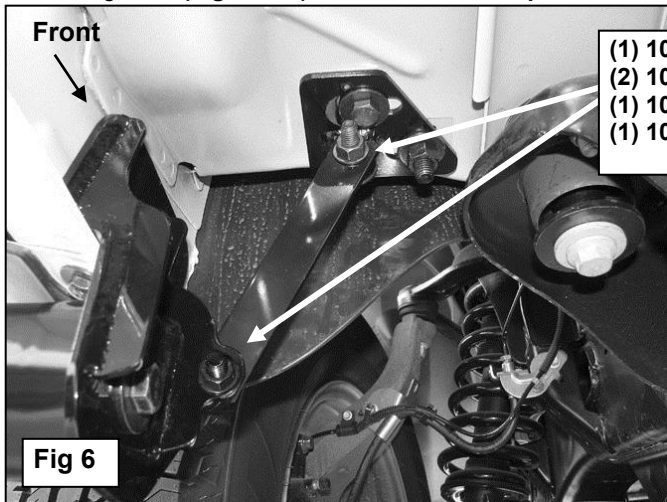

**(Fig 8B)** Rear bolt on Rear Mounting Bracket pictured from outside of vehicle. Place the Plastic Washer between the 10mm Flat Washer and the painted surface of the truck body

1. Hang the driver side Rear Mounting Bracket from the Bolt Plate and secure it with the included (1) 12mm Lock Washer, (1) 12mm Flat Washer, and (1) 12mm Hex Nut, **(Figure 7B)**. Insert (1) 10mm x 35mm Hex Bolt, (1) 10mm x 30mm OD Large Flat Washer with (1) 10mm Plastic Retainer into the hole at the rear of the Mounting Bracket from the outside-in, **(Figures 8A & 8B)**. **NOTE:** The Plastic Retainer is intended to protect the outer painted surface of the body. Thread the Plastic Retainer onto the Hex Bolt so that it is between the 10mm Large Flat Washer and the body. Secure the Bracket with (1) 10mm Lock Washer, (1) 10mm x 30mm Large Flat Washer and (1) 10mm Hex Nut. Do not tighten hardware at this time.
2. Attach the Sidebar to the Mounting Brackets using the included (2) 1/2" x 2" Hex Bolts, (2) 1/2" Flat Washers, and (2) 1/2" Lock Washers, **(Figure 9)**. Do not tighten hardware at this time.
3. Align the Sidebar and adjust as required. Once properly aligned, tighten all hardware.
4. Repeat Steps 1 - 9 for passenger Sidebar installation. **NOTE:** Once passenger side installation is completed, reinstall the ground strap next to the mounting holes for the front Mounting Bracket as removed in **Step 3**.
5. Do periodic inspections to the installation to make sure that all hardware is secure and tight.

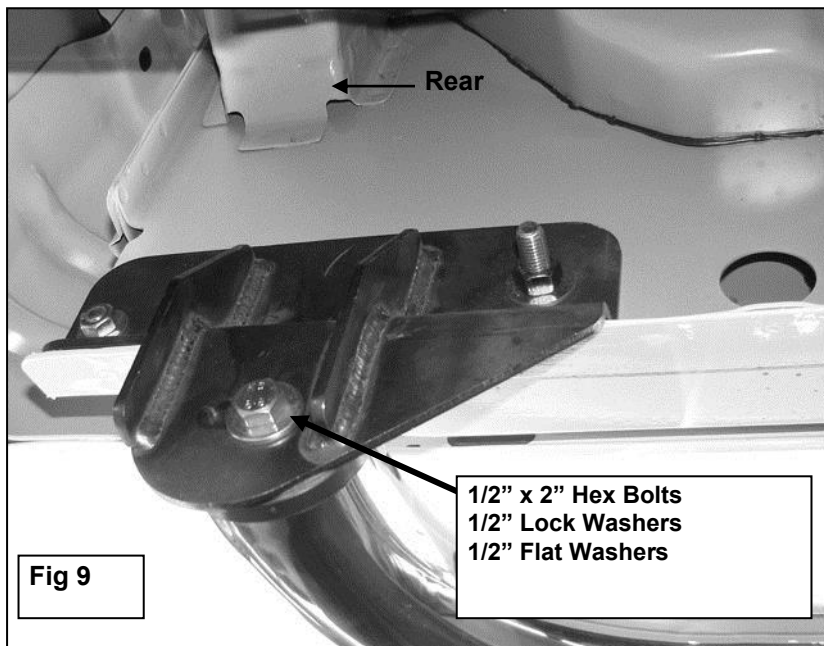

## PARTS IDENTIFICATION GUIDE

**Driver Side tube packed using "Green" color foam sheet. Passenger Side tube packed using "White" color foam sheet**

No.	Parts Identification
1	Passenger / Right 'Rear' Bracket marked "PR"
2	Driver / Left 'Rear' Bracket marked "DR"
3	Passenger / Right 'Center' Bracket marked "PC"
4	Driver / Left 'Center' Bracket marked "DC"
5	Passenger / Right 'Front' Bracket marked "PF"
6	Driver / Left 'Front' Bracket marked "DF"

### Note:

- This guide is to identify the parts and not a reference for part count.
- For part count, refer Parts List.
- Product / Bracket image is representative and actual design may vary.

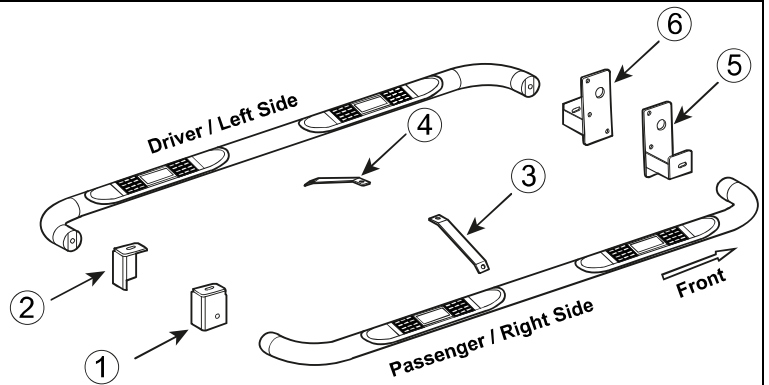

## PRODUCT CARE

- Periodically check the product to ensure all fasteners are tight and components are intact.
- Regular waxing is recommended to protect the finish of the product.
- **Use ONLY Non-Abrasive automotive wax.** Use of any soap, polish or wax that contains an abrasive is detrimental and can scratch the finish leading to corrosion.
- Aluminum polish may be used to polish small scratches and scuffs for **Stainless Steel finish.**
- Mild soap may be used to clean the product for both **Stainless Steel and Black finish.**

## FAQ's

### 1. Hardware's are not of correct size.

*In GMC / Chevrolet truck model 2006 & up, customer needs to reuse the factory body bolts to install the bracket. If your vehicle is not GMC / Chevrolet 2006 & up, ensure that holes are not partially covered with any plastic grommet or rust? If it is, remove the plastic grommet & rust from the thread holes & re-try the installation.*

### 2. Mounting Bracket are not getting Installed properly.

*In some cases Illustration images shown in Installation manual may not be the exactly same as per actual vehicle images ,also if Driver / Passenger side mounting brackets are very identical in the design, suggest referring Parts Identification guide to avoid fitment issue.*

### 3. Products are thumping / rattling after installation.

*Ensure that all required mounting brackets / hardware's are installed & tighten correctly. Suggest using white lithium / regular grease between the metal to metal contact surfaces.*

### 4. Side Bar is not aligning with vehicle / Step Pads are not aligning with vehicle doors.

*Side bar may be interchanged or mounting brackets are not installed at the correct position in the vehicle. Refer Parts identification guide.*

### 5. Missing / Excess Hardware.

*Recheck hardware count as per the part list.*

### 6. Product not installing properly.

*Ensure make model year, cab length and bed size of your vehicle is listed in the application. All installation steps are followed correctly.*