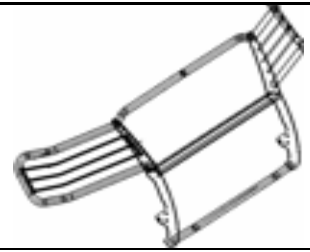




# Grille Guard

## Part No. E0027S/B



Fits: 2015- Current Ford Transit 150/250/350 Cargo Van (Full size)



REMOVE CONTENTS FROM BOX. VERIFY ALL PARTS ARE PRESENT.



60-180 min



CUTTING  
REQUIRED



DRILLING MAY BE  
REQUIRED



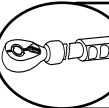
READ INSTRUCTIONS CAREFULLY BEFORE STARTING INSTALLATION.



support@trailfx.com



1 866 638 4870



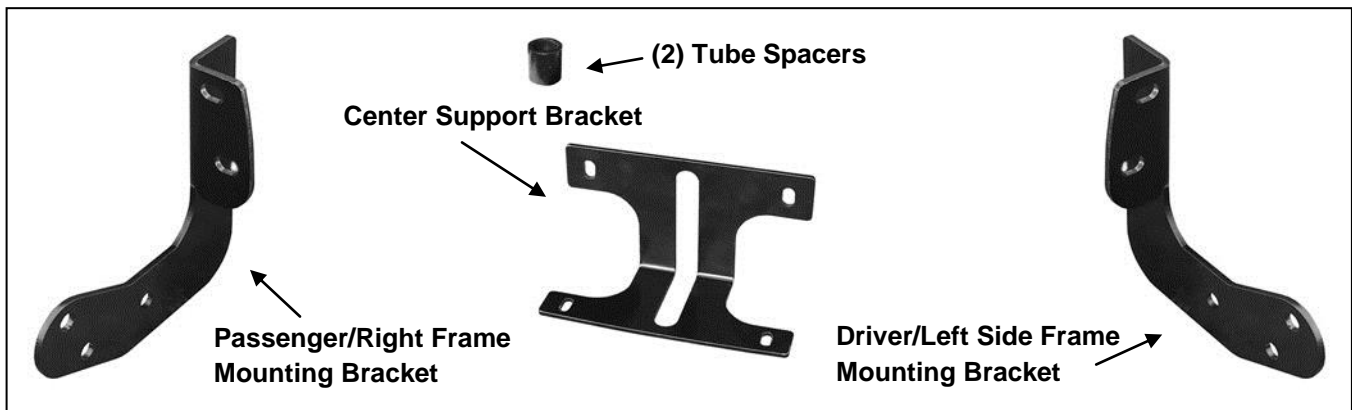
DO NOT OVER TORQUE. STANDARD OPERATING LOAD FOR TIGHTEN BODY MOUNT NUTS & BOLTS VARIES FROM 45 TO 65 FOOT POUND.



POLISHED STAINLESS STEEL – LIMITED LIFETIME  
POWDER COATED BLACK – 3 YEARS

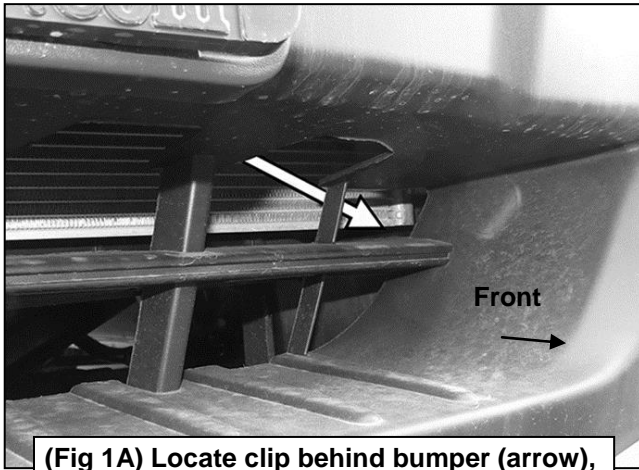
### PARTS LIST:

Qty	Part Description	Qty	Part Description
1	Front Runner Grille Guard Center	6	12mm Lock Washers
1	Driver/Left Modular Wing	6	12mm Hex Nuts
1	Passenger/Right Modular Wing	2	8-1.25mm x 40mm Hex Bolts
1	Driver/Left Frame Mounting Bracket	8	8-1.25mm x 30mm Hex Bolts
1	Passenger/Right Frame Mounting Bracket	18	8mm x 24mm OD x 2mm Flat Washers
1	Support Bracket	2	8mm Lock Washers
2	Tube Spacers	8	8-1.25mm Nylon Lock Nuts
6	12-1.75mm x 35mm Hex Bolts	2	6-1.0mm x 20mm Button Head Bolts
2	12mm x 32mm OD x 3mm Large Flat Washers	2	6mm x 18mm OD x 1.6mm Flat Washers
12	12mm x 24mm OD x 2.5mm STD Flat Washers	2	6mm Lock Washers
		3	ST6x20mm Phillips Head Screws

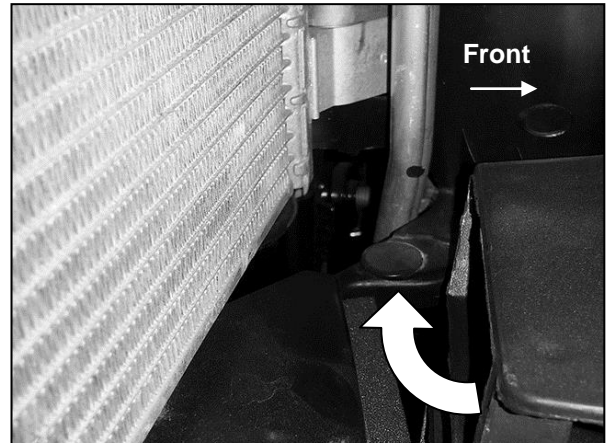


### PROCEDURE:

- ASSISTANCE IS RECOMMENDED.** Start installation under the front bumper. Locate the (2) plastic clips attaching the splash guard to the back of the opening in the bumper, (**Figures 1A & 1B**). **IMPORTANT:** Clips are located at each end of the bumper opening. Access the clips through the opening in the bumper. Use a flat blade screwdriver to carefully pry up the clips. Remove all of the factory hardware attaching the plastic splash guard to the bottom of the bumper, (**Figure 2**). Move splash guard to a clean stable surface.



(Fig 1A) Locate clip behind bumper (arrow), at each end of bumper opening

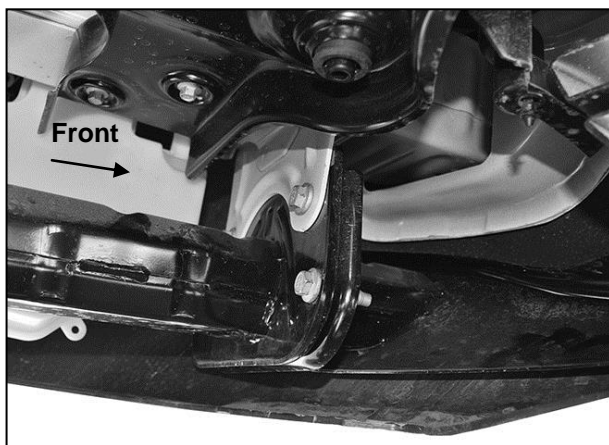


(Fig 1B) Locate clip at each end of bumper opening (driver side pictured from behind bumper)

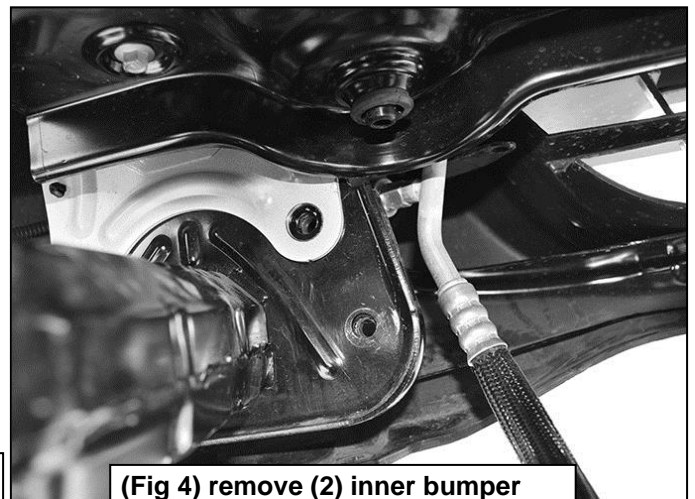


(Fig 2) Remove plastic splash guard

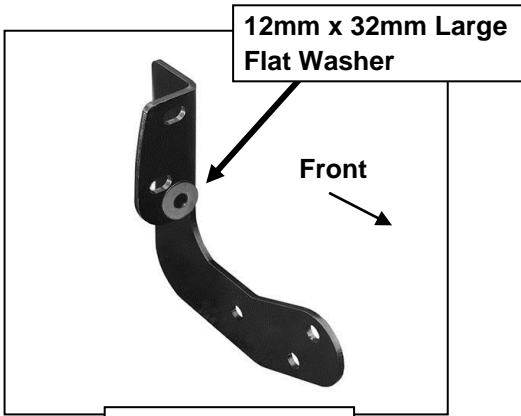
2. From under the front of the vehicle, remove the (2) inner factory hex bolts attaching the driver side bumper bracket to the end of the frame, (**Figures 3 & 4**). Select the driver side Frame Mounting Bracket, (**Figure 5**). Reuse (1) factory hex bolt to attach the Mounting Bracket to the top hole in the back of the bumper bracket. Leave loose at this time. Select (1) 12mm x 32mm Large Flat Washer, (**Figures 5 & 6A**). Use the Washer as a spacer on the bottom mounting hole, between the Mounting Bracket and the bumper bracket, (**Figure 6B**). Insert the factory hex bolt through the Mounting Bracket, Flat Washer and into the bumper bracket. Do not fully tighten hardware at this time.



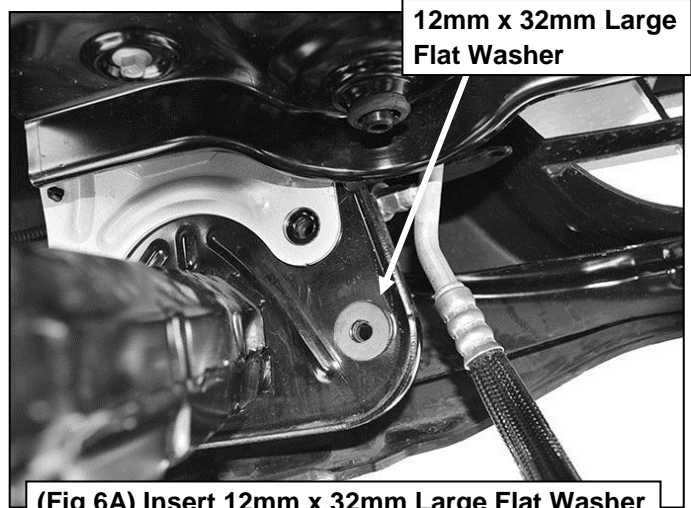
(Fig 3) Locate bumper bracket (driver side pictured)



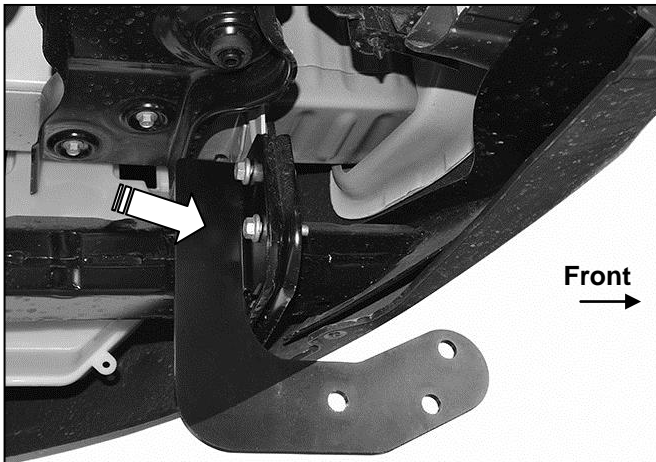
(Fig 4) remove (2) inner bumper bracket bolts (driver side pictured)



(Fig 5) Driver side Mounting Bracket



(Fig 6A) Insert 12mm x 32mm Large Flat Washer between Mounting Bracket and bumper bracket

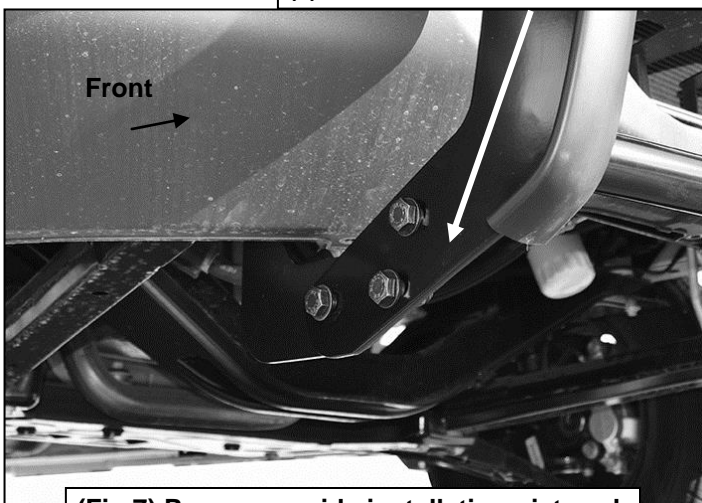


(Fig 6B) Use 12mm x 32mm Large Flat Washer for a spacer on lower mounting bolt only between Mounting Bracket and bumper bracket (Driver side Bracket installation pictured)

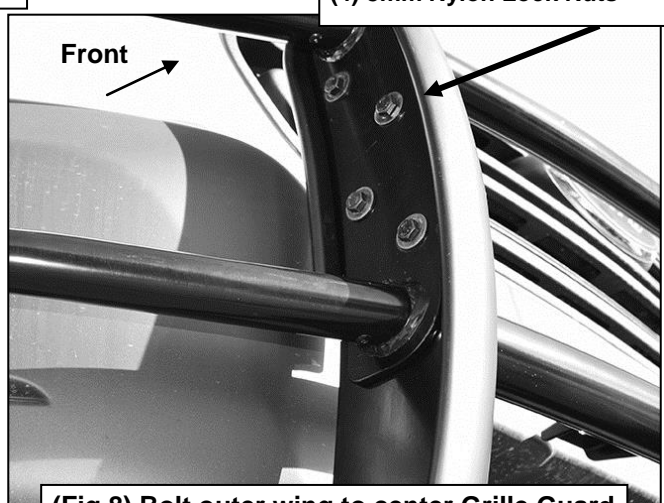
3. Repeat **Step 2** to install the passenger side Frame Mounting Bracket.
4. With assistance, place the Grille Guard up to the outside of the Frame Brackets. Attach the Grille Guard to the Brackets with (6) 12mm x 35mm Hex Bolts, (12) 12mm x 24mm STD Flat Washers, (6) 12mm Lock Washers and (6) 12mm Hex Nuts, (**Figure 7**). Snug but do not tighten hardware at this time.
5. Next, select the driver side outer wing. Attach the wing to the center Grille Guard with (4) 8mm x 30mm Hex Bolts, (8) 8mm Flat washers and (4) 8mm Nylon Lock Nuts, (**Figure 8**). Tighten wing hardware at this time. Repeat to attach the passenger side wing to the grille guard.

- (3) 12mm x 35mm Hex Bolts
- (6) 12mm x 24mm STD Flat Washers
- (3) 12mm Lock Washers
- (3) 12mm Hex Nuts

- (4) 8mm x 30mm Hex Bolts
- (8) 8mm Flat Washers
- (4) 8mm Nylon Lock Nuts

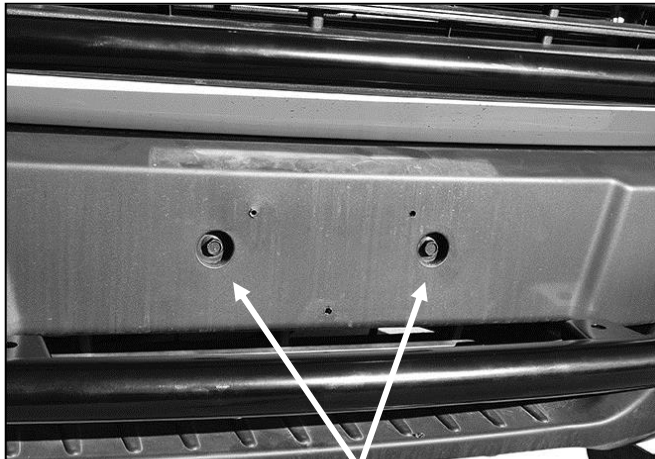


(Fig 7) Passenger side installation pictured



(Fig 8) Bolt outer wing to center Grille Guard (Passenger side installation pictured)

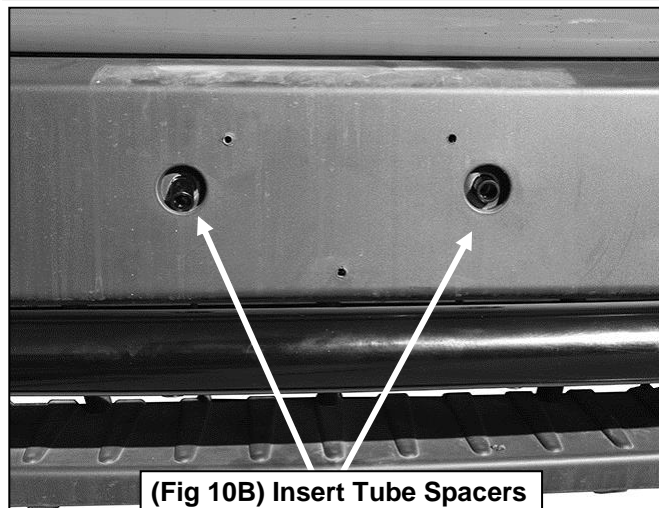
6. Next, remove the front license plate and license plate bracket, (if equipped). **IMPORTANT:** License plate bracket may be attached with rivets. Carefully drill out the center of the rivet. Do not enlarge the holes in the bumper.
7. Remove the (2) plastic plugs and hex bolts from the center of the bumper, (Figure 9). Select the (2) Tube Spacers, (Figure 10A). Insert the Spacers into the recess in the bumper, (Figure 10B).



(Fig 9) Remove license plate and bracket (if equipped). Remove (2) plastic plugs and hex bolts



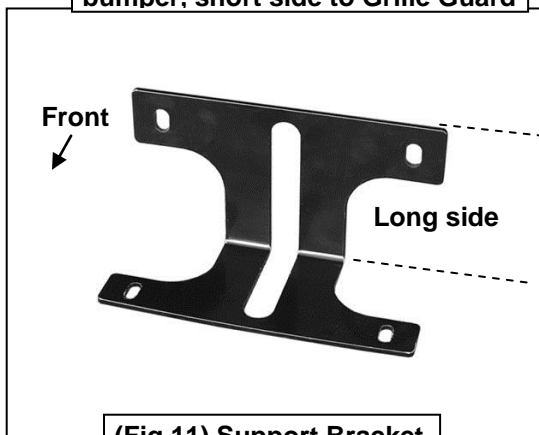
(Fig 10A) Tube Spacer



(Fig 10B) Insert Tube Spacers into recesses in bumper

8. Select the Front Support Bracket, (Figure 11). Hold the Bracket in position over the Tube Spacers. Insert (2) 8mm x 40mm Hex Bolts, (2) 8mm Lock Washers and (2) 8mm Flat Washers through the Bracket, Tube Spacers and into the bumper, (Figure 12). Leave loose at this time.

**NOTE: Attach long side to bumper, short side to Grille Guard**



(Fig 11) Support Bracket

**(2) 8mm x 40mm Hex Bolts  
(2) 8mm Lock Washers  
(2) 8mm Flat Washers  
Insert Bolts through Bracket, Tube Spacers then into bumper**

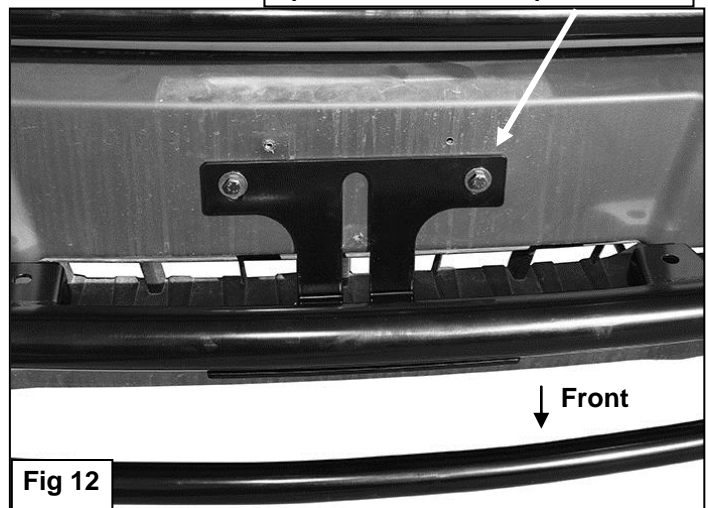
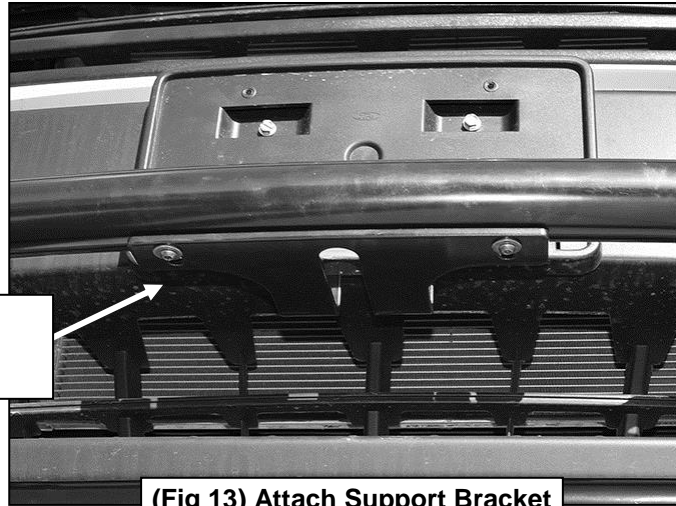


Fig 12

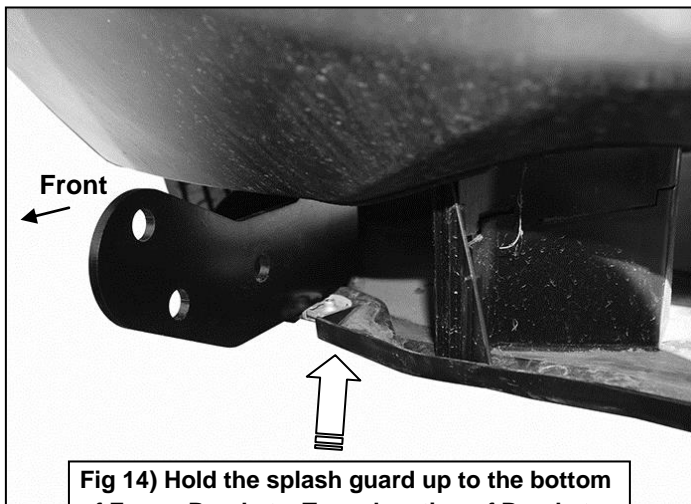
- Line up the bottom of the Support Bracket with the threaded inserts in the bottom of the crossbar. Attach the Bracket to the crossbar with (2) 6mm x 20mm Button Head Bolts, (2) 6mm Lock Washers and (2) 6mm Flat Washers, **(Figure 13)**. Snug but do not fully tighten hardware at this time.



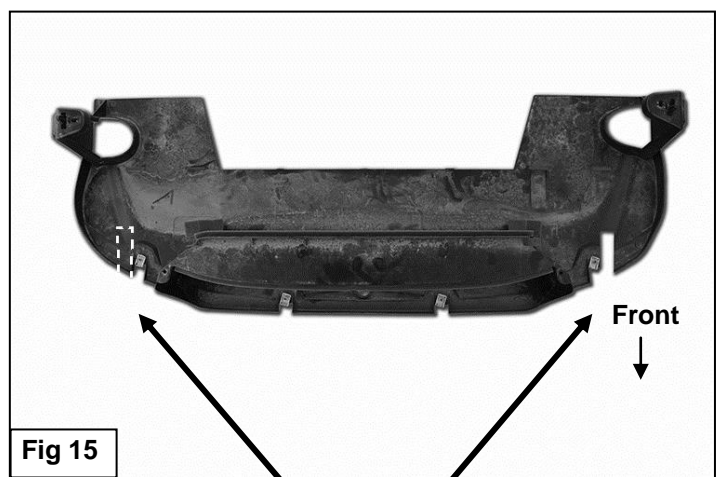
(2) 6mm Button Head Bolts  
(2) 6mm Lock Washers  
(2) 6mm Flat Washers

**(Fig 13) Attach Support Bracket to bottom of Grille Guard**

- Align and adjust the Grille Guard and fully tighten all hardware at this time.
- Hold the plastic splash guard up to the bottom of the Mounting Brackets, **(Figure 14)**. Trace the location of the Brackets onto the inside of the plastic cover. Use a sharp knife or hacksaw blade to cut out the sections from the cover, **(Figure 15)**. Reinstall the splash guard using the factory hardware.

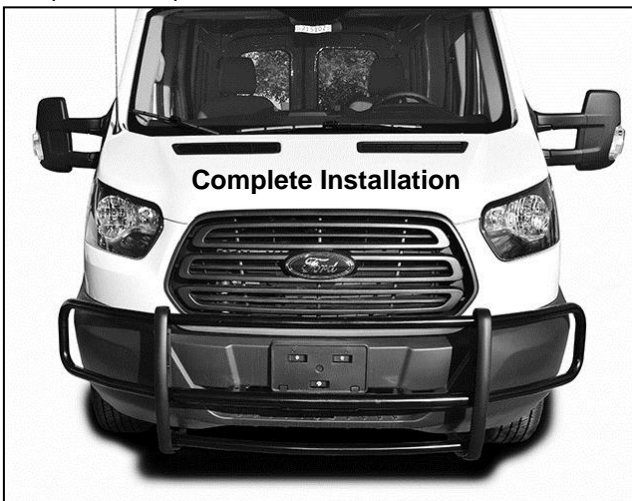


**Fig 14) Hold the splash guard up to the bottom of Frame Brackets. Trace location of Brackets onto back of the plastic cover**



**Fig 15**  
Trace location of Brackets onto back of the plastic cover (dashed line). Cut as required to clear brackets. Do not cut off mounting tabs and clips

- Reinstall the license plate bracket over the Support Bracket. On models with bracket held on with rivets, use the included (3) ST6x20mm Screws to reattach the license plate bracket.
- Do periodic inspections to the installation to make sure that all hardware is secure and tight.





**PRODUCT CARE**

- Periodically check the product to ensure all fasteners are tight and components are intact.
- Regular waxing is recommended to protect the finish of the product.
- **Use ONLY Non-Abrasive automotive wax.** Use of any soap, polish or wax that contains an abrasive is detrimental and can scratch the finish leading to corrosion.
- Aluminum polish may be used to polish small scratches and scuffs for **Stainless Steel finish.**
- Mild soap may be used to clean the product for both **Stainless Steel and Black finish.**

**FAQ's****1. Hardware's are not of correct size.**

*In GMC / Chevrolet truck model 2006 & up, customer needs to reuse the factory body bolts to install the bracket. If your vehicle is not GMC / Chevrolet 2006 & up, ensure that holes are not partially covered with any plastic grommet or rust? If it is, remove the plastic grommet & rust from the thread holes & re-try the installation.*

**2. Mounting Bracket are not getting Installed properly.**

*In some cases Illustration images shown in Installation manual may not be the exactly same as per actual vehicle images ,also if Driver / Passenger side mounting brackets are very identical in the design, suggest referring Parts Identification guide to avoid fitment issue.*

**3. Products are thumping / rattling after installation.**

*Ensure that all required mounting brackets / hardware's are installed & tighten correctly. Suggest using white lithium / regular grease between the metal to metal contact surfaces.*

**4. Side Bar is not aligning with vehicle / Step Pads are not aligning with vehicle doors.**

*Side bar may be interchanged or mounting brackets are not installed at the correct position in the vehicle. Refer Parts identification guide.*

**5. Missing / Excess Hardware.**

*Recheck hardware count as per the part list.*

**6. Product not installing properly.**

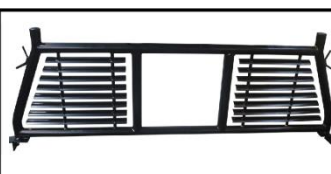
*Ensure make model year, cab length and bed size of your vehicle is listed in the application. All installation steps are followed correctly.*

Check out these other TrailFX Products!!

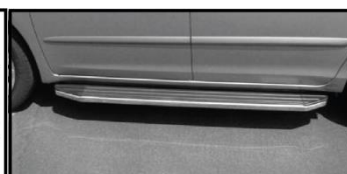
www.TrailFX.com



**SIDE BAR**



**HEADACHE RACKS**



**RUNNING BOARDS**



**ROCKER GUARDS**

Keystone Automotive Operations Inc. (KAO) warrants this product to be free of defects in material and workmanship at the time of purchase by the original retail consumer. KAO disclaims any other warranties, express or implied, including the warranty of fitness for a particular purpose or an intended use. If the product is found to be defective, KAO may replace or repair the product at our option, when the product is returned prepaid, with proof of purchase. Alteration to, improper installation, or misuse of this product voids the warranty. KAO's liability is limited to repair or replacement of products found to be defective, and specifically excludes liability for any incidental or consequential loss or damage.