

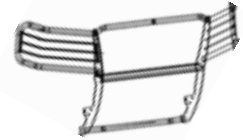

Grille Guard

Part No. 81370/1



Fits: **2007-2012 Toyota FJ Cruiser**



60-180 min

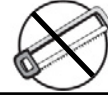

CUTTING NOT
REQUIRED



DRILLING NOT
REQUIRED



REMOVE CONTENTS FROM BOX. VERIFY ALL PARTS ARE PRESENT.



READ INSTRUCTIONS CAREFULLY BEFORE STARTING INSTALLATION.

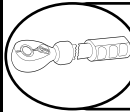

DO NOT OVER TORQUE. STANDARD OPERATING LOAD FOR TIGHTEN BODY MOUNT NUTS & BOLTS VARIES FROM **45 TO 65 FOOT POUND**.

PARTS LIST:

Qty	Part Description	Qty	Part Description
1	Grill Guard	4	10-1.5mm x 120mm x 30mm Hex Bolts
1	Driver/Left Lower Frame Bracket	8	10mm x 30mm OD x 2.5mm Flat Washers
1	Passenger/Right Lower Frame Bracket	4	10mm x 20mm x 2mm Flat Washers
1	Driver/Left Top Support Bracket	6	10mm Nylon Lock Nuts
1	Passenger/Right Top Support Bracket	4	8-1.25mm x 25mm Hex Bolts
1	Driver/Left Top Mounting Bracket	4	8mm ID x 16mm OD x 1.6mm Flat Washers
1	Passenger/Right Top Mounting Bracket	4	8mm Lock Washers
4	12-1.75mm x 30mm Hex Bolts	4	6-1.0mm x 25mm Hex Bolts
8	12mm x 37mm OD x 3mm Flat Washers	4	6mm x 12mm OD x 1.6mm Flat Washers
4	12mm Nylon Lock Nuts	4	6mm Lock Washers
2	10-1.5mm x 30mm Button Head Allen Bolts	1	6mm Allen Wrench

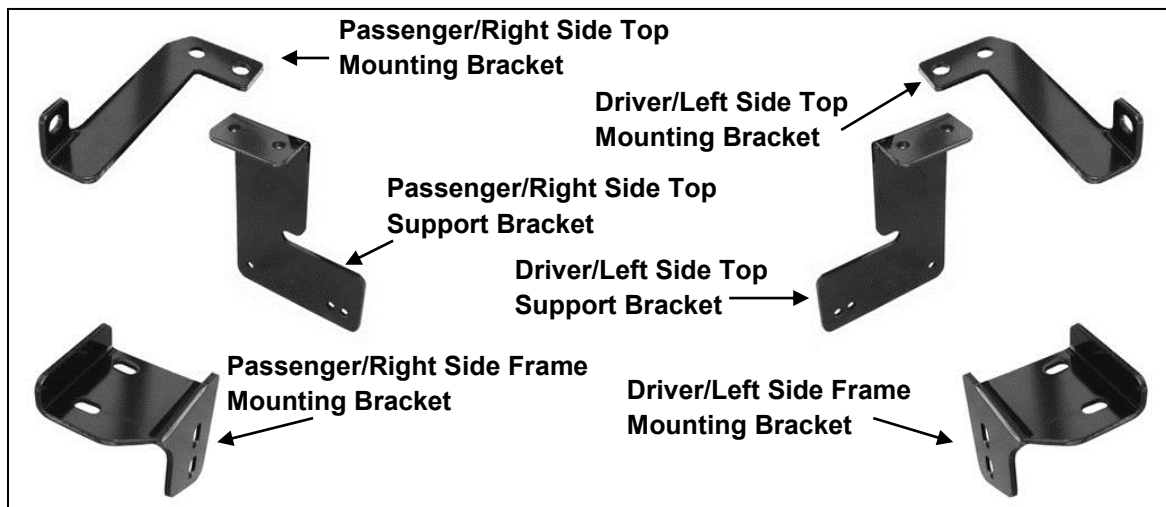

INSTALLATION PROCEDURE

1. Remove the factory skip plate if equipped. Starting behind the front bumper on the driver side, locate the section of rectangular frame channel attached to the back of the bumper, **(Figure 1)**. Insert (2) 10mm x 120mm Hex Bolts with (2) 10mm x 30mm Large Flat Washers into and down through the (2) vertical holes in the top of the bumper bracket, **(Figures 2 & 3)**. Select the driver side Frame Mounting Bracket. Line up the (2) slots in the Bracket with the (2) 10mm Hex Bolts. Secure the Bracket to the bottom of the bumper bracket with (2) 10mm x 30mm Large Flat Washers and (2) 10mm Nylon Lock Nuts, **(Figures 4A & 4B)**. Do not tighten hardware.
2. Repeat **Step 2** for passenger side Frame Bracket installation.
3. Next, remove the plastic grille and place it on a clean, stable work surface.

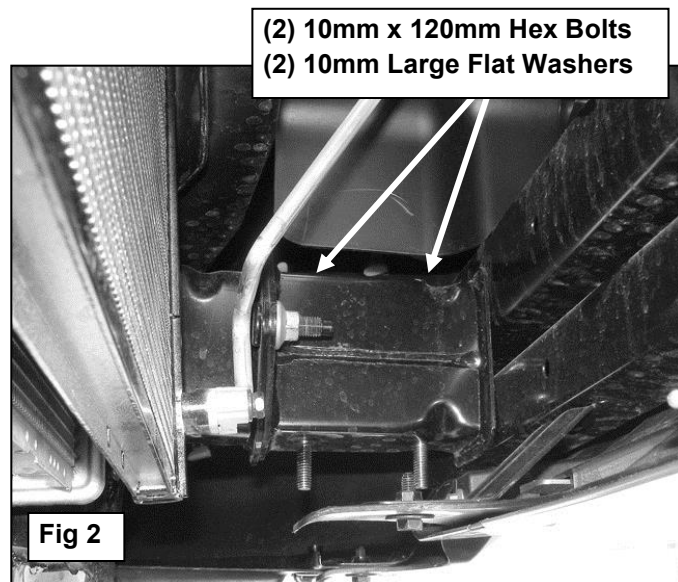
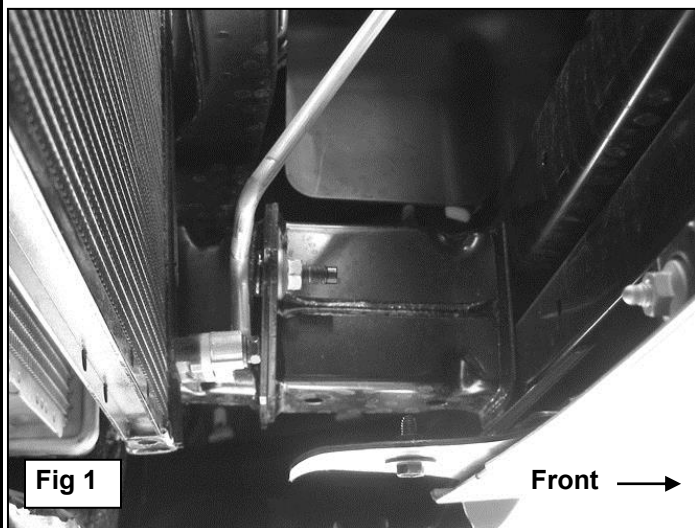

Driver Side Installation Pictured

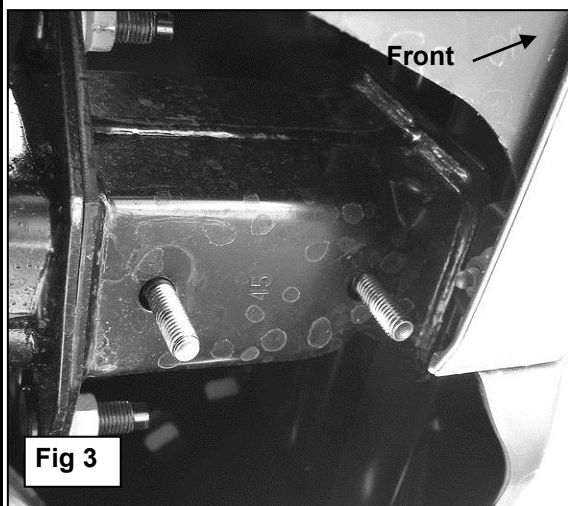

(2) 10mm x 120mm Hex Bolts
(2) 10mm Large Flat Washers

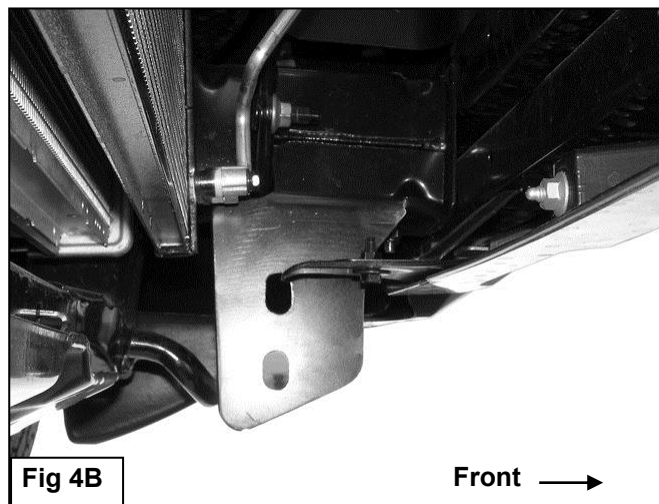
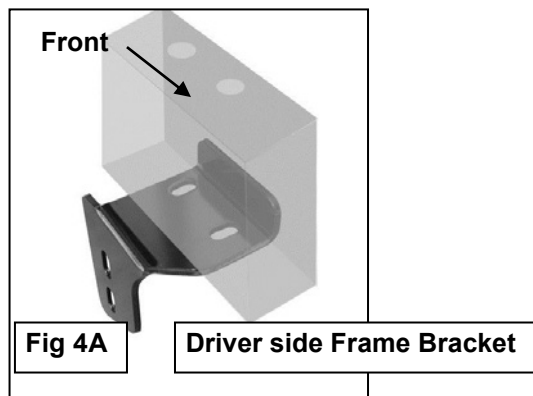

4. Select the driver side Top Support Bracket, **(Figure 5B)**. Line up the holes in the bottom of the Support Bracket with the threaded holes in the cross member. Bolt the Support Bracket to the cross member with (2) 6mm x 25mm Hex Bolts, (2) 6mm Lock Washers and (2) 6mm Flat Washers, **(Figures 5A – 5C)**. **NOTE:** Replace factory 6mm screws, (if equipped), from cross member with 6mm hardware. Fully tighten the 6mm hardware only at this time.
5. Repeat **Step 5** to install the passenger side Top Support Bracket.
6. Reinstall the grille using the factory hardware.

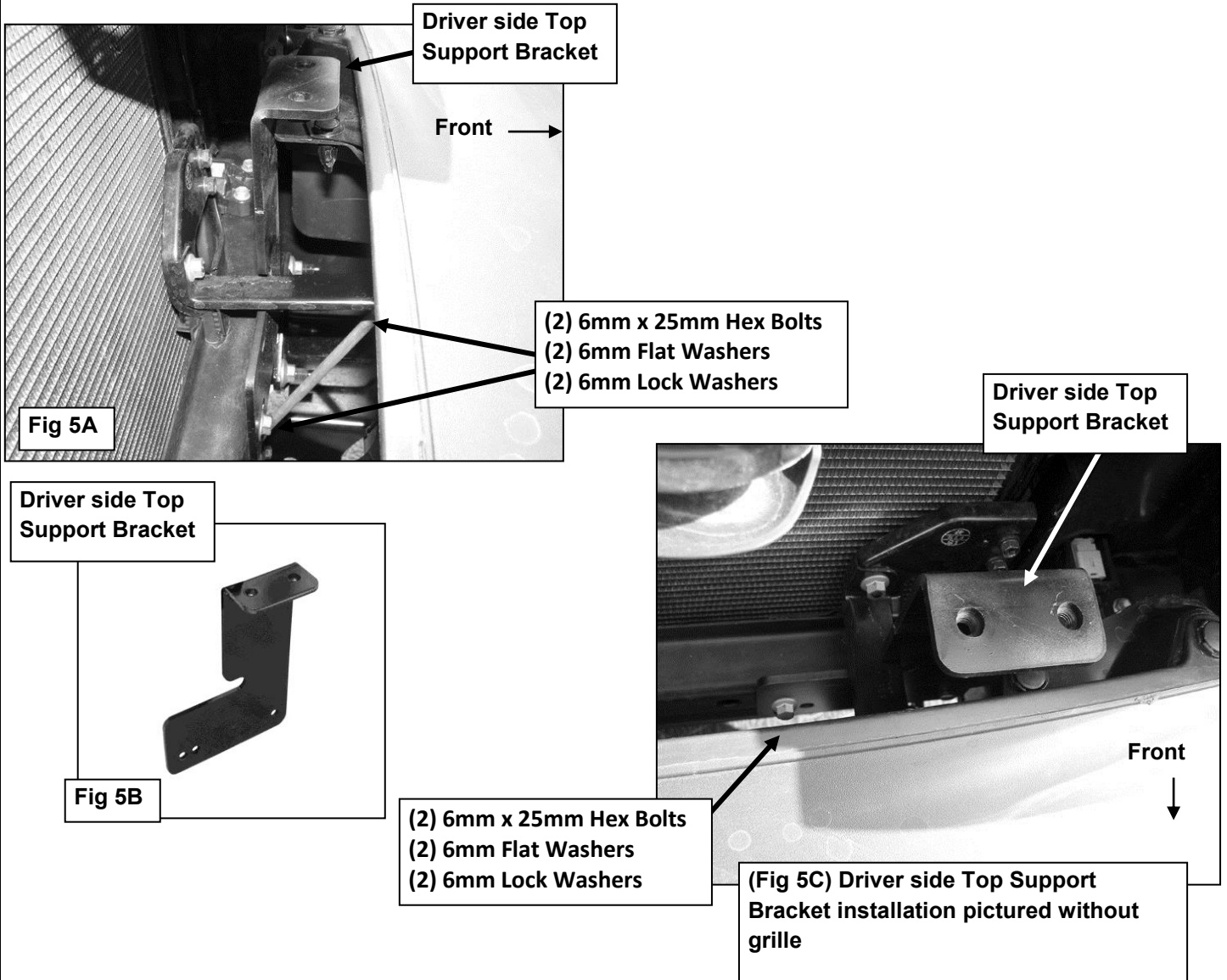

7. Select the driver side Top Bracket, **(Figure 6B)**. Insert the Bracket through the gap between the bottom of the grille and the top of the bumper, **(Figure 6A)**. Line up the (2) holes in the Top Bracket with the (2) threaded holes in the Support Bracket, **(Figure 7)**. Bolt the Top Bracket to the Support Bracket with the included (2) 8mm x 25mm Hex Bolts, (2) 8mm Lock Washers and (2) 8mm Flat Washers, **(Figure 8)**. Snug but do not fully tighten hardware.

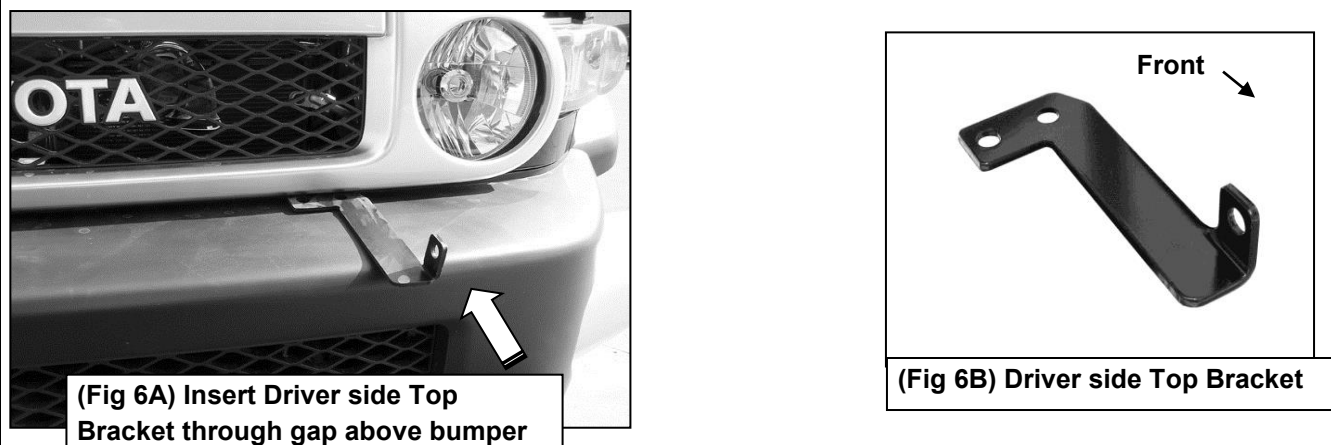

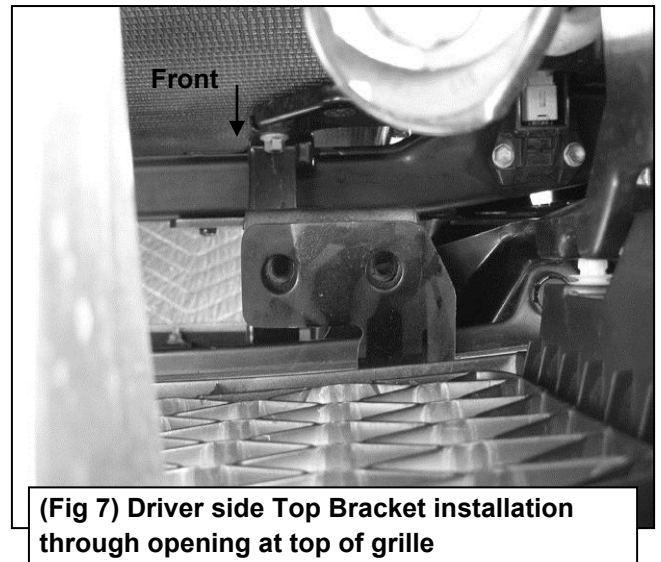
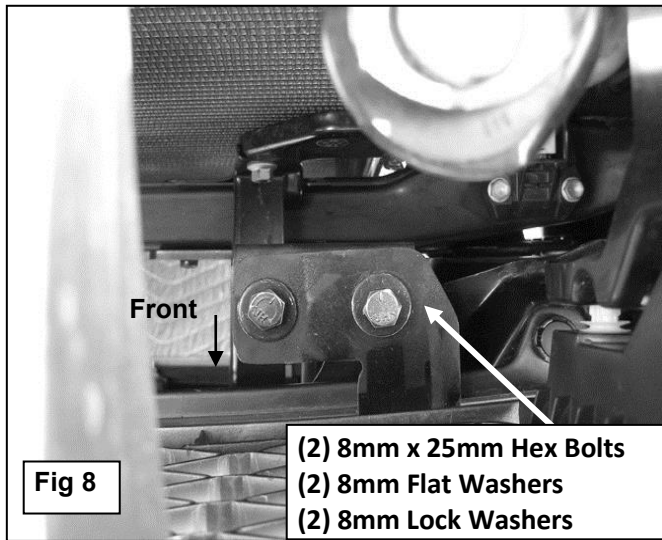

8. Repeat **Step 8** for passenger side Top Bracket installation.
9. With assistance, position the Grille Guard onto the outside of the Frame Mounting Brackets. Use the included (4) 12mm x 30mm Hex Bolts, (8) 12mm Flat Washers and (4) 12mm Nylon Lock Nuts to attach the Grille Guard to the Frame Brackets, **(Figure 9)**.
10. Line up the mounting hole in the driver side Top Bracket with the corresponding hole in the upright on the Grille Guard. Bolt the Top Bracket to the Grille Guard with the included (1) 10mm x 30mm Button Head Bolt, (2) 10mm x 20mm Small Flat Washers and 10mm Nylon Lock Nut. Do not tighten hardware at this time. Repeat this Step to bolt the passenger side Top Bracket to the Grille Guard.
11. Align the Grille Guard properly and tighten all Brackets mounting hardware including the Top Bracket to Support Bracket hardware.
12. Temporarily remove the Grill Guard. Reinstall the factory skid plate. Reinstall the Grille Guard and tighten all hardware, **(Figure 9)**.
13. Do periodic inspections to the installation to make sure that all hardware is secure and tight.

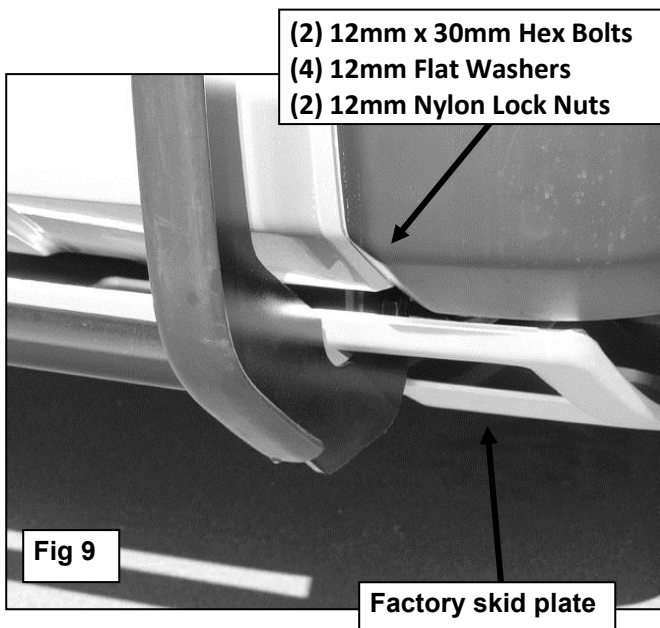

PRODUCT CARE

- Periodically check the product to ensure all fasteners are tight and components are intact.
- Regular waxing is recommended to protect the finish of the product.
- **Use ONLY Non-Abrasive automotive wax.** Use of any soap, polish or wax that contains an abrasive is detrimental and can scratch the finish leading to corrosion.
- Aluminum polish may be used to polish small scratches and scuffs for **Stainless Steel finish.**
- Mild soap may be used to clean the product for both **Stainless Steel and Black finish.**

FAQ's

1. Hardware's are not of correct size.

In GMC / Chevrolet truck model 2006 & up, customer needs to reuse the factory body bolts to install the bracket. If your vehicle is not GMC / Chevrolet 2006 & up, please ensure that holes are not partially covered with any plastic grommet or rust? If it is, please remove the plastic grommet & rust from the thread holes & re-try the installation.

2. Mounting Bracket are not getting Installed properly.

In some cases Illustration images shown in Installation manual may not be the exactly same as per actual vehicle images ,also if Driver / Passenger side mounting brackets are very identical in the design, suggest referring Parts Identification guide to avoid fitment issue.

3. Products are thumping / rattling after installation.

Please ensure that all required mounting brackets / hardware's are installed & tighten correctly. Suggest using white lithium / regular grease between the metal to metal contact surfaces.

4. Side Bar is not aligning with vehicle / Step Pads are not aligning with vehicle doors.

Side bar may be interchanged or mounting brackets are not installed at the correct position in the vehicle. Please refer Parts identification guide.

5. Missing / Excess Hardware.

Recheck hardware count as per the part list.

6. Product not installing properly.

Ensure make model year, cab length and bed size of your vehicle is listed in the application. All installation steps are followed correctly.