



Grille Guard

Part No. 81310/1



Fits: **2005-2012** Nissan Xterra
2005-Current Nissan Xterra



MAY NOT FIT ON PR - 4X.



60-180 min

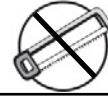

CUTTING NOT
REQUIRED



DRILLING NOT
REQUIRED



REMOVE CONTENTS FROM BOX. VERIFY ALL PARTS ARE PRESENT.



READ INSTRUCTIONS CAREFULLY BEFORE STARTING INSTALLATION.

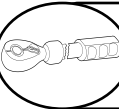

DO NOT OVER TORQUE. STANDARD OPERATING LOAD FOR TIGHTEN BODY MOUNT NUTS & BOLTS VARIES FROM 45 TO 65 FOOT POUND.

PARTS LIST:

Qty	Part Description	Qty	Part Description
1	Grille Guard	6	12-1.75mm x 35mm Hex Head Bolts
1	Driver/Left Mounting Bracket	16	12mm ID x 32mm OD x 3mm Flat Washers
1	Passenger/Right Mounting Bracket	10	12mm Lock Washers
1	Driver/Left Short Top Bracket (fits 05-08)	6	12mm Hex Nuts
1	Passenger/Right Short Top Bracket (fits 05-08)	4	6-1.00mm x 30mm Button Head Bolts
1	Driver/Left Tall Top Bracket (fits 09)	4	6mm ID x 18mm OD x 1.6mm Flat Washers
1	Passenger/Right Tall Top Bracket (fits 09)	4	6mm Lock Washers
4	12-1.25mm x 40mm Hex Head Bolts (fine thread)		

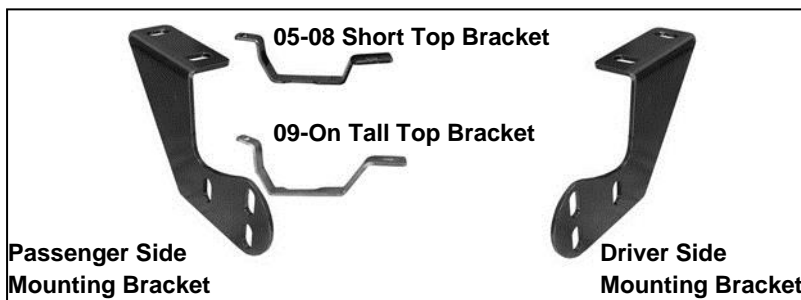

INSTALLATION PROCEDURE

1. From the under the front of the vehicle, remove the factory tow hook located on the passenger side. **NOTE:** You will not be re-installing the tow hook.
2. Locate the driver side Mounting Bracket and partially hang it from factory threaded holes in the frame rail using the included (2) 12-1.25 x 40mm Hex Head Bolts (fine thread), (2) 12mm Lock Washers and (2) 12mm Flat Washers (**Figure 1**). Repeat this step for the passenger side installation, (tow hook location). Snug but do not tighten hardware at this time.
3. Open the hood and remove the four plastic fasteners across the top of the grille shell, (**Figure 2**). **NOTE:** Use a small flat blade screwdriver to gently pry up the center pin to release the fastener. This will allow you to move the grille shell to insert the Top Bracket through the grille opening, (**Figure 3 & 4**).

Driver Side Installation Pictured

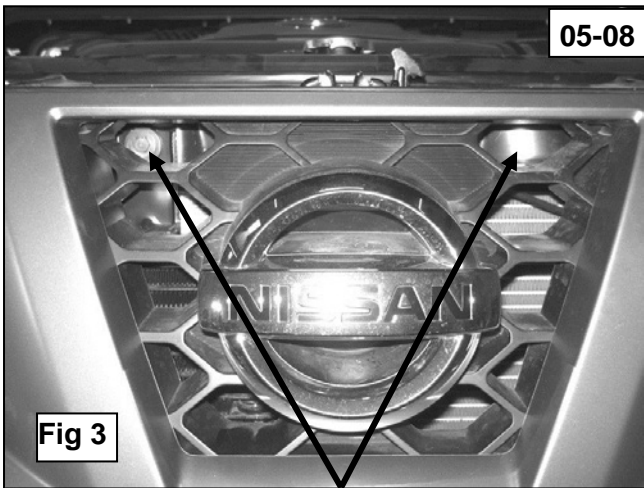
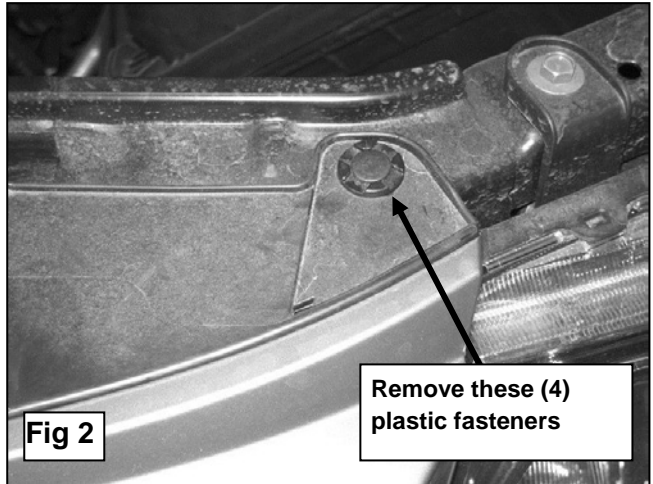
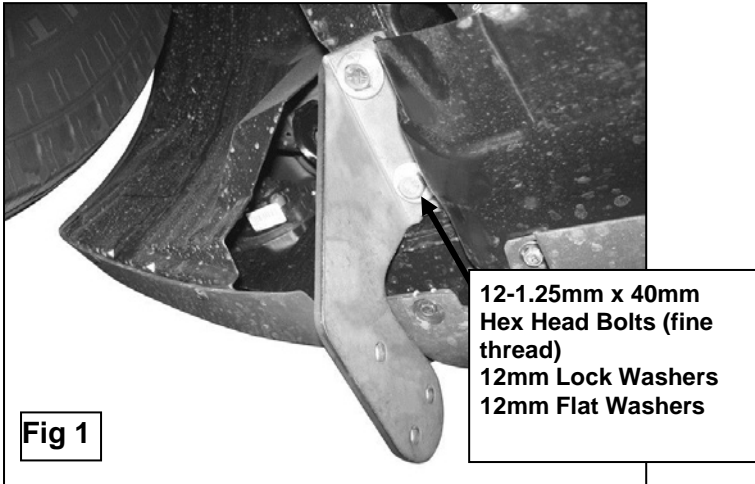

Insert Top Bracket
through here

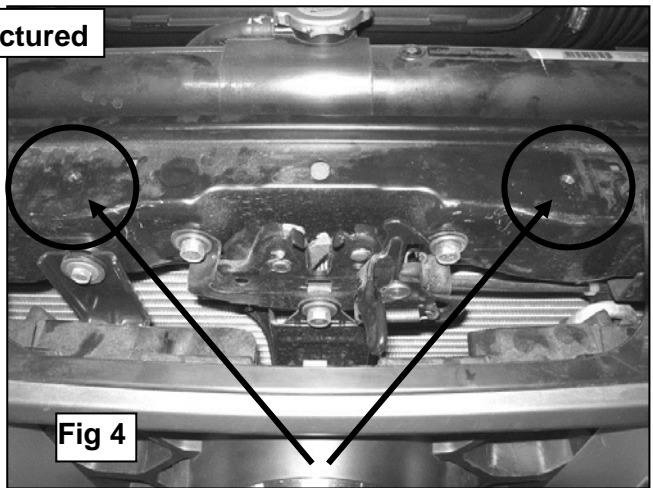

Top Bracket
Mounting Location

1. Determine the correct driver side Top Bracket for your application. The Top Brackets are notched to clear the plastic grille. See **Figure 5** for proper identification.
09-On Models: Use the Tall Top Bracket.
05-08 Models: Use the Short Top Bracket.
1. Gently pull on the grille shell as you insert the Top Bracket through upper corner of the grille, (**Figure 6**). Rotate the Top Bracket into position and line it up with the threaded hole in the radiator support. Attach it to vehicle using the included (1) 6mm x 30mm Button Head Bolt, (1) 6mm Lock Washer and (1) 6mm Flat Washer, (**Figure 7**). Do not tighten at this time.
2. With assistance, position the Grille Guard up to the inside of the Mounting Brackets. Use the included (6) 12mm x 35mm
3. Hex Head Bolts, (6) 12mm Lock Washers, (12) 12mm Flat Washers and (6) 12mm Hex Nuts to attach the Grille Guard to the Mounting Brackets, (**Figure 8**). Do not tighten at this time.
4. Push the Grille Guard into position and attach it to the Top Brackets using (2) 6mm x 30mm Button Head Bolts, (2) 6mm Lock Washers and (2) 6mm Flat Washers, (**Figure 9**).
5. Level and adjust the Grille Guard properly and tighten all hardware.
6. Re-install the upper section of the factory grille shell using the fasteners removed in Step 3.
7. Do periodic inspections to the installation to make sure that all hardware is secure and tight.

Driver Side Installation Pictured

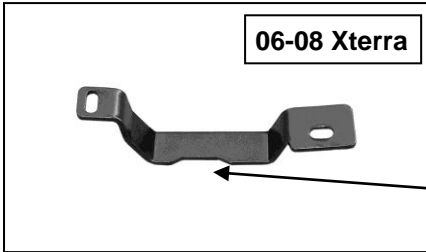

Driver/Left Side Short Top Bracket Pictured
05-08 Xterra
Note position of notch for grille clearance

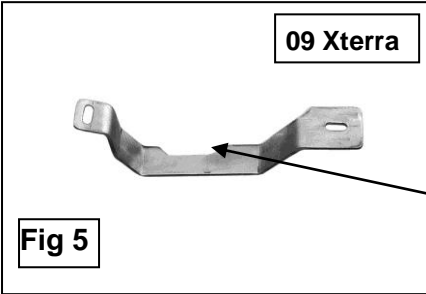

Note: 09 Top Brackets are slightly taller and longer with notch on opposite side from the 05-08 Brackets

Driver/Left Side Tall Top Bracket Pictured
09 Xterra
Note position of notch for grille clearance

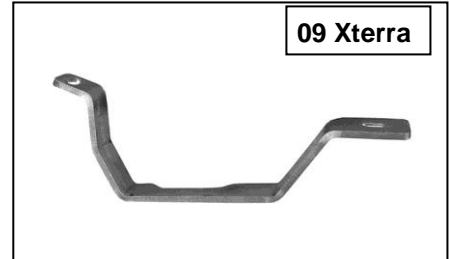
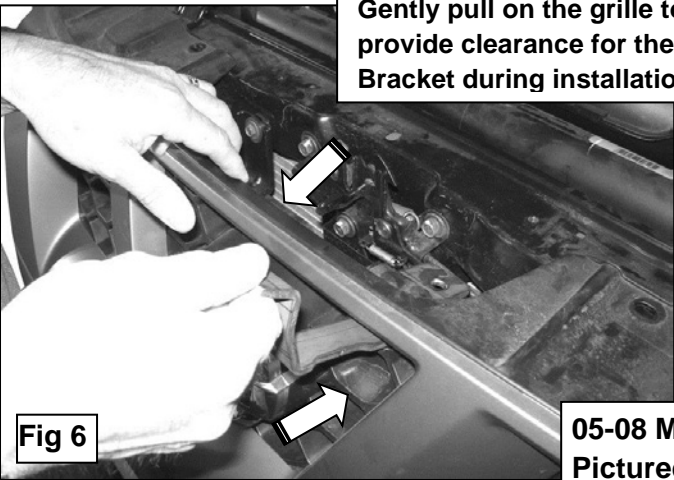

Fig 5



Gently pull on the grille to provide clearance for the Top Bracket during installation

Fig 6

05-08 Model Pictured

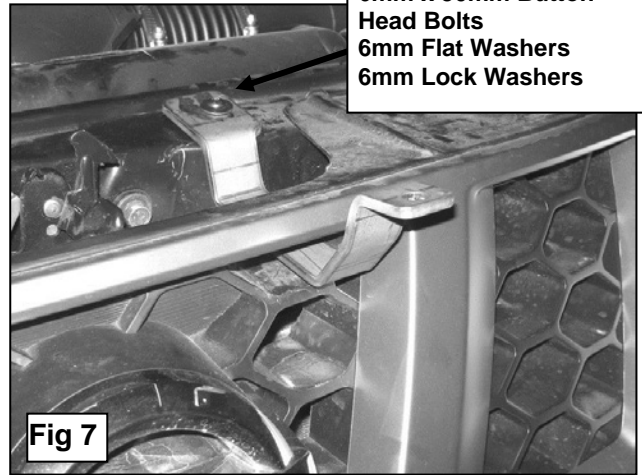

6mm x 30mm Button Head Bolts
6mm Flat Washers
6mm Lock Washers

Fig 7

05-08 Pictured

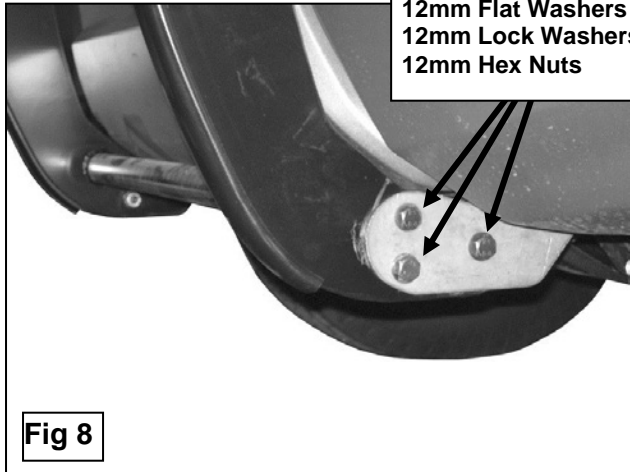

12mm x 35mm Hex Bolts
12mm Flat Washers
12mm Lock Washers
12mm Hex Nuts

Fig 8

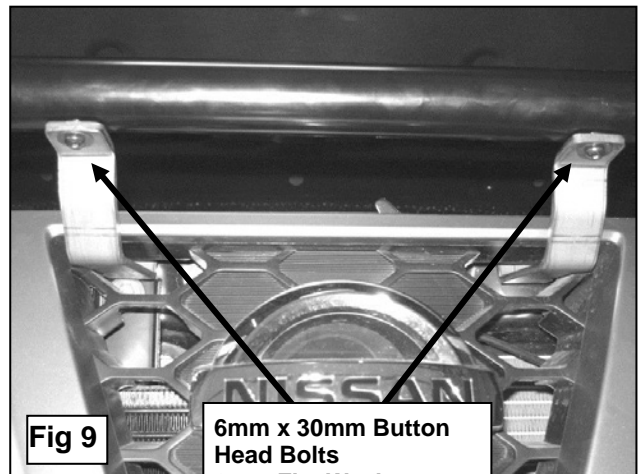

Fig 9

6mm x 30mm Button Head Bolts
6mm Flat Washers
6mm Lock washers



PRODUCT CARE

- Periodically check the product to ensure all fasteners are tight and components are intact.
- Regular waxing is recommended to protect the finish of the product.
- **Use ONLY Non-Abrasive automotive wax.** Use of any soap, polish or wax that contains an abrasive is detrimental and can scratch the finish leading to corrosion.
- Aluminum polish may be used to polish small scratches and scuffs for **Stainless Steel finish.**
- Mild soap may be used to clean the product for both **Stainless Steel and Black finish.**

FAQ's

1. Hardware's are not of correct size.

In GMC / Chevrolet truck model 2006 & up, customer needs to reuse the factory body bolts to install the bracket. If your vehicle is not GMC / Chevrolet 2006 & up, please ensure that holes are not partially covered with any plastic grommet or rust? If it is, please remove the plastic grommet & rust from the thread holes & re-try the installation.

2. Mounting Bracket are not getting Installed properly.

In some cases Illustration images shown in Installation manual may not be the exactly same as per actual vehicle images ,also if Driver / Passenger side mounting brackets are very identical in the design, suggest referring Parts Identification guide to avoid fitment issue.

3. Products are thumping / rattling after installation.

Please ensure that all required mounting brackets / hardware's are installed & tighten correctly. Suggest using white lithium / regular grease between the metal to metal contact surfaces.

4. Side Bar is not aligning with vehicle / Step Pads are not aligning with vehicle doors.

Side bar may be interchanged or mounting brackets are not installed at the correct position in the vehicle. Please refer Parts identification guide.

5. Missing / Excess Hardware.

Recheck hardware count as per the part list.

6. Product not installing properly.

Ensure make model year, cab length and bed size of your vehicle is listed in the application. All installation steps are followed correctly.