

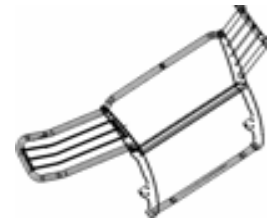

Grille Guard

Part No. 81140 / 81141



Fits: **2004-2008 Ford F150 (Excl. Heritage)**



FOR NON-TOW HOOK MODELS, THE PLASTIC LOWER BUMPER/AIR DAM WILL HAVE TO BE CUT FOR THE BRACKETS TO GO THROUGH OR REPLACED WITH THE FACTORY AIR DAM FOR TOW HOOKS



REMOVE CONTENTS FROM BOX. VERIFY ALL PARTS ARE PRESENT.



READ INSTRUCTIONS CAREFULLY BEFORE STARTING INSTALLATION.

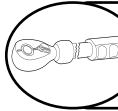

DO NOT OVER TORQUE. STANDARD OPERATING LOAD FOR TIGHTEN BODY MOUNT NUTS & BOLTS VARIES FROM 45 TO 65 FOOT POUND.



60-180 min

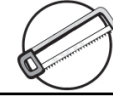

Cutting May be Required



Drilling Not Required



support@trailfx.com



1 866 638 4870



POLISHED STAINLESS STEEL – LIMITED LIFETIME
POWDER COATED BLACK – 3 YEARS

PARTS LIST:

Qty	Part Description	Qty	Part Description
1	Grille Guard	4	12mm x 44mm OD x 3mm Flat Washers
1	Driver/Left Frame Mounting Bracket	12	12mm x 32mm OD x 3mm Flat Washers
1	Passenger/Right Frame Mounting Bracket	4	12mm Lock Washers
1	Driver/Left 04-05 Top Support Bracket	6	12mm Nylon Lock Nuts
1	Passenger/Right 04-05 Top Support Bracket	2	10-1.5mm x 40mm Hex Bolts
1	Driver/Left Frame 06-08 Top Mounting Bracket	2	10-1.5mm x 30mm Button Head Bolts
1	Passenger/Right 06-08 Top Mounting Bracket	4	10mm x 30mm OD x 2.5mm Large Flat Washers
1	Driver/Left 06-08 Tall Top Support Bracket	2	10mm x 20mm OD x 2mm Small Flat Washers
1	Passenger/Right 06-08 Tall Top Support Bracket	2	10mm Lock Washers
2	12mm Double Nut Plates	2	10mm Nylon Lock Nuts
6	12-1.75mm x 40mm Hex Bolts	1	Wrench
4	12-1.75mm x 30mm Hex Bolts		

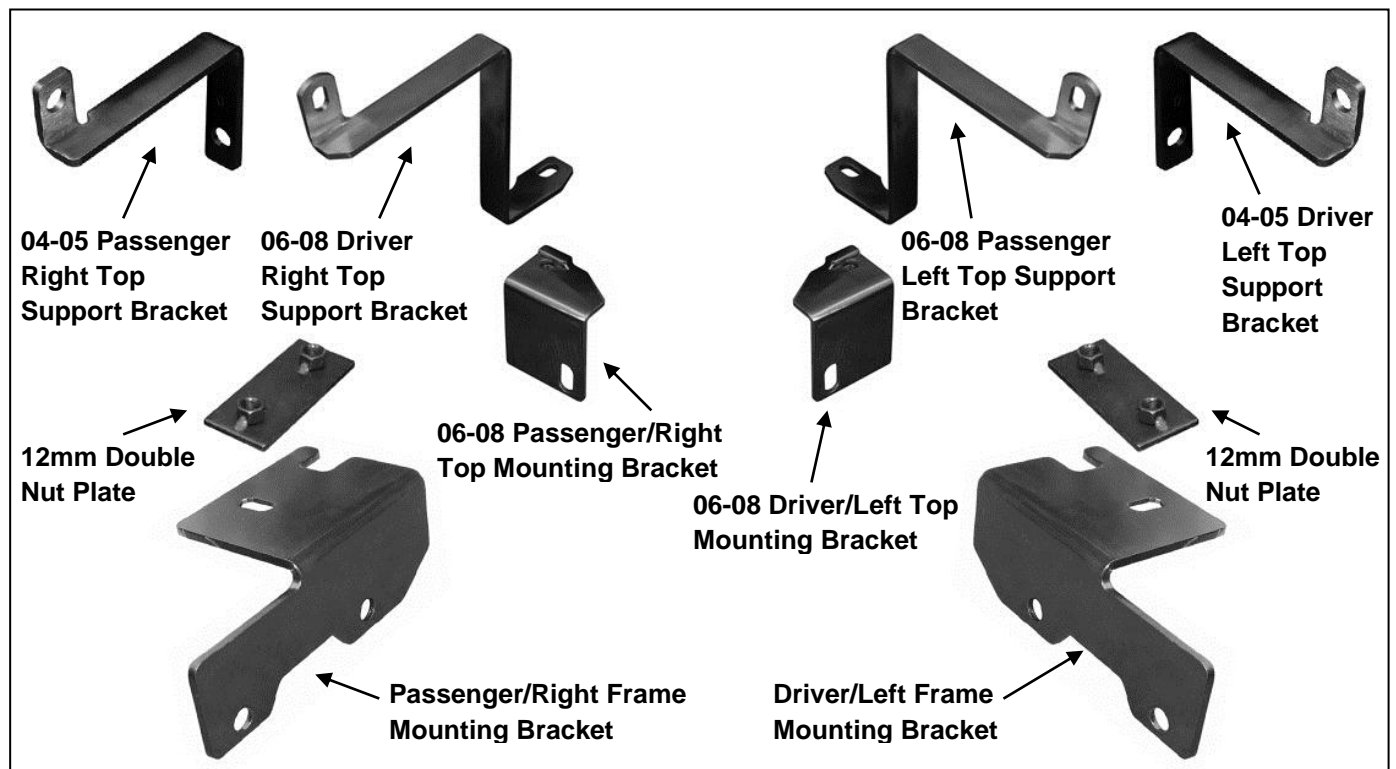

INSTALLATION PROCEDURE:

1. **THE GRILLE GUARD MAY INTERFERE WITH PARKING SENSORS, PROXIMITY SENSORS AND CRUISE CONTROL SENSORS.** Determine if the vehicle is equipped with or without factory tow hooks.

Vehicles with factory tow hooks:

- Start on the driver side and remove the forward hex bolt in the tow hook. Next, loosen the rear bolt but do not remove, (this will help hold the nut plate in the correct location inside the frame channel-see **Figure 2**). Slide the tow hook out from under the rear hex bolt. Keep the factory double nut plate in the frame and aligned with the holes.
- Position the Mounting Bracket up to the bottom of the frame and secure it with the factory tow hook bolts into the factory double nut plate, (**Figure 3**). **NOTE:** On some model years, the Grille Guard Brackets may not be compatible with the factory tow hooks. Reinstall the tow hook over the Bracket with the factory hex bolts if there is clearance.
- Repeat **Steps a – b** for the passenger side Frame Bracket installation.

Vehicles without Tow Hooks:

- Remove the lower plastic bumper cover/air dam, (**Figure 4**).

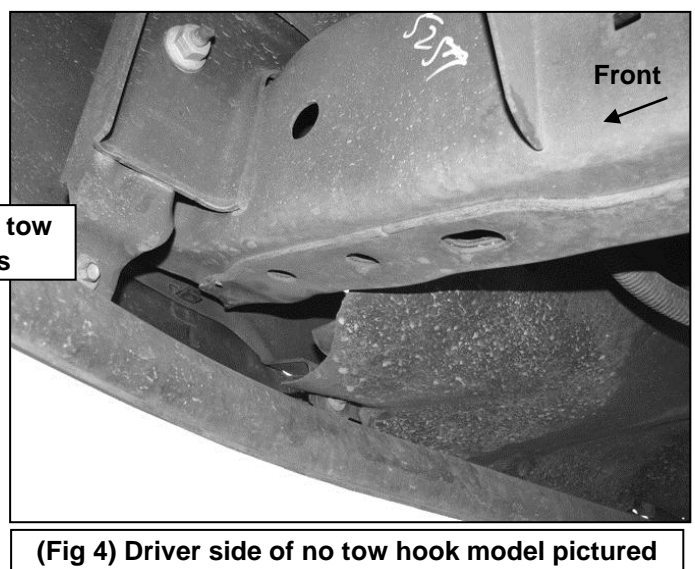
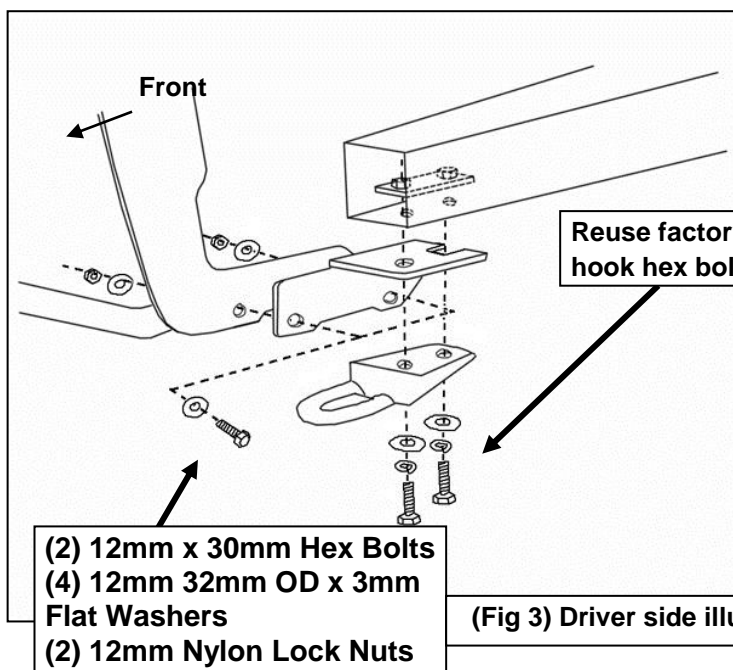
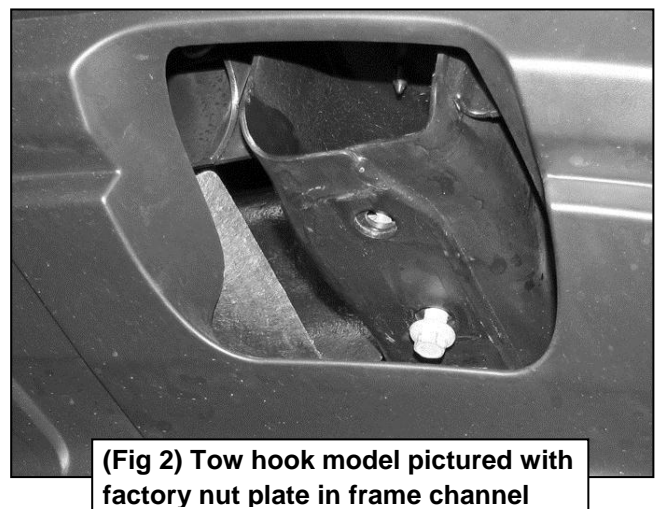
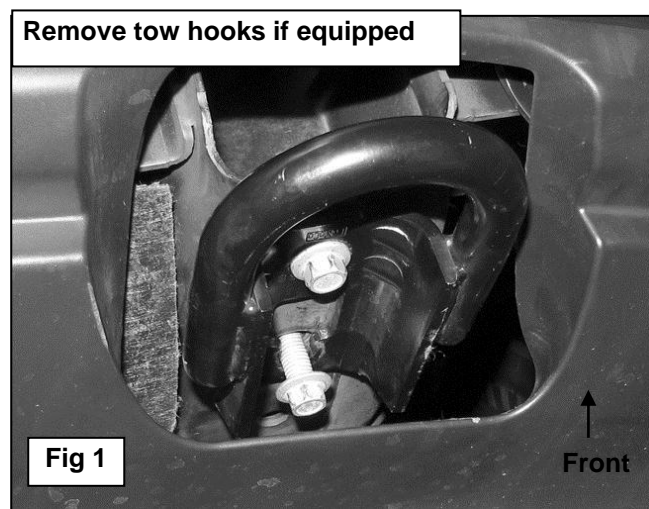

- Starting on the driver side of the vehicle, insert (1) 12mm Double Nut Plate through the opening in the open front end of the frame, (**Figures 5A & 5B**). Line up the threaded hex nuts on the Nut Plate with the (2) factory holes in the bottom of the frame channel. Hold the Nut Plate in position with (1) 12mm x 40mm Hex Bolt, (1) 12mm Lock Washer and (1) 12mm x 44mm Large Flat Washer partially threaded into the rearmost threaded hole in the Nut Plate, (**Figure 6**).

- c. Select the driver side Frame Mounting Bracket. Slide the slot in the Bracket under the 12mm Hex Bolt and Washers. Line up the remaining hole in the Bracket with the forward hole in the Nut Plate. Insert (1) 12mm x 40mm Hex Bolt, (1) 12mm Lock Washer and (1) 12mm x 44mm Large Flat Washer into the remaining hole in the Bracket, (Figure 6). Snug but do not fully tighten hardware at this time.
- d. Repeat **Steps b – c** to install the passenger side Frame Bracket.
- e. Hold the bumper cover up to the vehicle and mark the location of the (2) Brackets onto the inside of the cover, (Figures 7 & 8). Carefully cut (2) slots through the cover wide enough to clear the (2) Brackets, (Figure 9). **IMPORTANT:** Do not cut through the top or bottom edge of the cover. Reinstall the cover with the factory hardware.

Insert Nut Plate through opening in end of frame

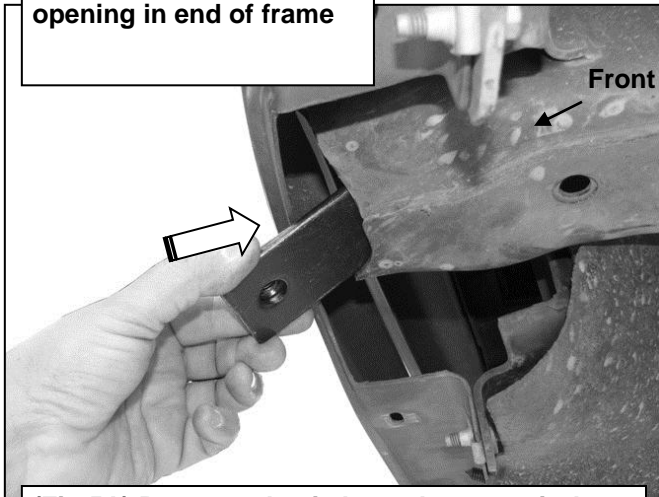

(Fig 5A) Remove plastic lower bumper air dam

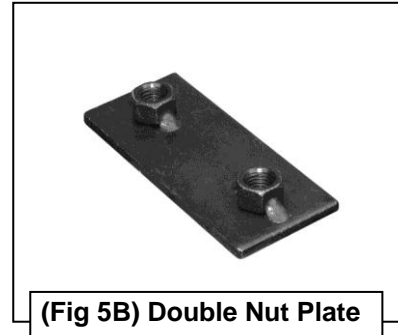

(Fig 5B) Double Nut Plate

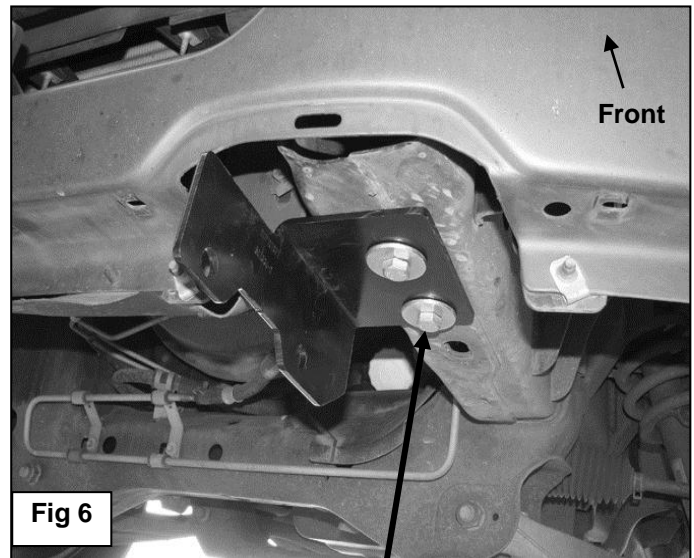

Fig 6

(2) 12mm x 40mm Hex Bolts
 (2) 12mm Lock Washers
 (2) 12mm 44mm OD x 4 mm Large Flat Washers

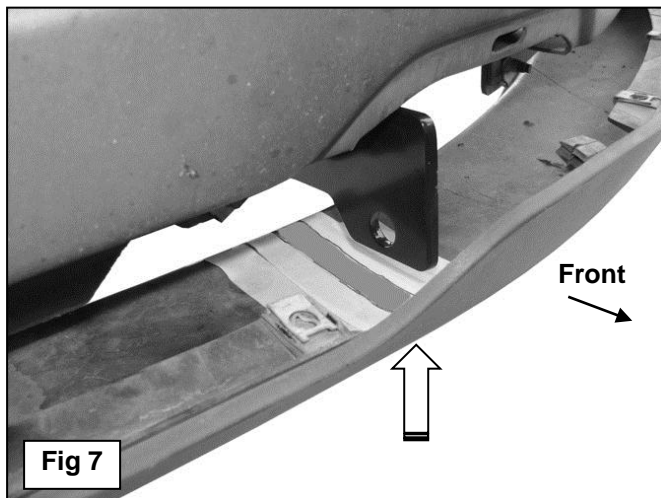

Fig 7

Important: Do not cut through the front or rear edge of the plastic bumper cover

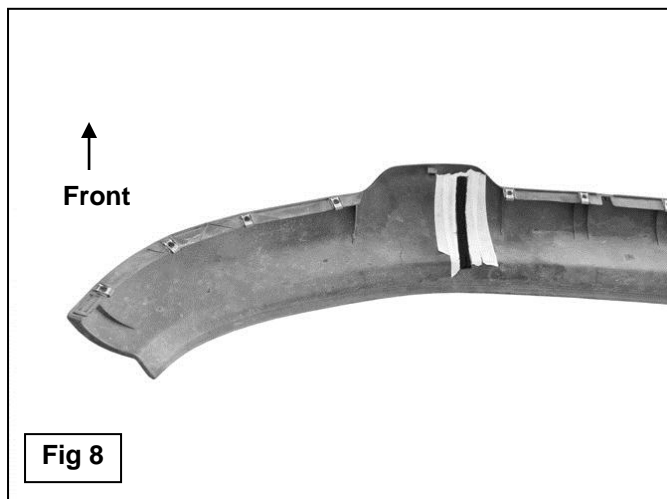

Fig 8

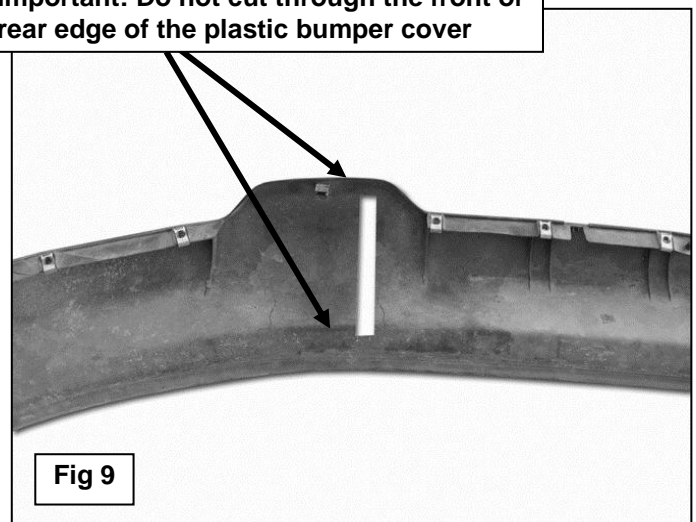
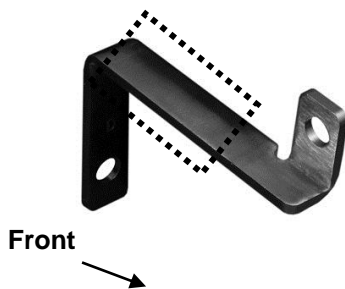

Fig 9

2. With help position the Grille Guard onto the inside of the Mounting Brackets. Use the included (4) 12mm x 30mm Hex Bolts, (8) 12mm x 32mm STD Flat Washers and (4) 12mm Nylon Lock Nuts to attach the Grille Guard to the Mounting Brackets, **(Figure 3)**. Do not tighten at this time.
3. Slowly open the hood and check for clearance. Select the appropriate Top Bracket installation:
 - 04 – 05 model years:**
 - a. Locate and remove the factory nut on the top of the bumper bracket. Select the driver side 04-05 Top Bracket, **(Figure 10)**.
 - b. Apply a section of the included Adhesive Backed Foam Tape to the Bracket in any location that may come in contact with the bumper or grille, **(Figure 10)**.
 - c. Attach the Bracket to the bumper bolt with the factory hex nut, **(Figure 11)**. Leave hardware loose at this time. Repeat **Steps a – b** for passenger side Support Bracket installation.

Apply Foam Tape to top and/or bottom of Support Bracket as necessary



(Fig 10) 04-05 Driver side Top Support Bracket

Factory bumper bracket hardware

10mm x 30mm Button Head Bolt
 10mm 20mm OD x 2mm Small Flat Washer (outside)
 10mm 30mm OD x 2.5mm Large Flat Washer (inside)
 10mm Nylon Lock Nut

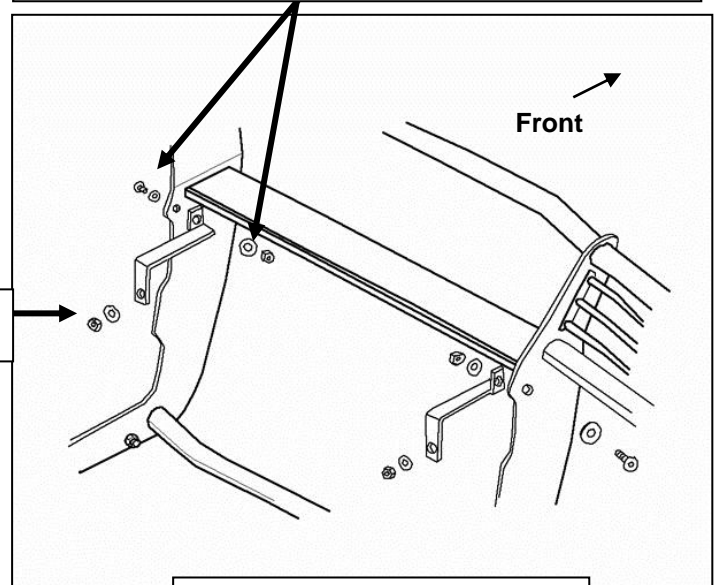

(Fig 11) 04-05 Top Support Bracket installation illustrated

06 – 08 model years:

- a. Locate the back of the factory bumper bracket, **(Figure 12)**. Select the small driver side 06-08 Top Mounting Bracket, **(Figure 13)**. Bolt the Bracket to the back of the large factory hole in the bumper bracket with (1) 12mm x 30mm Hex Bolt, (2) 12mm x 32mm Flat Washers and (1) 12mm Nylon Lock Nut, **(Figures 14A & 14B)**.
- b. Select the driver side 06-08 Top Support Bracket, **(Figure 15)**. Apply a section of the included Adhesive Backed Foam Tape to the Bracket in any location that may come in contact with the bumper or grille, **(Figure 16)**.
- c. Bolt the Support Bracket to the top of the Mounting Bracket with (1) 10mm x 40mm Hex Bolt, (1) 10mm Lock Washer and (1) 10mm Large Flat Washer, **(Figure 16)**.
- d. Tighten the Top Mounting Bracket to the bumper bracket hardware but leave the Top Support Bracket loose at this time. Repeat **Steps a – c** for passenger side installation.

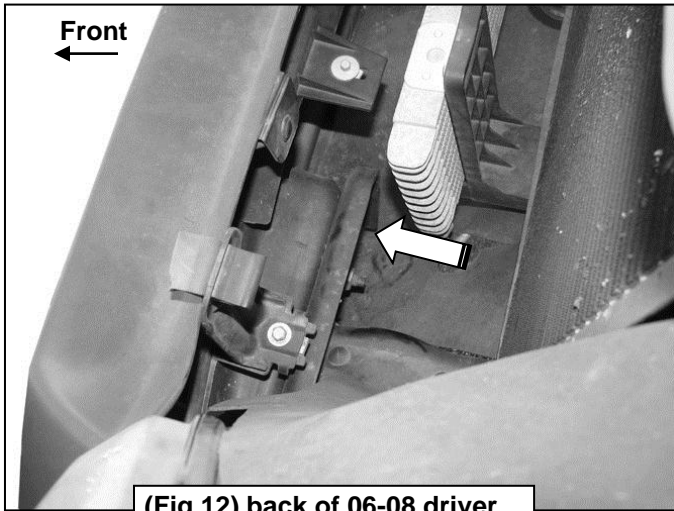

(Fig 12) back of 06-08 driver side bumper bracket pictured

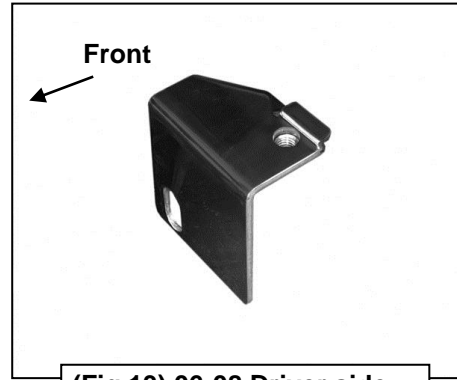

(Fig 13) 06-08 Driver side Top Mounting Bracket

12mm x 40 mm Hex Bolts
(2) 12mm x 32mm Flat Washer
12mm Nylon Lock Nut

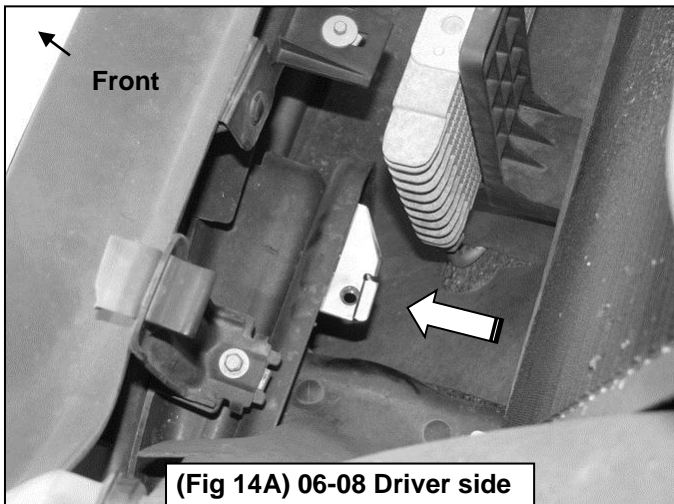

(Fig 14A) 06-08 Driver side Top Mounting Bracket

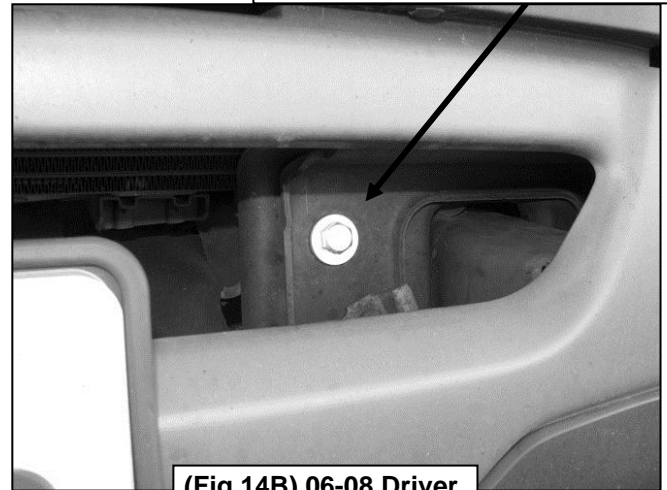

(Fig 14B) 06-08 Driver side bumper bracket

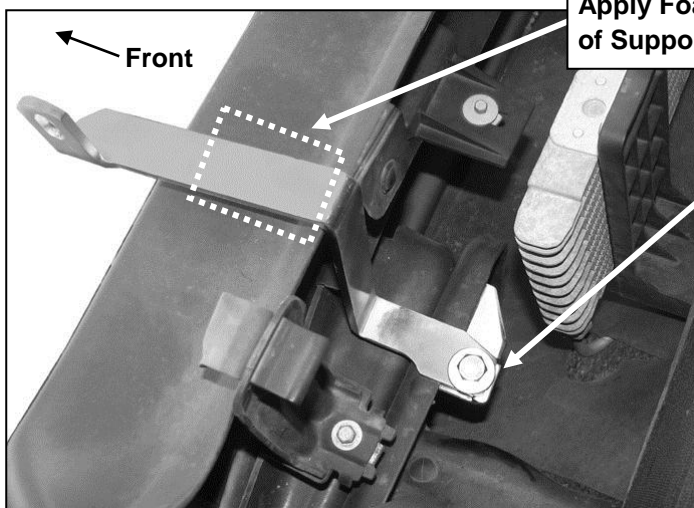

(Fig 16) 06-08 Driver side Top Support Bracket

10mm x 40mm Hex Bolt
10mm Lock Washer
10mm x 30mm x 2.5mm Large Flat Washer

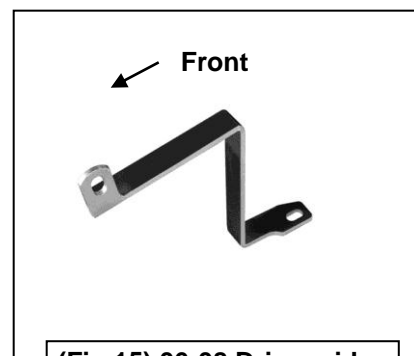

(Fig 15) 06-08 Driver side Top Support Bracket

4. Line up the tab on the driver side Top Bracket with the hole in the upright on the Grille Guard. Insert (1) 10mm x 30mm Button Head Bolt with (1) 10mm x 20mm Small Flat Washer through the upright and Top Bracket. Secure the Bracket to the Grille Guard with (1) 10mm x 30mm Large Flat Washer and (1) 10mm Nylon Lock Nut, **(Figures 11 & 17)**. Leave hardware loose at this time.

Apply Foam Tape to top and/or bottom of Support Bracket as necessary

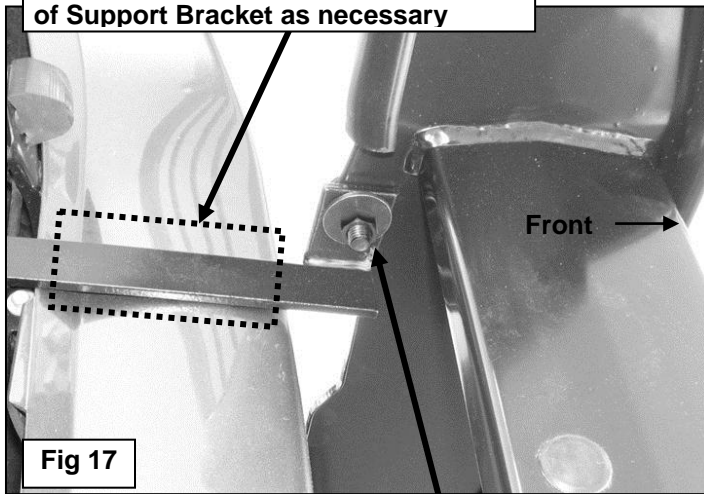

**10mm x 30mm Button Head Bolt
10mm x 20mm OD x 2mm Small Flat Washer (outside)
10mm x 30mm OD x 2.5mm Large Flat Washer (inside)
10mm Nylon Lock Nut**

5. Repeat **Step 4** for passenger side Top Support Bracket to Grille Guard installation.
6. Align and adjust the Grille Guard properly and tighten all hardware.
7. Do periodic inspections to the installation to make sure that all hardware is secure and tight.



PRODUCT CARE

- Periodically check the product to ensure all fasteners are tight and components are intact.
- Regular waxing is recommended to protect the finish of the product.
- **Use ONLY Non-Abrasive automotive wax.** Use of any soap, polish or wax that contains an abrasive is detrimental and can scratch the finish leading to corrosion.
- Aluminum polish may be used to polish small scratches and scuffs for **Stainless Steel finish.**
- Mild soap may be used to clean the product for both **Stainless Steel and Black finish.**

FAQ's**1. Hardware's are not of correct size.**

In GMC / Chevrolet truck model 2006 & up, customer needs to reuse the factory body bolts to install the bracket. If your vehicle is not GMC / Chevrolet 2006 & up, ensure that holes are not partially covered with any plastic grommet or rust? If it is, remove the plastic grommet & rust from the thread holes & re-try the installation.

2. Mounting Bracket are not getting Installed properly.

In some cases Illustration images shown in Installation manual may not be the exactly same as per actual vehicle images ,also if Driver / Passenger side mounting brackets are very identical in the design, suggest referring Parts Identification guide to avoid fitment issue.

3. Products are thumping / rattling after installation.

Ensure that all required mounting brackets / hardware's are installed & tighten correctly. Suggest using white lithium / regular grease between the metal to metal contact surfaces.

4. Side Bar is not aligning with vehicle / Step Pads are not aligning with vehicle doors.

Side bar may be interchanged or mounting brackets are not installed at the correct position in the vehicle. Refer Parts identification guide.

5. Missing / Excess Hardware.

Recheck hardware count as per the part list.

6. Product not installing properly.

Ensure make model year, cab length and bed size of your vehicle is listed in the application. All installation steps are followed correctly.

Check out these other TrailFX Products!!

www.FX-Products.com



BULL BAR



GRILLE GUARDS



BED RAILS



RUNNING BOARDS

Keystone Automotive Operations Inc. (KAO) warrants this product to be free of defects in material and workmanship at the time of purchase by the original retail consumer. KAO disclaims any other warranties, express or implied, including the warranty of fitness for a particular purpose or an intended use. If the product is found to be defective, KAO may replace or repair the product at our option, when the product is returned prepaid, with proof of purchase. Alteration to, improper installation, or misuse of this product voids the warranty. KAO's liability is limited to repair or replacement of products found to be defective, and specifically excludes liability for any incidental or consequential loss or damage.