



Marine Products



SEATING

ABOUT US

Todd products are **SALTWATER TOUGH!** All our seats and hardware meet the highest standards of the American Boat and Yacht Council (ABYC), so when you install a Todd seat, you will never worry about quality, durability or reliability. Every product in our line-up is designed to withstand the harsh saltwater environment and the demands of marine use. Each seat we mold uses SURPASS® Performance resins by NOVA® Chemicals, the strongest material ever used in the industry. Todd Marine Products has been servicing the marine industry for generations, providing the most innovative products at reasonable costs. Constant improvements in our products; service and shipping have kept Todd the number one source for boatbuilders and boat owners around the world. We're committed to delivering the best products efficiently and backing them with the best customer service in the business. Todd Products operates manufacturing facilities in Rhode Island, Tennessee and Florida.



40-1045

Miami Helm Seat

Designed for the sophisticated boater, this chair features a flip up bolster allowing it to act as either a supremely comfortable seat or as a leaning post. The dimensions allow for installation on center consoles and walk around cuddies 20' and up. The high gloss finish is impervious to the saltwater environment. Heavy duty marine grade tufted upholstery is double-stitched for years of reliable service.

Upholstered Seat : 40-1045

| Dimensions | D* | D** | W | H | |
|------------|-----|-----|---------------------|-----|-----------------------|
| ID: | 22" | 18" | 18" | 23" | * Flip Down Dimension |
| OD: | 22" | N/A | 22 ^{1/2} " | 26" | ** Flip Up Dimension |



Miami Double Wide Helm Seats

Upholstered Seat : 40-1045DW

| Dimensions | D* | D** | W | H | |
|------------|-----|-----|---------------------|-----|-----------------------|
| ID: | 22" | 18" | 18 ^{7/8} " | 23" | * Flip Down Dimension |
| OD: | 22" | 18" | 45" | 26" | ** Flip Up Dimension |



40-1045DW



SEATING

Hatteras Ladderback Seat

Our uniquely designed, one-piece molded ladderback is "patent pending." Here is a modern look you won't find anywhere else. Ultra-low maintenance, extra heavy duty components - ideal for saltwater use. Count on this seat for years of trouble-free service.

Seat & Cushions: 40-1050C - Seat Slider Package: 40-1050PK

Seat Slider ABYC Packages include: A seat, removable cushion set, manual swivel / slider and a 15" (38 cm) anodized aluminum pedestal.
All seats and cushion sets are white.

| Dimensions | D | W | H |
|------------|----------------------------------|----------------------------------|----------------------------------|
| ID: | 16" | 17 ¹ / ₂ " | 16 ³ / ₄ " |
| OD: | 22 ¹ / ₂ " | 23 ¹ / ₂ " | 20 ³ / ₄ " |



Patent Pending

40-1050C

Cape May Mahogany Back

Timeless ladderback helm chair with rich mahogany slats and integrated molded arm rests. Elegant and functional, this seat adds a touch of class wherever it is installed.

Seat & Cushions : 89-2032C

Seat Slider Package: 7200-01 (Mahogany) - Cushion Set : 3200

89-2032C



| Dimensions | D | W | H |
|------------|----------------------------------|-----|----------------------------------|
| ID: | 17 ¹ / ₂ " | 18" | 17 ¹ / ₂ " |
| OD: | 18 ¹ / ₂ " | 25" | 21 ¹ / ₂ " |

Cabo Supreme Helm Seat

The Cabo Supreme is offered with a maintenance free white plastic slatted back. Ideal for the modern sportfisherman. (Use Todd 6002A slider)

Seat Only : 97-2199W (White Slats)

Cushion Set (Bottom and Sides) : 3700 / Backrest: 3701

Seat Slider Pkg.: 97-2199WPK

Shown with optional cushions



97-2199W



| Dimensions | D | W | H |
|----------------|-----|-----|----------------------------------|
| ID no cush: | 17" | 19" | 20 ¹ / ₂ " |
| OD: | 21" | 27" | 23 ¹ / ₄ " |
| ID w/all cush: | 15" | 17" | 18" |

Gloucester Captain & Companion Seat

A true classic. Tufted removable cushions of the highest quality in its class accentuate this seat. The back is made from starboard and supported by heavy anodized aluminum brackets.

Seat & Cushions : 94-1500D

Seat Slider Package: 1500-01D / Cushion Set: 3800

Seat & Cushions : 94-1500DCMP (Companion No Arms)

Seat Slider Package: 1500-01DCMP

94-1500D



94-1500DCMP

| Dimensions | D | W | H |
|------------|----------------------------------|----------------------------------|----------------------------------|
| OD: | 21 ³ / ₄ " | 32" | 20 ³ / ₄ " |
| ID: | 16" | 24 ¹ / ₈ " | 16 ³ / ₄ " |

| Dimensions | D | W | H |
|------------|----------------------------------|-----|----------------------------------|
| OD: | 21 ³ / ₄ " | 18" | 20 ³ / ₄ " |
| ID: | 16" | 18" | 16 ³ / ₄ " |

without arms

All **todd** Seats & Hardware
ABYC
 Compliant



SEATING

Cape Cod Seat

America's # 1 Saltwater Seat. A favorite among discriminating boaters for years, this classic seat affords good looks and extreme comfort. Redesigned cushion updates this classic beauty.

Seat & Cushions : 85-1556C - Seat Slider Package: 7050-15

Cushion Set : 3150 (For Seats Made After 2007)

Cushion Set : 3100 (For Seats Prior to 2007)

| Dimensions | D | W | H |
|------------|---------------------|-----|---------------------|
| ID: | 17 ^{1/2} " | 18" | 17 ^{1/2} " |
| OD: | 18 ^{1/2} " | 25" | 21 ^{1/2} " |

85-1556C



Freeport Seat

The World's Best Selling Saltwater Boat Seat. A great looking chair that features lasting quality, it is designed for economy-minded boaters. Fishing or cruising, this seat is a solid pick.

Seat & Cushions : 971537-LC - Seat Slider Package: 7800

Seat Spider Package: 7800-15

Cushion Set : 3301

| Dimensions | D | W | H |
|------------|-----|---------------------|---------------------|
| ID: | 14" | 16" | 15 ^{1/2} " |
| OD: | 17" | 20 ^{1/2} " | 18 ^{1/2} " |

971537-LC



Chesapeake Seat

Impervious to harsh saltwater use, the Chesapeake promises many seasons of uncompromising service. Ample and attractive, this chair is everything a serious boater looks for.

Seat & Cushions : 85-1538C - Seat Slider Package: 7550

Cushion Set : 3550

| Dimensions | D | W | H |
|------------|---------------------|---------------------|---------------------|
| ID: | 17" | 17 ^{1/2} " | 16" |
| OD: | 17 ^{3/4} " | 21 ^{3/4} " | 18 ^{1/2} " |

85-1538C



All todd® Seats & Hardware

ABYC
Compliant



Jupiter Seat

An excellent choice to upgrade existing seats in many cases. The marine-grade vinyl covered foam cushions are thick, comfortable and removable.

**Seat & Cushions : 95-4500C - Seat Slider Package: 7450
Cushion Set : 3450**

| Dimensions | D | W | H |
|------------|----------------------------------|----------------------------------|----------------------------------|
| ID: | 16 ¹ / ₄ " | 16 ¹ / ₂ " | 17 ¹ / ₂ " |
| OD: | 20" | 20 ¹ / ₄ " | 17" |



95-4500C

Point Loma Seat

Here is another choice for the boater that needs side entrance access to their seat. Molded-in double handgrips, top quality removable cushions.

**Seat & Cushions : 10-0106C - Seat Slider Package: 100108FP
Cushion set : 106-CS**

| Dimensions | D | W | H |
|------------|----------------------------------|----------------------------------|-----|
| ID: | 17" | 16 ¹ / ₂ " | 14" |
| OD: | 21 ³ / ₄ " | 18 ¹ / ₄ " | 19" |



10-0106C

5 Star Seat

Todd's premier seat is luxurious and ample. Extra thick upholstery, swing away arms, individual lumbar support cushions and an integrated headrest prove this seat was designed with the most discriminating owner in mind. Modern yet classic, it is ideal for use as a helm seat. It is suggested that the Todd slider (6002A) be used with this seat.

Full-sized reinforced bottom mounting plate.

Model # : U9705BK (black)

Model # : U9705WH (white)

5 Star w/ Flip Up Bolster:

Model # : U9705BK-FB (black)

Model # : U9705WH-FB (white)



U9705BK-FB

U9705BK



U9705WH



Type 5 Upholstered Bucket Helm Seat

Spacious and attractive, these make a restful helm seat. Many customers have upgraded their vessels, taking advantage of the five inch thick high density foam cushions that provide unparalleled support.

Single

Model # : U85-1546

| Dimensions | D | W | H |
|------------|----------------------------------|----------------------------------|----------------------------------|
| ID: | 16 ¹ / ₂ " | 17 ¹ / ₂ " | 15" |
| OD: | 24" | 24" | 20 ¹ / ₂ " |

Double Wide

Model # : U89-2029

| Dimensions | D | W | H |
|------------|-----|----------------------------------|----------------------------------|
| ID: | 16" | 41" | 15" |
| OD: | 24" | 45 ¹ / ₂ " | 20 ¹ / ₂ " |



U85-1546

U89-2029

All **todd** Seats & Hardware
ABYC
Compliant



FOR THE AVID FISHERMAN



PS-1000

Pro Strike Fisherman Seat

This classic ladderback seat is paired with a rugged 316 S/S quad base and Todd's chrome four-way rod gimbal to make for a truly **"Saltwater Tough"** and highly versatile chair! Use as a fishing chair or as comfortable cockpit seating. Todd uses only the finest materials. Ergonomically correct, The Pro Strike Fishing Seat can be relied upon for comfortable seating for hours at a time and the quality construction assures you years of reliable use. **Includes 4 piece tufted cushion set.**

Model # : PS-1000

Cushion Set - Model #: 3800 4 Pieces Included

| Dimensions | D | W | H |
|------------|---------------------|---------------------|---------------------|
| ID: | 16" | 19 ^{1/2} " | 16 ^{3/4} " |
| OD: | 21 ^{3/4} " | 30" | 35 ^{3/4} " |

The Supreme Sportfishing Seat Package

The choice of superior anglers coast to coast, this seat offers all the amenities of a luxury fighting chair. This is the ideal seat for serious recreational fishing due to outstanding functionality and substantial strength.

Package includes: Molded chairs with polyethylene slatted back • Cushion Set Side-Striking Arm Hoops & Gimbals • Front Gimbal • Pair of Gimbal Adjustment Brackets (for short butted fishing rods) • 15" Fixed Height Pedestal • 360° swivel and fore and aft slider. **Suggestion: Pair with 6900 Flush Mount Pedestal base on pg. 16**



70-0105

Model # : 70-0105

Cushion Set - Model #: 3700 3 Piece Set Bottom & 2 Sides

| Dimensions | D | W | H |
|------------|---------------------|-----|---------------------|
| ID: | 16 ^{1/2} " | 18" | 20 ^{1/2} " |
| OD: | 22 ^{1/2} " | 27" | 24" |

Battle Station

Tournament anglers around the world agree that the Todd Battle Station is the top in its class. Perfect for dedicated small boat anglers, The Battle Station provides control and support to fight big fish while reducing fatigue and conserving angler energy. It rotates a full 360 degrees and has a locking mechanism for maximum flexibility. This is the safe, easy and efficient way to take big game standing up.

Package includes: Cushioned Rod Support for trolling • Heavy Duty Security Belt • 31" to 41^{1/2}" Adjustable Height • Anodized Aluminum Pedestal • Cast aluminum gimbal • 9" 6 Hole Base

Model # : 20-3030

| Dimensions | D | W | H |
|------------|---------------------|-----|-----|
| OD: | 16 ^{1/2} " | 31" | 41" |



20-3030

THE ORIGINAL



SWING BACK COOLERS

Deluxe Swingback Coolers

These stylish, durable coolers feature stainless steel swing-arms, plush, ribbed marine grade vinyl upholstery, rounded interior corners to prevent bait from getting trapped, hinged lids with a recessed, rubberized gaskets for a tight seal (important for keeping contents cold), drain fittings and polyethylene mounting plates. The Cooler/Livewell version has a double-wall, foamed insulated interior.

70 Quart

Large Deluxe Cooler/Livewell Seat : 1792-18U (Insulated)

Large Deluxe Dry Storage Seat : 1792-18NI (Non-Insulated)

| Dimensions | D | W | H |
|------------|--------------------|-----|--------------------|
| OD: | 17 ^{3/4"} | 38" | 20 ^{1/2"} |

1792-18U



1792-URH (shown)



Angler Series

1792-URH*

1792-NIRH*

1792-CRH top section only*

*Includes 4 rod holders

Swingback Seats

Our most popular swingback style seat, features double-wall, foam insulated interior with rounded corners to prevent bait from getting trapped, stainless steel or mahogany swing-arms that fit into a recessed pocket, heavily padded white marine grade vinyl bottom and back cushions and a drain fitting. The wide flange around the bottom of the unit makes installation easy.

50 Quart Overall Height: 32"

Swingback Seat with Stainless Steel Arms: 1758-18A (Insulated)

| Dimensions | D | W | H |
|------------|-----|--------------------|-----|
| OD: | 18" | 35 ^{1/2"} | 19" |

1758-18A



1758-18U



Swingback Seat with Mahogany Arms: 1758-18U (Insulated)

| Dimensions | D | W | H |
|------------|-----|--------------------|-----|
| OD: | 18" | 35 ^{1/2"} | 19" |

Replacement Cushion Set 1758-C

QUICK & EASY REPLACEMENT FOR OLD WORN OUT PEDESTAL SEATS

Replace Your Old Pedestal Seats !!



Before

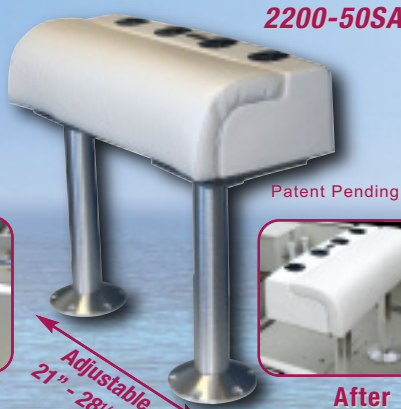

After

| Dimensions | D | W | H |
|------------|--------------------|--------------------|-----|
| OD: | 15 ^{3/4"} | 37 ^{1/2"} | 11" |

TODD LEANING POSTS feature rugged construction, tufted removable cushion, rod holders, anodized aluminum posts. Ideal for center console boats.

Universal Leaning Post (Pedestal Seat Replacement System)

This new system allows for easy replacement of old chairs with a new leaning post, without requiring the removal of existing pedestals. **Patent Pending**

- 3^{1/2"} "Magnum" Pedestals • Posts adjust from Port to Starboard
- Leave your old 2 7/8" pedestals in place • New posts adjust from 21" on center to 28.5" on center.

Model # : 2200-50SA

(Top only) Overall Ht: 32"

Optional Backrest #2201



LEANING POSTS

Optional
Backrest

2200-6013



Atlantis Professional Leaning Post

A complete system that includes a tufted flip forward upholstered seat and integrated spacious molded storage compartment under the seat cushion. Includes molded-in beverage holders, recessed removable cutting board for cutting limes, bait or rigging lures. Features aluminum frame, 15° rod holders, hinged flip-up footrest. Aluminum frame accommodates up to a 72 qt. Igloo cooler underneath. (Assembly required)

Model # : 2200-6013

| Dimensions | D | W | H |
|---------------------------------|-----|-----|-----|
| Top Only | 25" | 37" | 7" |
| Overall w/ Aluminum Frame | 25" | 37" | 48" |



Optional Backrest
2201



2200-35

Adjustable Height Leaning Post

This leaning post with adjustable height pedestals, can double as a seat with the optional backrest. Adjustable pedestals allow quick, easy, and secure changes in height.

Model # : 2200-35

| Dimensions | D | W | H |
|------------|----------------------------------|----------------------------------|-----|
| OD: | 15 ³ / ₄ " | 37 ¹ / ₂ " | 11" |

Height w/ Adjustable Pedestals: 16"-32"H Cutout: 24.5"W, 5"H

Distance between pedestals: 32" (81cm) on-center

Replacement Cushion for Standard & Adj. Leaning Post: 2200-C

Leaning Post Backrest

Fits on any existing Todd Leaning Post or any Leaning Post with 24" (61cm) on-center rod holders.

Model # : 2201

Single Portable Leaning Post

Easily attached and removed from an existing 2 7/8"OD chair pedestal tube so you can change from a seat to the Leaning Post or Back. Base plate under the Leaning Post provides the necessary adjustments fore and aft allows use on all boat sizes. Features 2 rod holders, an open storage compartment (12" wide x 4.5" high) and comfortably tufted cushions. Full height with pedestal is 32 1/4". Some assembly required.

Model # : 902200SP

Replacement Cushion: # : 2200-SC

902200SP



1005-D

Cupholder for Rod Holders

Accepts cans, mugs, and "huggies". Fits in standard 30° rod holders. Available in White only. **Patent Pending.**

Double Cup Holder : Model # : 1005-D

3¹/₂" D, 7" W; 3¹/₂" Cup Height: 6¹/₂" H



INFLATABLE ACCESSORIES & CONSOLES

Bench Seats

Features contoured ends that fit snugly between fully-inflated pontoons, a dry storage compartment, cutting board and a removable snap-on cushion.

Small Bench Seat: 94-3003 (For 8'-10' inflatable boats.)

| Dimensions | D | W | H |
|------------|-------------------|--------------------|-------------------|
| OD | 9 ^{1/4"} | 28" | 12" |
| Cutout | ---- | 12 ^{1/4"} | 5 ^{1/4"} |

Replacement Cushion: 9992-79

Large Bench Seat: 94-3004 (For 12'-14' inflatable boats.)

| Dimensions | D | W | H |
|------------|------|--------------------|-------------------|
| OD | 14" | 30 ^{5/8"} | 12" |
| Cutout | ---- | 12 ^{1/4"} | 5 ^{1/4"} |

Replacement Cushion: 9992-68



94-3003

Helmsman Console

Model # : 93-3003

Cutout: 12"W, 15 1/4"H

Instrument Panel: 19"W, 9"H

Helmsman Console only: 93-3003 Features two recessed cupholders and, a dry storage compartment.

| Dimensions | D | W | H |
|------------|-----|-----|-----|
| OD: | 18" | 25" | 32" |



93-3003

Steering Console

Includes grabrail. Windshield not available.

Model # : 95-3005

Cutout: 8 1/2"W, 11 1/2"H

Instrument Panel: 14"W, 3 5/8"H

| Dimensions | D | W | H |
|------------|--------------------|-----|--------------------|
| OD: | 16 ^{3/4"} | 14" | 32 ^{3/4"} |

*(Steering Wheel and Gauges
- Not Included -)*



95-3005

Bucket Potty Seat

Easy to carry and to store, the Bucket Potty attaches to a 3 or 5 gallon bucket (not included). The Bucket Potty features a unique press fit that holds the seat and plastic bag liner (not included) securely to the bucket. Ideal for boating, camping, construction or hunting.

White Bucket Potty: 8002-01W

| Dimensions | D | W | H |
|------------|--------------------|--------------------|-------------------|
| | 14 ^{3/4"} | 14 ^{3/4"} | 2 ^{1/2"} |

*"A MUST HAVE"
FOR EVERY
SURF CASTER*



8002-01W

BUCKET POTTY & BENCH ENDS

Todd Bench Ends

Constructed of durable, weather-resistant SURPASS® material. This unit assembles in minutes without the use of special tools and allow you to custom design the width of your bench (8' maximum). Simply add 2 x 4's to complete the bench. Available in a choice of four colors: Granite Gray, Granite Sand, Green and White. (you just supply the wood !!) **Product Dimensions: 25" Deep, 4" Wide, 31"High**

Bench End Product Number: **BE-1-__***

*To Specify color add GY (Granite Gray), or GN (Green) to the Product Number.



ELECTRONICS BOXES

Electronics Boxes

Todd's lightweight, easily mounted electronics boxes include stainless steel hinges, smoked plexiglass front panels, rubber gaskets, and chrome locks to protect valuables. A "Must Have" for every T-top.

Does Not Include Mounting Hardware.

Large Electronics Box: 88-1924 **Small Electronics Box: 95-1925**

Front Panel: 29"W, 8 3/4"H

Front Panel: 20 1/2"W, 6 1/4"H

| Dimensions | D | W | H |
|------------|---------|---------|---------|
| ID: | 15 3/4" | 31 1/2" | 11" |
| OD: | 16 1/2" | 32" | 11 1/4" |

| Dimensions | D | W | H |
|------------|-----|---------|--------|
| ID: | 13" | 23 1/4" | 9 3/4" |
| OD: | 14" | 24" | 10" |

88-1924



95-1925



Battery Boxes

Todd's battery boxes maintain their tough impact properties down to -40°. Featuring seamless, heavy wall construction, superior chemical resistance (eliminating concerns of electrolyte spills or contact with grease/oil) and full flow ventilation to ensure adequate cooling to enhance the longevity of the battery. Complies with USCG code of Federal Regulation #33 Sub-chapter 183.420, when properly installed.

4D Battery Box: 90-2138

| Dimensions | D | W | H |
|------------|---------|--------|---------|
| ID: | 20 1/2" | 9 1/2" | 11 1/2" |
| OD: | 24" | 13" | 13 1/2" |

8D Low Battery Box: 90-2169

| Dimensions | D | W | H |
|------------|---------|---------|--------|
| ID: | 21 1/2" | 11 1/2" | 9 1/2" |
| OD: | 25" | 15" | 12" |



90-2138

8D High Battery Box: 90-2170

| Dimensions | D | W | H |
|------------|---------|---------|---------|
| ID: | 21 1/2" | 11 1/2" | 11" |
| OD: | 24 1/2" | 15" | 14 1/2" |

8D High Double Battery Box: 91-2339

| Dimensions | D | W | H |
|------------|---------|---------|---------|
| ID: | 24 1/2" | 21" | 12 1/2" |
| OD: | 28" | 24 1/2" | 14 1/2" |



91-2339

Double Battery Box: 84-1480

| Dimensions | D | W | H |
|------------|---------|-----|-----|
| ID: | 16 1/2" | 11" | 8" |
| OD: | 17 1/2" | 13" | 11" |

Universal Battery Box: 1010187

| Dimensions | D | W | H |
|------------|---------|---------|----------|
| ID: | 14 1/2" | 7 3/4" | 10 3/16" |
| OD: | 17 1/4" | 10 1/2" | 12" |



Universal
1010187

Grp. 27/31 Battery Box: 01-1622

For use with group 27/31 Batteries

| Dimensions | D | W | H |
|------------|---------|--------|-----|
| ID: | 16" | 7 1/2" | 10" |
| OD: | 17 1/2" | 11" | 11" |

4D Battery Box: 1012000

| Dimensions | D | W | H |
|------------|---------|---------|---------|
| ID: | 20 1/4" | 9" | 12" |
| OD: | 23 5/8" | 12 1/2" | 13 3/4" |

TANKS - WATER, HOLDING

Water & Holding Tanks

Todd's one piece molded Water/Holding Tanks are tough and durable. Each tank fully complies with FDA regulation CFR 177.1520. Each tank satisfies all United States Coast Guard standards. SURPASS® material tanks will not emit waste odors or change the taste of fresh potable water. All openings are female NPT (National Pipe Threads) and are located in the same relative position on one end of the tank.

Supplied 2 - 1 1/2" & 2 - 3/4" Plugs make Water Tank or Holding Tanks. Complete instructions included

| Gallons | L | W | H | Holding Tank Product No. |
|---------|---------|---------|--------|--------------------------|
| 3 | 14" | 11" | 6 1/2" | 85-1859WH |
| 6 | 16" | 12" | 8" | 85-1531WH |
| 9 | 17" | 14" | 10" | 85-1667WH |
| 13* | 24" | 10" | 14" | 85-1626WH |
| 15* | 25" | 11" | 15" | 94-1627WH |
| 20 | 30" | 16" | 10" | 85-1666WH |
| 25 | 37" | 17 1/2" | 10" | 85-1532WH |
| 35* | 36" | 15 1/2" | 16" | 85-1525WH |
| 55* | 54 1/2" | 13" | 20" | 85-1533WH |

* Vertical

Water & Holding Tank Accessories

Fitting Relocation Kits enable a boater to plug up existing threaded fitting openings and to custom position the new fitting openings anywhere on the tank. Instructions included.

- 1) Water Tank Relocation Kit: 90-2218
 - 2) Holding Tank Relocation Kit: 90-2219
- } Both Include 4.5" Access Plate Hatch

Pipe-to-Hose Kits

Include all fittings needed to attach hoses to a water or holding tank. The opposite end of the fitting accepts the hose. All kits include Teflon Tape for easy installation and tight fit.

Water Tank Kits feature: (2)1/2" hose barb, (1)1 1/2" hose barb
Holding Tank Kits feature: (1)1/2" hose barb, (2)1 1/2" hose barb

- 3) Water Tank Straight Pipe-to-Hose Adapter Kit: 93-2222
- 4) Water Tank 90 Degree Pipe-to-Hose Adapter Kit: 93-2223
- 5) Holding Tank Straight Pipe-to-Hose Adapter Kit: 93-2220
- 6) Holding Tank 90 Degree Pipe-to-Hose Adapter Kit: 93-2221

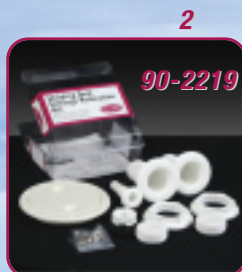
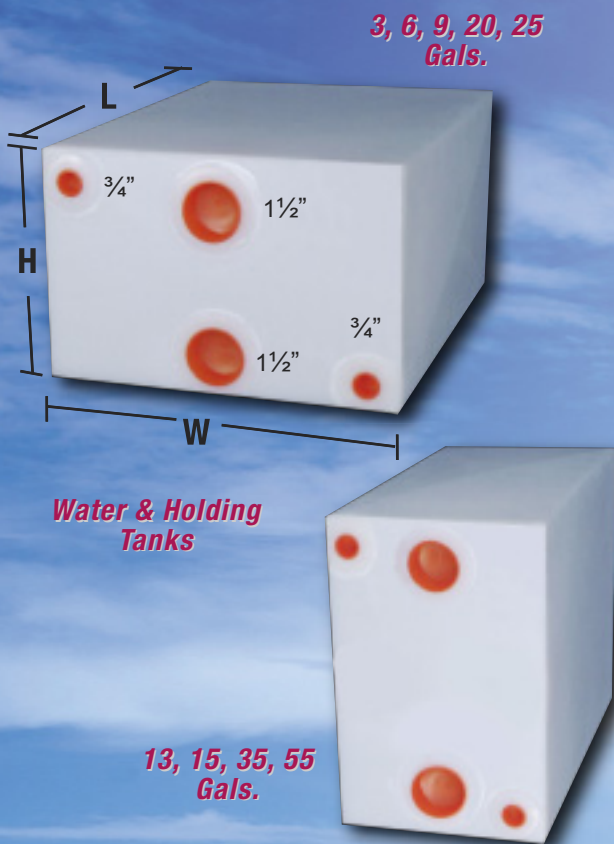

BOARDING STEPS

Boarding Steps

Todd's lightweight, durable Boarding Steps make access to your boat safe and convenient. A huge improvement over heavy and fragile fiberglass steps. You've seen them at every boat show because they are safe and reliable.

Single Step: 91-2333

| Dimensions | D | W | H |
|------------|--------------------|--------------------|----------------------|
| | 19 ^{1/4"} | 15 ^{1/2"} | 11 ^{15/16"} |



91-2333

Double Step: 91-2334

| Dimensions | D | W | H |
|------------|--------------------|--------------------|--------------------|
| | 21 ^{3/4"} | 20 ^{1/4"} | 17 ^{1/4"} |



91-2334

Double Step Handrail #91-2348

Triple Step: 91-2335

| Dimensions | D | W | H |
|------------|--------------------|--------------------|-----|
| | 31 ^{3/4"} | 20 ^{1/4"} | 26" |

Includes Handrail



91-2335

Quad Step: 93-2336

| Dimensions | D | W | H |
|------------|-----|-----|-----|
| | 36" | 20" | 32" |

Includes Handrail



93-2336

THE STRONGEST AND SAFEST STEPS.

THE PROFESSIONAL'S CHOICE

Add'l Handrails For Steps Made After 2011
Triple Step Handrail
11-2353

Quad Step Handrail
11-2354

Add'l Handrails For Steps Made Prior to 2011

Triple Step Handrail
91-2349

Quad Step Handrail
93-2352



GAS, DIESEL, WASTE CADDYS & GAS KART

"BEWARE OF IMITATORS"



GAS



P93-2400



WP-1



P93-2402



Gas and Diesel Caddys

The Gas and Diesel Caddys meet U.N. and D.O.T. specifications when used according to Todd's instructions for transporting fuel. All Caddys bear the UN Marking, "UN3H1W". U.S. Patent #5667113

Gas and Diesel Caddys hold 28 Gallons of fuel and meet D.O.T. requirements. Features include 10 Feet (305cm) of U.L. approved hose with static wire, molded hose brackets, U.L. approved, spring loaded nozzle, 3/4" U.L. approved ball valve, aluminum non sparking axle, pneumatic tires with nylon bearings, nylon wheel hubs, vented cap and a molded-in baffle for strength & durability. Optional pump kit is available to transfer fuel easily above the height of the caddy.

DIESEL



P93-2401

GAS - Part # : P93-2400

DIESEL - Part # : P93-2401

| Dimensions | D | W | H |
|------------|----------------------------------|----------------------------------|-----|
| | 22 ¹ / ₂ " | 27 ¹ / ₂ " | 41" |

Optional Pump

Industrial Pump : 2400-03

| PUMPS SPECS |
|--|
| Flow Capability. 10.3 Ounces per Revolution. |
| Operating Temp. (150 °F) to (-15 °F) |

Gas Kart

Gas Kart holds up to 15 gallons of fuel, handles and easily rolls to the dispensing site. The Gas Kart is a unique product that can be used for refueling lawn tractors, lawn mowers, ski mobiles, personal watercraft, boats, ATVs, snowblowers, generators, pumps, etc. Gas Kart meets UN and DOT specifications when used according to fuel transportation guidelines.

- 15 Gal Capacity • 6' long hose approved for fuel use • Brass shut-off valve
- Rolls easily on polypropylene wheels • Molded-in handle

| Dimensions | D | W | H |
|------------|-----|-----|-----|
| | 13" | 11" | 44" |

Waste Caddy

A portable waste removal system that holds 28 gallons of waste and can be rolled to a dump station. Features pneumatic non-sparking tires, vented cap, 10 Feet (305cm) of large diameter intake hose, 3" slide valve for evacuation, molded-in baffle for strength, molded hose holders and a hand operated manual pump. Intake hose fitting has proper threads to attach to standard deck fittings (1 1/2" or 1 1/4") and a quick disconnect fitting with a shut-off valve to control flow and eliminate spillage.

Part # : P93-2402

| Dimensions | D | W | H |
|------------|----------------------------------|----------------------------------|-----|
| | 22 ¹ / ₂ " | 27 ¹ / ₂ " | 41" |

Evacuation Kit: 93-2402P

Allows evacuation to a container higher than the Caddy.

~ 13 ~



IMPORTANT
ALL TODD CADDYS MEET
D.O.T. & U.N.
STANDARDS
PURCHASE A TODD CADDY
WITH CONFIDENCE

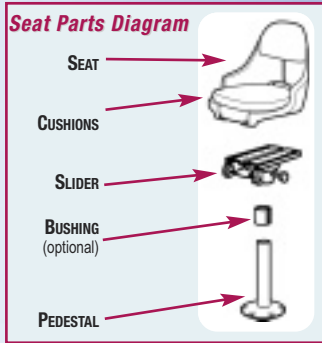

Pedestals

Made of polished, bright dipped, Marine Grade aluminum providing strong resistance to weathering and saltwater corrosion. Outside diameter of all pedestals is 2 7/8". Pedestal bases are 9" Diameter.

ABYC Fixed Height Pedestals: 53__A

Last 2 digits of the product number indicate the height of the pedestal in inches 12, 15, 18, 24, 30" Heights. **Welded for extra strength.**

Adjustable Pedestals: 5300

Features a manual knob adjustment from 14" to 20" (36-51cm) high. **Requires bushing part #: 9994-72 (not shown)**

Deluxe Adjustable Pedestals: 93-5300

The strongest adjustable pedestal available, it tightens with a 360° vice-grip style surface locking mechanism. Adjustment from 14"-20" without wobbling.



Sliders

Provides of positive locking fore and aft adjustment on nylon gibbs. Sliders are made of Marine Grade Aluminum. All components are designed to provide resistance to weathering and salt water corrosion. **"No Wobble Designs"**

ABYC Manual Super Slider: 5201A

Slider top plate is 7 1/4" W x 13" L (5" fore & aft)
Bolt pattern 12" x 5" W

ABYC Semi Automatic Slider: 6002A

Can be actuated from the starboard or port side.
Slider top plate is 9 1/2" W x 13 1/4" L
Bolt pattern 12" x 5" W & 10 3/8" x 8 3/4"

6002 Semi-Auto Slider (6 5/8" fore & aft) (not shown)

Slider top plate is 9 1/2" W x 13 1/4" L
Bolt pattern 12" x 5" W & 10 3/8" x 8 3/4"



Spider

Features 360° rotation with positive lock and friction knob. A 3" deep nylon bushing protects the pedestal from abrasion and scoring.

Anodized Aluminum Spider: 5203A

Used with 5202-P Mounting Plate.
Bolt pattern 5" x 5" W

Footrests and Collar

Footrest: 5205

Features aluminum casting, locking adjustment knob and nylon insert to prevent scratching of pedestal posts. Cannot be used with Adjustable Pedestals.

Dimensions: 13"W x 10 1/2"L - *Includes footrest collar*

Footrest Collar: 5205-1

Can be used to maintain a desired footrest height but allows the footrest to be swung out of the way. A nylon insert protects the post from scratches.



5205

Collar Included

5205-1

Bushings

Prevents abrasion between pedestals and mounting hardware. Slides over the top of a 2 7/8" OD pedestal.

Bushing: White: 9994-72



9994-72



Mounting Plates

Used to attach a spider to a chair. Pre-drilled, counter-sunk holes fit most hardware and seats.

Polyethylene Mounting Plate: 5202-P

White Only; **Dimensions:** 7 1/4"W x 13 1/8"L x 5/8"D



5202-P

Seat Stands

Cockpit Quad Base Stand: 20-1021-SS

Super stable, 316 stainless steel quad base with a 21" footprint.

The cockpit Quad Base is the simplest, cleanest design on the market and, because it's a Todd it is "Saltwater Tough."

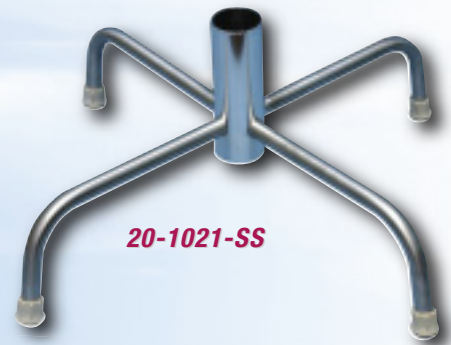

20-1021-SS

Seating Hardware Accessories

Center Gimbal: 5204

High polished chrome plated brass, fits most Todd chairs.

Mounting Ring: 6012

An aluminum mounting ring is used when there is no access below deck for through bolting a pedestal. The ring features six 3/8" holes for deck mounting and six 1/4-20" threaded holes for hardware installation.

It can also be a back-up for pedestal installation.

Dimensions: 9" (23cm) OD, 4 1/2" (12cm) ID



5204



6012

TABLE TOPS & PEDESTALS

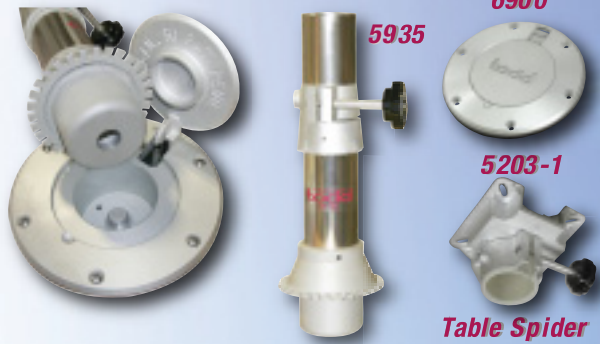

Todd's patented Flush Mount Base (#6900) requires either the Todd Adjustable Pedestal (#5935) OR the Todd 15" Fixed Height Pedestal (#5915). Also available for use with this unique system is the Todd 29" Fixed Height Table Pedestal (#6900-29). These Pedestals will accept: Table Spider (#5203-1), Seat Spider (#5203A), or Seat Sliders (#5201A, 6002A)

Pedestal / Table Post System

The patented Todd® Flush Mount Base system is the most versatile and easy to use pedestal base system ever designed for marine use. The system allows boaters to install a wide variety of fishing seats, rocket launchers, battle stations, table tops, etc. throughout their vessel. When desired, the seat or table may be quickly removed and stowed.

- Flush Mount Base (Diameter: 9 3/8") : 6900**
- 15" Pedestal : 5915 (not shown) Fixed Height**
- Adjustable Pedestal : 5935 Adjusts from 14 to 20 inches**
- 29" Fixed Height Table Post : 6900-29 (not shown)**
- Table Spider : 5203-1 - Allows for rotation of any table top.**

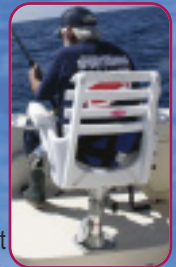

Posi-Lock Table Post System

All parts made of high grade, anodized aluminum. Bushing at bottom of post is threaded and screws into a threaded locking mechanism in the floor plate for a tighter, wobble-free fit. Post has tapered plastic end caps to eliminate corrosion. Floor plate can be recessed for flush mounting. **Patented.**

- Posi-Lock Square Floor Plate: 6005-1AS 6" x 6" x 3.5"**
- Round Table Plate: 6005-2S**
- Posi-Lock Table Post: 6005-__A Available 26" - 30"**
- Floor Plate Plug: 6005-P (Not shown)**

Push-Pull Table Post System

All parts made of high grade anodized aluminum. Push / pull systems are machined to extremely close tolerances to assure a tight fit between the floor plate and post. The post has plastic end caps to eliminate corrosion between the post and plates.

- Flush Mount Push-Pull Table Post System**
- Standard Push-Pull Table Post System**
- Square Flush Mount Floor Plate: 6005-1S**
- Round Table Plate: 6005-2S (Diameter: 7 1/2")**
- 26" Table Post: 6005-26**

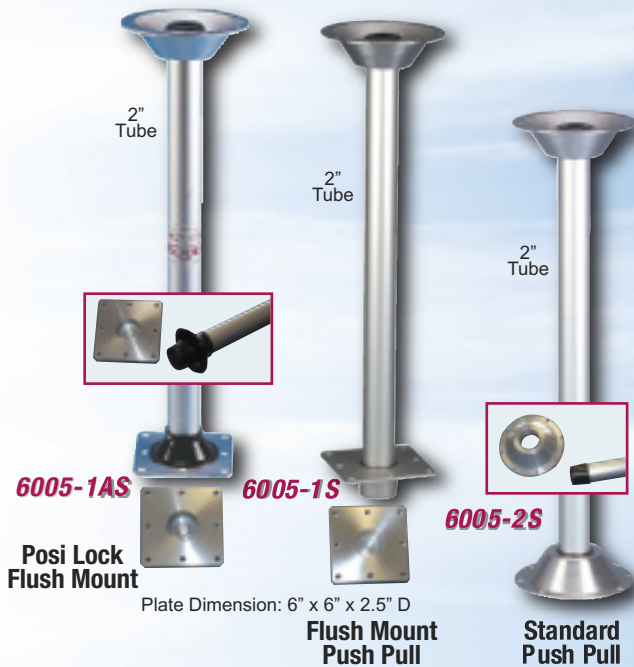

Table Tops "SALTWATER TOUGH"

Made of SURPASS® with 4 recessed cupholders table can be disassembled and stowed in minutes. Hardware attaches to molded-in holes on underside of table. Screws not included. Color: White (Custom colors available, call for quote upon request with high volume orders.)

- Oval Table Top only: 01-100W / Dimensions: 30"L, 18"W**
- Round Table Top only: 99-1613W / Dimensions: 21 1/2" dia.**

Table Top Packages: Includes two round table mounts (7 1/2" Dia.), a 26" table post, and a table top. If flush mounting of the floor plate is desired, specify Square Flush Mount Floor Plate (6005-1S)

- Round Table top Package: 99-1613WC**
- Oval Table top Package: 01-100WC**

Posi-Lock Table Top Packages: Includes one round table plate, one Posi-Lock square floorplate, a 26" Posi-Lock table post, and a table top

- Round Posi-Lock Table Top Package: 99-1613WP**
- Oval Posi-lock Table Top Package: 01-100WP**
- Deluxe Table Base: 93-5408**

This deluxe base goes from **21 1/2"** to **33 1/2"** in Height.



Patented "Pro-Flow" Technology

Schooling species of bait fish breathe from swimming while allowing water to pass over their gills. When held in the relatively small confines of a bait tank the fish suffer from a lack of oxygen as they can not swim fast enough to provide enough water to pass over their gills. A Pro Flow tank, with its patented directional flow water inlet baffle, allows water to enter evenly throughout the entire water column.

The slots in the baffle plate are cut at an angle, directing water against the side wall and creating a circular directional flow. This flow actually pushes fresh, oxygen-rich water over their gills - which keeps the fish swimming in the same direction and reduces collision, a major cause of scale loss in bait tanks. A no-clog drain baffle provides drainage over the entire water column.

The molded-in slosh guard keeps slosh and wet decks to a minimum. The light dome in the bottom of the tank eases nighttime access and prevents fish from hitting the walls in the dark. All tanks come with "L" mounting brackets, a durable molded cover (Model PF-42 has a solid poly cover) and are covered by a no-nonsense 1 year warranty.

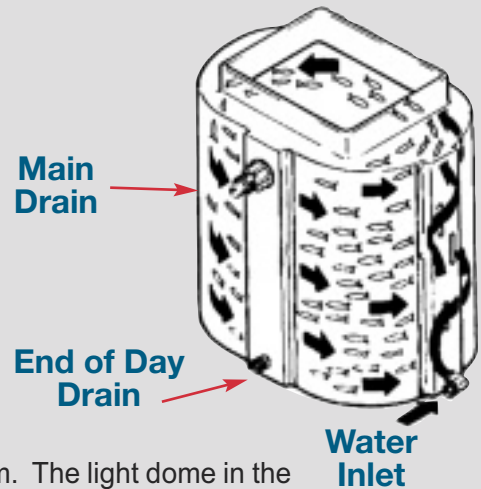

Oblong Pro Flow Bait Tanks

Space-saving oblong tanks available in 4 sizes come ready to fish. Connect to your bait pump and you're off for the fishing grounds. Models PF-22 and PF-32 are tall enough to drain over most outboard wells or mount on your swim step.

| Model#: | Capacity | Dia. X Ht. | WT Full/lbs. | WT Empty/lbs. |
|------------|----------|-----------------------|--------------|---------------|
| UT-13 | 13 gal. | 22.25" x 13.75" x 17" | 120 | 15 |
| PF-22 | 22 gal. | 17" x 22" x 24.25" | 201 | 18 |
| PF-32 | 32 gal. | 17.75" x 26" x 26.25" | 293 | 26 |
| PF-42-3 SP | 42 gal. | 21.75" x 29.25" x 32" | 453 | 38 |



Round Pro Flow Bait Tanks

Like all Pro Flow tanks the walls are smooth with baffles flush to the tank walls and nothing for the fish to collide with.

| Model#: | Capacity | Dia. X Ht. | WT Full/lbs. | WT Empty/lbs. |
|---------|----------|-----------------|--------------|---------------|
| PF-14 | 14 gal. | 16.25" x 23.25" | 131 | 14 |



Thru-Hull Bait & Washdown Pumps

You won't have to worry about salt rusting out this pump!

Its non-corrosive design will stand up to even the harshest environment. Low amperage per gallon of water output ratio is another real plus for boats with limited charging systems. All Kodiak pumps are whisper quiet, so you won't scare the fish away. Thru-Hull models feature full port 3/4" female pipe thread for direct thru-hull mounting. Models K-360 thru K1100 feature an additional threaded port for the hose attachment to a diaphragm type washdown pump.

| Model#: | Flow per min. | Average Draw | Suggested Bait Tank Size |
|---------|---------------|--------------|--------------------------|
| K360 | 3.4 | 1.8 | 7-16 |
| K500 | 5.0 | 2.3 | 17-30 |
| K700 | 8.8 | 3.5 | 30-40 |
| K1100 | 10.5 | 3.9 | 37-45 |



Kodiak's new cartridge-style pump shown to the right is available in 2 sizes, K500C and K700C Thru-Hull Mount and KB500C and KB700C Transom Mount. The motor snaps out of the water jacket, allowing fast cleanout of weeds and easy "on the water" replacement.

Angler Series Bait Tanks

Kodiak offers 4 standard bait tanks--a favorite among many anglers for many years. From our "easy to fit in tight places" KA-24 to our large-capacity KA-50, all the walls are smooth with nothing for the fish to collide with. Molded-in hand grips for easy handling and stainless steel mounting brackets. Tanks are easily accessorized with all our pumps and bait tank accessories.

| Model#: | Capacity | Dia. X Ht. | WT Full/lbs. | WT Empty/lbs. |
|---------|----------|-------------------------------|--------------|---------------|
| KA-24 | 24 gal. | 20" x 18" | 211 | 11 |
| KA-26 | 26 gal. | 30" x 16 ^{1/4} x 15" | 235 | 18 |
| KA-30 | 30 gal. | 23" x 17" | 264 | 14 |
| KA-50 | 50 gal. | 29" x 18" | 443 | 26 |



Pro Flow Transom Mount Tuna Tubes

Tuna Tubes are white on the outside, black on the inside. Bonito Tubes are solid black. The black interiors keep bait calm and alive longer. Tuna Tube has an 8" ID, is 24" long and will hold a tuna up to 20 pounds. Bonito Tube has a 5" ID and is 22" long. Quick disconnect transom mounting brackets are anodized and white powder-coated for long life. Small transom mount nuts mount to transom and brackets clip to nuts. Tubes are easily removed by removing one 3/16" detent pin. Tuna Tube sets come with a 6" insert for smaller bait. Plumbed for 1" hose. Double's are 2 sets of brackets mounted together and only require 4 mounting nuts on transom.

| Description | Double Tuna Tube | Single Tuna Tube |
|-------------|------------------|------------------|
| Model#: | PFTT-80-2 | PFTT-80 |

(Pump recommendation 700GPH or more)



Accessories

A. New LED Bait Tank Light

12-Volt light fits under tank and shines through bottom to illuminate tank. For night use. Model#: PF-001 (One size fits all Pro Flow tanks.)

B. Solid Cutting Board Lid

1/2" thick pebble finish cutting board lid
 Model#: PF-14C fits PF-14, PF-26, KA-24 and KA-30
 Model#: PF-22C fits PF-22
 Model#: PF-32C fits PF-17, PF-27, PF-32 and KA-26
 Model#: PF-52C fits PF-37, PF-42 and PF-52

C. Quick Disconnect Mounting Pad

4 Low Profile pads mount permanently to deck or swim platform, tank (L) brackets mount to pads. Tank and mounting (L) brackets can be quickly removed, black anodized aluminum with hardware. Model#: PF-003, PF-004 (Fits PF-52 tank, 6 pads)

E. Bait Tank Plumbing Kit Model#: KW1

For the do-it-yourselfer. All the fittings and instructions needed to build a standard live well.
 (A perfect match for all Kodiak Angler Series tanks.)

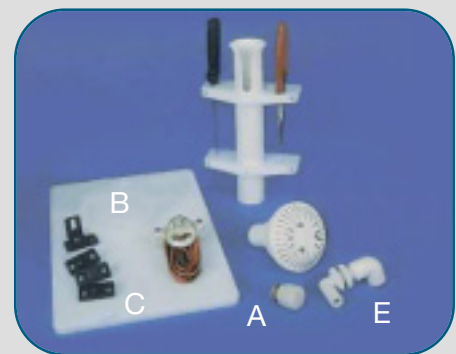

TRADITIONAL BAITWELLS



MODEL 36
84-1470



84-1470, 85-1640
85-1663



HIGH PROFILE
93-1334

CHEM-TAINER



BW-50, BW-100, BW-200
F.O.B. FLA ONLY

AquaWorld Bait Tanks are molded from rugged UV-stabilized SURPASS® resin which means years of use and incredible strength. Corners are rounded so bait cannot be trapped. As an added value, recessed cutting boards are made to fit flush in the top of each baitwell. Traditional Bait Tanks are not plumbed.

E-Z RELEASE MOUNTING BRACKET & PUMP

With the Aqua-World E-Z Release Mounting Bracket there is no priming bulb needed and no noise! Simply mount the E-Z Release Bracket underwater on the transom, flush with the bottom of the boat.

The submersible pump, in a cup assembly, slides into the bracket; snapping into a locking position. The pump is easily removed by pushing the Flex-Tab forward and pulling the pump out of the bracket.

Water is pumped through the filter slots and supplied directly to the bait tank or bag above. Pump includes a 6 foot wire leads and accepts 3/4" ID hose. (EZ-1100 accepts 1 1/8" ID hose or adapts to standard garden hose thread with included snap-on fitting.)



| Model #: | GPH | Tank Cap. Gal. | Amp. Draw |
|----------|-----|----------------|-----------|
| EZ-360 | 360 | 20 | 2.5 |
| EZ-500 | 500 | 30 | 2.5 |
| EZ-700 | 700 | 45 | 4 |



Shingle Creek **OUTFITTERS**

A name that can be associated with the most portable, convenient, durable, versatile and attractive bait containers bait tanks and bait wells made today.



The Toho-Rig - Large Capacity Portable Livewell

The Toho-Rig is a large capacity portable Livewell System made of incredibly durable Surpass® resin. A complete aeration system includes a 12-volt hi-capacity pump and a custom spray bar and hose. Over 640 square inches of surface area provides maximum oxygenation to keep baits healthy and fish lively. Double-walled lids have molded-in cupholders, lure trays, a 16" measuring rule and a large versatile center storage compartment.

A removable perforated divider allows baits to be kept separate from fish.

Special "hook and strap" supports adjust to keep the unit snugly secure in a wide variety of jon boats, row boats, skiffs and vee hulls.

Dimensions:

44"W, 16"D, 13"H (31" bottom width)

Available in gray, green or blue.

All lids are gray. Toho-Rig

Product #:

Gray 978000-Y Blue: 978000-E Green: 978000-N.

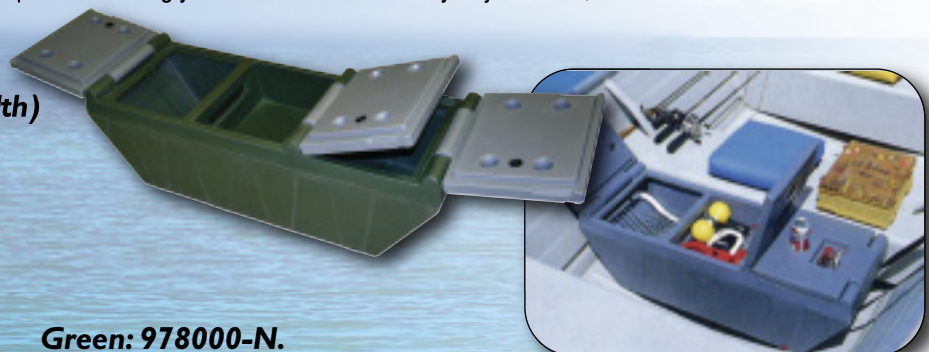

~ 19 ~

Check out the collection of boat seating and accessories we offer.