

TITAN

PROFESSIONAL HAND TOOLS

YOUR GO-TO
CATALOG
FOR WHAT'S
NEW AND HOT!

LOW-
PROFILE
SOCKET SETS



SEAL & O-RING
REMOVER
4PC SET

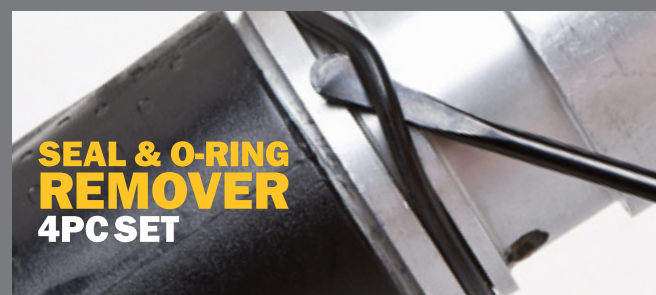

SEAL & O-RING REMOVER 4PC SET



Prevents damaging seal or delicate finished surfaces

4pc Seal & O-Ring Remover Set

17004

- Allows for easy removal of seals and o-rings without damaging the seal or the finished surface
- Set Includes: (2) Contoured Tip & (2) Spoon Tip Lengths: 5-1/2" & 8-1/2"



INCLUDES:
(2) CONTOURED SPOON
TIP & (2) STRAIGHT
SPOON TIP REMOVERS



13" Heavy Duty Hand Riveter

15050

- Heavy Duty
- Wrench and nosepieces store in handles
- Compound lever action reduces operator fatigue
- Spent Mandrel Cup
- Can be used with Stainless Steel Rivets

Rivet Sizes: 1/8, 5/32, 3/16, & 1/4"



SPENT MANDREL CUP CATCHES USED RIVET PIECES

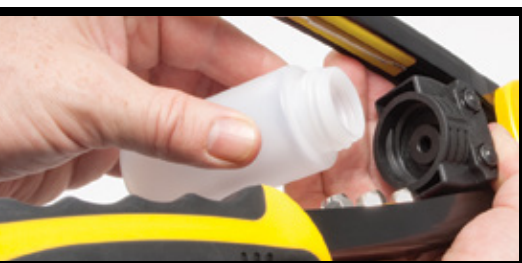

CAN BE USED WITH STAINLESS STEEL RIVETS



NOSEPIECES STORE CONVENIENTLY IN HANDLE

10" Rivet Gun with Rivets

15052

- Includes 60 Rivets
- Anti-slip cushion grip handle
- Great for use in hard to reach places
- 4 Interchangeable Nosepieces: 3/32, 1/8, 5/32, & 3/16"



COMPACT DESIGN COMBINED WITH **MASSIVE FORCE**

ANGLE GRINDERS

4-1/2" 4.3Amp Angle Grinder

22514

- Voltage: 120 V, 60Hz
- Amps: 4.3
- No Load Speed: 12,000 RPM
- Right or left handle mount
- Metal gear housing
- 5/8" Arbor
- 6' Electrical cord
- Lock-on safety switch



Right or left handle mount

Voltage:	AMPS:	No Load Speed:	Handle Mount:
120 V, 60Hz	4.3	12,000 RPM	Right and Left

4-1/2" 8Amp Angle Grinder

22525

- Voltage: 120 V, 60Hz
- Amps: 8
- No Load Speed: 11,000 RPM
- Right, top or left handle mount
- Metal gear housing
- 5/8" Arbor
- 6-1/2' Electrical cord
- Lock-on safety switch



Right, left or top handle mount

Voltage:	AMPS:	No Load Speed:	Handle Mount:
120 V, 60Hz	8	11,000 RPM	Right, Left and Top

LOW-PROFILE SOCKET SETS



Low profile sockets & ratchets provide at least an additional 3/4" of clearance

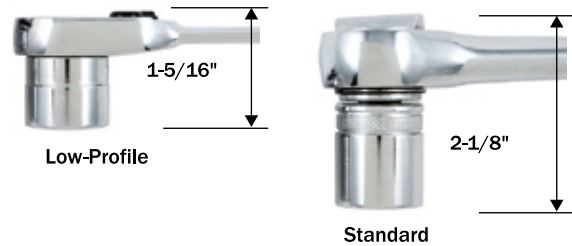

LOW-PROFILE SOCKET SETS AVAILABLE

22pc 3/8" Dr. Fractional/Metric Low Profile Socket Set

68003

- Low-profile 3/8" Dr. ratchet
- Packaged in blow mold case
- 3/8" Dr. sizes include:

SAE	1/4, 5/16, 3/8, 7/16, 1/2, 9/16, 5/8, 11/16 & 3/4"
Metric	8, 9, 10, 11, 12, 13, 14, 15, 16, 17, 18 & 19mm

23pc 1/4" Dr. SAE/Metric Socket Set

63003

- Low-profile 1/4" Dr. ratchet
- Packaged in blow mold case
- 1/4" Dr. sizes include:

SAE	5/32, 3/16, 7/32, 1/4, 9/32, 5/16, 11/32, 3/8, 7/16, 1/2 & 9/16"
Metric	4, 5, 6, 7, 8, 9, 10, 11, 12, 13 & 14mm

Low Profile Impact Bit Sockets Feature:

- Impact Grade
- Rail storage rack
- Available for the following fasteners: Tamper Resistant Star, Star, XZN/Triple Square, Hex Metric and Hex SAE



9pc Triple Square Bit Set

16138

- XZN/Triple Square sizes include:

1/4" Dr.	M4, M5, M6 & M8
3/8" Dr.	M10 & M12
1/2" Dr.	MT14, MT16 & MT18

10pc Star Bit Set

16142

- Star sizes include:

1/4" Dr.	T10, T15, T20, T25, T27 & T30
3/8" Dr.	T40, T45, T47 & T50

10pc Star Bit Set

16143

- Tamper Resistant Star sizes include:

1/4" Dr.	TT10, TT15, TT20, TT25, TT27 & TT30
3/8" Dr.	TT40, TT45, TT47 & TT50

9pc SAE Hex Bit Set

16140

- Hex sizes include:

1/4" Dr.	1/4, 5/16 & 3/8"
3/8" Dr.	7/16, 1/2, 9/16, 5/8, 11/16 & 3/4"

9pc Metric Hex Bit Set

16141

- Metric sizes include:

1/4" Dr.	6, 7, 8 & 10mm
3/8" Dr.	12, 14, 17, 18 & 19mm

POWERFUL
IMPACT GRADE



1/4" & 3/8" DRIVE SLIM HEAD RATCHET SOCKET SETS



All Sets Feature:

- Professional Slim Head Ratchet
- Sturdy Storage/Carry Case

The slim head ratchets head are considerably smaller compared to a traditional ratchet head allowing for greater clearance in confined areas.

Knurled sockets and accessories reduces slippage when turning with fingers



Slim head ratchets have a 60 thread tooth count

40pc 3/8" Dr. SAE/Metric Socket Set

68203

- 3" & 6" Extensions
- 5/8" Spark Plug Socket
- Sizes Included:

SAE 6 Point Standard Sockets	1/4, 5/16, 3/8, 7/16, 1/2, 9/16, 5/8, 11/16 & 3/4"
Metric 6 Point Standard Sockets	10, 11, 12, 13, 14, 15, 16, 17, 18 & 19mm
SAE 6 Point Deep Sockets	3/8, 7/16, 1/2, 9/16, 5/8, 11/16, 3/4, 13/16 & 7/8"
Metric 6 Point Deep Sockets	10, 11, 12, 13, 14, 15, 17 & 19mm



3/8" Dr. Socket Sets

68001 - 21pc SAE

6 Point Sockets	1/4, 5/16, 3/8, 7/16, 1/2, 9/16, 5/8, 11/16 & 3/4"
6 Point Deep Sockets	3/8, 7/16, 1/2, 9/16, 5/8, 11/16, 3/4, 13/16 & 7/8"
Extensions	1-1/2" & 6"



68201 - 22pc Metric

6 Point Sockets	10, 11, 12, 13, 14, 15, 16, 17, 18 & 19mm
6 Point Deep Sockets	10, 11, 12, 13, 14, 15, 17 & 19mm
Extensions	3" & 6"
Spark Plug Socket	5/8"

1/4" Dr. Socket Sets

66001 - 21pc SAE

6 Point Sockets	3/16, 7/32, 1/4, 9/32, 5/16, 11/32, 3/8, 7/16 & 1/2"
6 Point Deep Sockets	1/4, 9/32, 5/16, 11/32, 3/8, 7/16 & 1/2"

66201 - 21pc Metric

6 Point Sockets	4, 5, 6, 7, 8, 9, 10, 11 & 12mm
6 Point Deep Sockets	6, 7, 8, 9, 10, 11 & 12mm

Both Feature:

- 6" Spinner Handle
- 2" & 6" Extensions
- Universal Joint



SAE & METRIC UNIVERSAL SOCKET SETS ON RAIL

FULL POLISH



CHROME
VANADIUM
CONSTRUCTION

7pc SAE 1/4\" Dr. Universal Socket Set

17409

• Set Includes:

SAE	3/16\", 1/4\", 5/16\", 3/8\", 7/16\", 1/2\" & 9/16"
-----	--

Bulk Item #'s for 17409:

66336	3/16"
66337	1/4"
66338	5/16"
66339	3/8"
66340	7/16"
66341	1/2"
66342	9/16"

12pc MM 1/4\" Dr. Universal Socket Set

17410

• Set Includes:

Metric	5mm, 5.5mm, 6mm, 7mm, 8mm, 9mm, 10mm, 11mm, 12mm, 13mm, 14mm & 15mm
--------	--

Bulk Item #'s for 17410:

66325	5mm
66324	5.5mm
66326	6mm
66327	7mm
66328	8mm
66329	9mm
66330	10mm
66331	11mm
66332	12mm
66333	13mm
66334	14mm
66335	15mm

7pc SAE 3/8\" Dr. Universal Socket Set

17411

• Set Includes:

SAE	3/8\", 7/16\", 1/2\", 9/16\", 5/8\", 11/16\" & 3/4"
-----	--

Bulk Item #'s for 17411:

68350	3/8"
68351	7/16"
68352	1/2"
68353	9/16"
68354	5/8"
68355	11/16"
68356	3/4"

10pc MM 3/8\" Dr. Universal Socket Set

17412

• Set Includes:

Metric	10mm, 11mm, 12mm, 13mm, 14mm, 15mm, 16mm, 17mm, 18mm & 19mm
--------	---

Bulk Item #'s for 17412:

68340	10mm
68341	11mm
68342	12mm
68343	13mm
68344	14mm
68345	15mm
68346	16mm
68347	17mm
68348	18mm
68349	19mm

Spot Spray Non-Aerosol Sprayers

19419 - Red

19421 - Red & Blue (Twin Pack)

- Color-coded for easy recognition

Features:

- 80-150psi operating pressure (max pressure: 200psi)
- Refillable
- Not for use with paint products
- Eliminates dangerous, harmful propellants
- No more aerosol disposal issues
- Maximum capacity 32oz
- Available in a single or twin-pack
- Eco friendly

**SPOT SPRAY
NON-AEROSOL
SPRAYERS**

Maximum
capacity 32oz



Easy to Identify color coded
canisters and labels

5.5MM DIAMETER LED CAMERA

INCLUDES 3FT. FLEXIBLE WATER-RESISTANT SCOPE

5.5mm Flexible Inspection Camera

15054 - 5.5MM with storage case

- 2.7" TFT LCD Screen
- Resolution: VGA (300,000 pixels)
- 180° image rotation

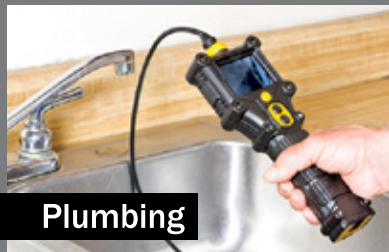

Plumbing



Engine Work

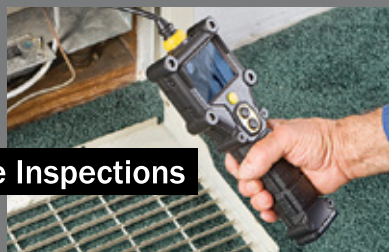

Home Inspections



TITAN's Flexible Inspection Camera's also feature:

- Ultra clear resolution LCD screen
 - Zoom in 2X
- Operation time: 4-5 hours
 - Drop resistant
- 5 hour constant use battery life
 - Includes: (4) AA Batteries
 - Carrying case included

With a drop resistant protective case, the 5.5mm Flexible Inspection Camera is an essential tool for your collection!

3FT. FLEXIBLE WATER-RESISTANT INSPECTION CAMERAS



8mm Flexible Inspection Camera

15059

- 3.5" TFT LCD Screen
- Inspect in walls for mold, electrical wire, pipe location, heaters, and A/C ducts
- View inside or around automotive engines and transmissions
- 8mm diameter camera
- 3ft water resistant flexible probe
- 180 degree image rotation
- LED brightness control
- Includes (4) AA batteries



Automotive

8.5mm Flexible Inspection Camera

15053

- 2.7" TFT LCD Screen
- Resolution: VGA (300,000 pixels)
- Zoom in 2X
- Operation time: 4-5 hours
- Includes (4) AA Batteries



The 3ft. flexible water-resistant probe allows for inspection in every location, wet or dry!

PROFESSIONAL AND TRADESMAN MECHANICS TOOLS

Professional Mechanics Bench Vises

22011 - 4"

22014 - 5"

22016 - 6"

- Professional Grade
- Forged Steel Beam
- Replaceable hardened steel jaws
- Serrated pipes jaws
- Incorporated anvil
- Swivel base with position lock
- Replacement Jaws available

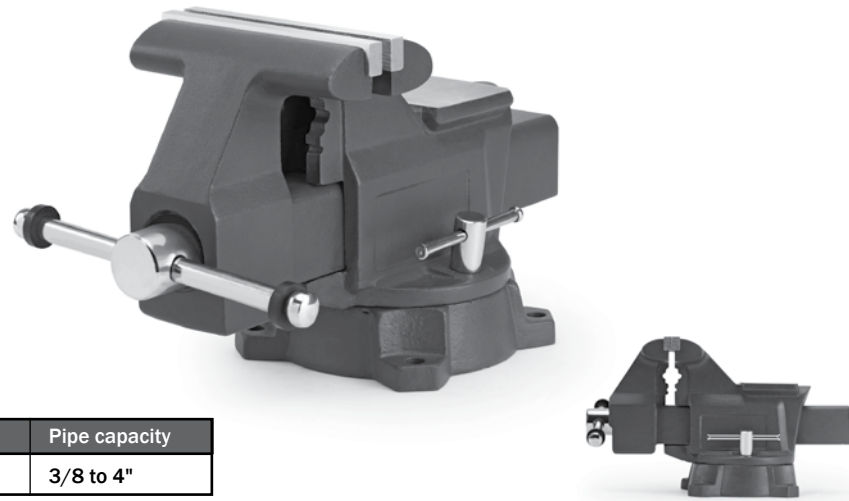

Jaw width	Jaw opening	Throat depth	Pipe capacity
5"	4-3/4"	6"	3/8 to 4"

Tradesmans Mechanics Bench Vises

22010 - 4"

22013 - 5"

22015 - 6"

- Hardened Steel Jaws
- Precision cast iron beam
- Replaceable jaws
- Incorporated anvil
- Swivel base with position lock
- Replacement Jaws available

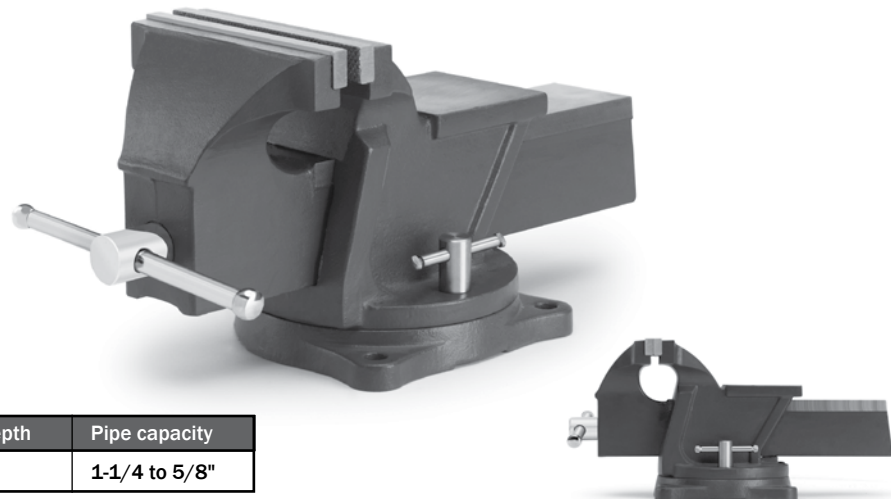

Jaw width	Jaw opening	Throat depth	Pipe capacity
4"	4-1/4"	4-1/2"	1-1/4 to 5/8"

5" Swivel Vise

22012

- Hardened steel jaws rotate 360 degrees
- Jaws rotate for clamping at any angle
- Precision cast iron beam
- Replaceable jaws
- Incorporated anvil
- Serrated pipe jaws
- Jaw width: 5"
- Jaw opening: 5"
- Throat depth: 8-1/2"
- Pipe capacity: 3/8 to 5"
- Replacement Jaw available: Item # 22005

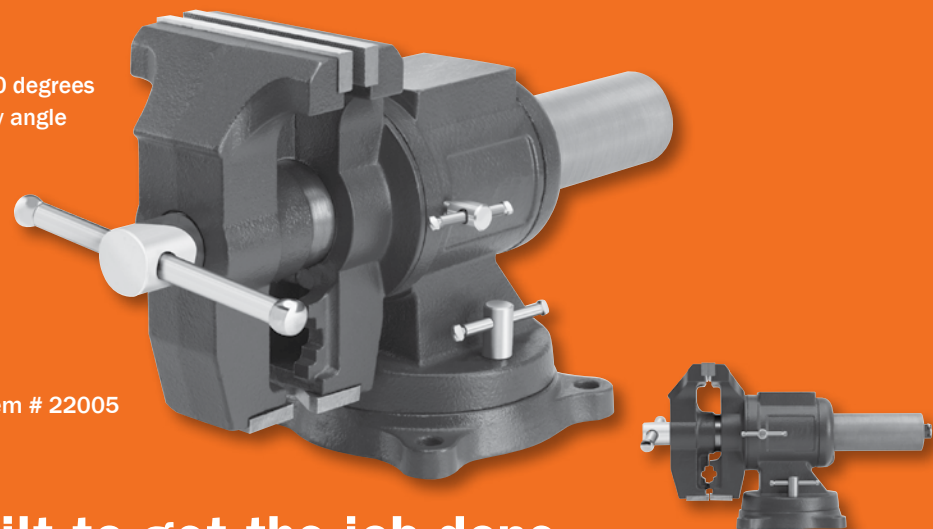

PROFESSIONAL TRADESMAN 8" BENCH VISE

8" Heavy Duty Bench Vise

22018

- Anvil size: 4 X 3.5"
- 210 degree swivel base
- Jaws rotate for clamping at any angle
- Precision cast iron beam
- Replaceable jaws
- Incorporated anvil

Jaw width	Jaw opening	Throat depth	Pipe capacity
8"	7.5"	4.5"	13.5-100"

Pipe jaws designed to grip pipe securely

Hardened replaceable jaws

Steel handle with rubber anti-pinch rings

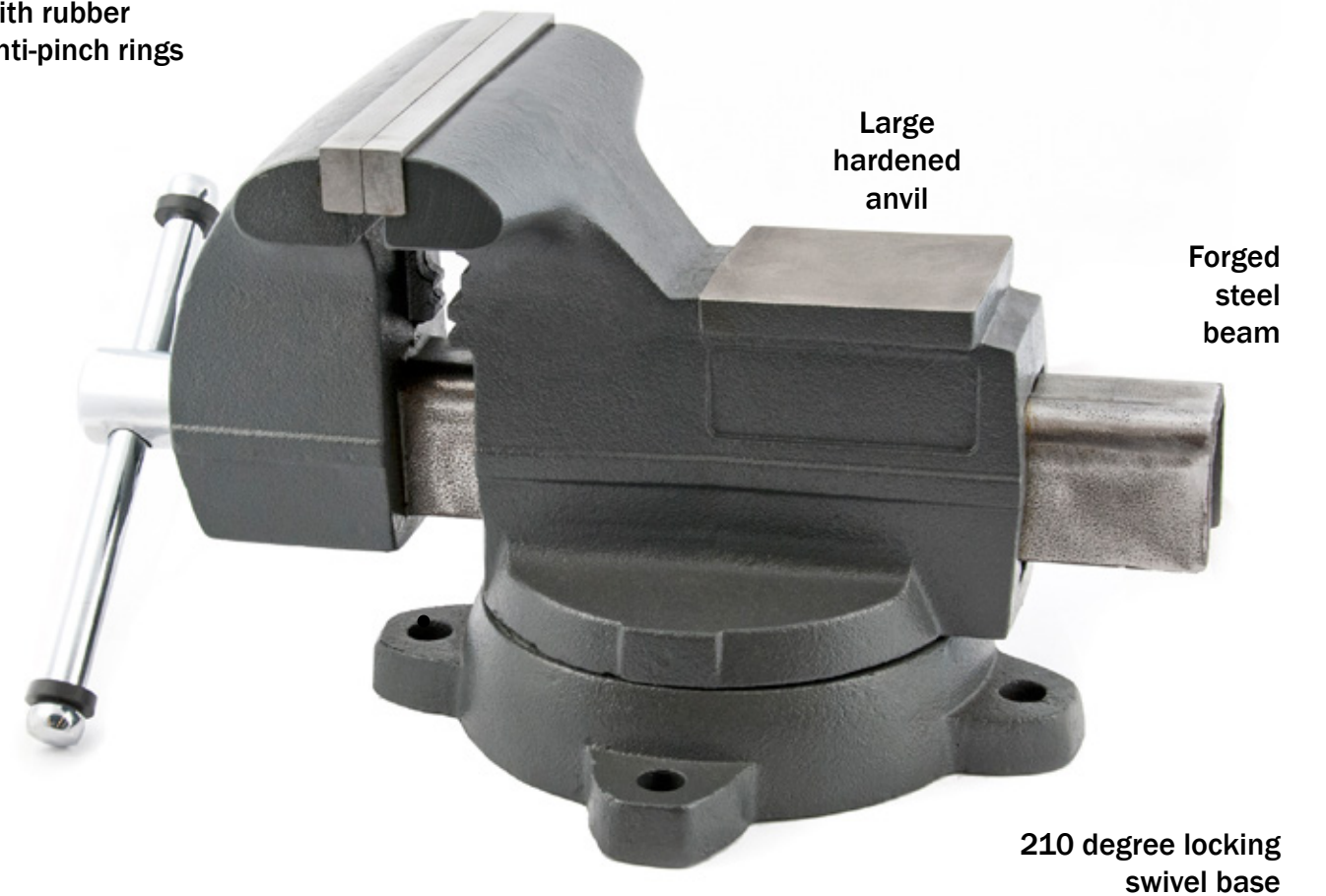

135 AMP GAS & GASLESS MIG WELDER & ACCESSORIES KIT

135 Amp Gas & Gasless MIG Welder Kit

41187

- 20%@90 Amp, 115 V
- 22-135 Amp motor ETL Certified
- Welding helmet to ensure eye and face protection
- Welding gloves to protect against splatter
- Step-less wire speed control
- Inner cooled for increased performance
- Electronic gas valve
- Easy read gauges
- Adjustable Gas regulator
- Operates on 115V Household Current
- Multiple Voltage Settings



MIG TORCH WITH 8FT LEAD
GROUND CLAMP WITH 10FT LEAD

WELDING CART TO HELP STORE
AND ORGANIZE
WELDER & WELDING
ACCESSORIES

Accessories Included:

- Fleece lined, premium leather Welding Gloves
- Solar Powered Auto Darkening Welding Helmet
- Flux core 1lb MIG wire
- 2lbs Welding wire
- Sturdy Steel Structure cart

ADDITIONAL WELDERS AVAILABLE

135 Amp Gas & Gasless MIG Welder

41186

- 20%@90 Amp, 115V
- 22-135 Amp motor
- ETL Certified
- MIG Torch with 8ft lead
- Ground Clamp with 10ft lead
- Thermal overload protection
- 4-step voltage settings
- Stepless wire speed control
- Adjustable regulator/flow gauge
- Inner cooled for increased performance
- Electronic gas valve



175 Amp Gas and Gasless MIG Welder

41188

- 20%@135 Amp, 230V 60 Hz
- 35-170 Amp motor ETL Certified
- MIG torch with 8ft lead
- Ground clamp with 10ft lead
- Thermal overload protection

- Multiple voltage settings
- Stepless wire speed control
- Adjustable regulator/flow gauge
- Adjustable gas regulator



GAS AND GASLESS

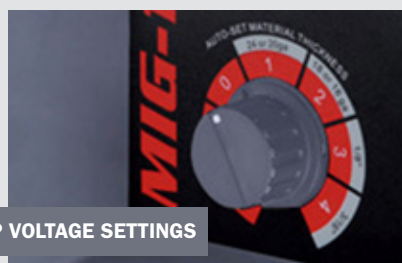

4-STEP VOLTAGE SETTINGS

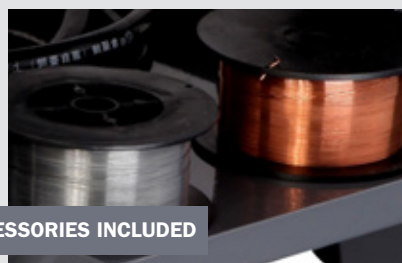

ACCESSORIES INCLUDED

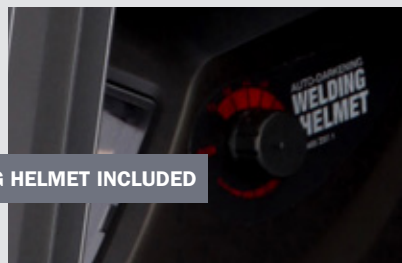

WELDING HELMET INCLUDED

AUTOMATICALLY DARKENS IN 1/30,000 OF A SECOND

Welding Helmets feature:

- Durable, lightweight material is corrosion resistant and flame retardant
- Ultra high performance filters protect against UV & IR
- 2.17 x 3.86" viewing area
- Returns to normal when welding stops with dark to clear adjustments available
- Variable shades from DIN 9 to DIN 13
- Special turnover headband mechanism allows for greater comfort and reduces fatigue
- Utilizes high performance solar cells with 2 built-in 3V lithium batteries as power back-up
- Complies with DIN, ISO, EN safety standards and ANSI Z87.1-2003 standards

41279



Available Designs:

- 41279 - Skull Wrecker
- 41278 - Pirates at Sea

EXTRA LARGE VIEWING AREA

2.17 x 3.86"
viewing area

41278

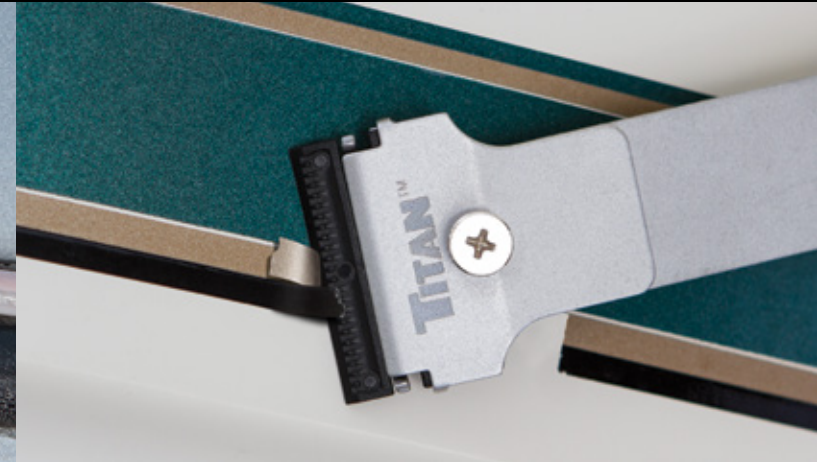
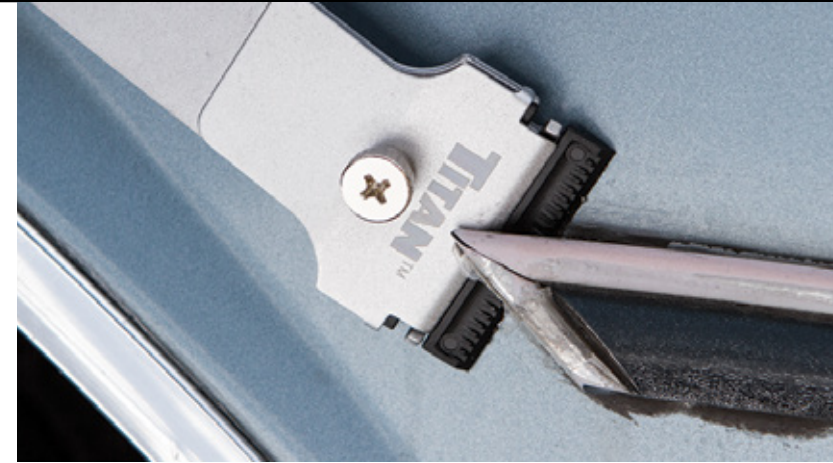

Non-Marring Scraper Blades

12038

- Ideal for scraping labels and decals from glass, windshields, etc.
- 2 Individual packs containing (10) Non-Marring Scraper Blades
- Polymere Construction
- Fits most common scrapers
- Each blade features two usable edges

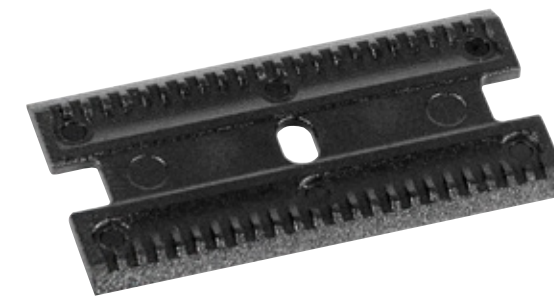

Each blade features two usable edges

22pc Scraper Set with Non-Marring Blades

17008

- Set Includes:
- (11) 0.020" Razor Blades
- (10) Non-Marring Scraper Blades
- (1) 9" Razor Scraper
- Non-scratching/non-marring scraper blades are ideal for scraping finished surfaces
- 9" Razor scraper accepts standard single edge razor blades and non-marring blades

Fits most common scrapers



AUTO BODY REPAIR TOOLS & ACCESSORIES



7pc Auto body Hammer Set

15084

- Heat-treated, dropped forged steel dollies and hammers
- Fiberglass hammer handles with non-slip grip
- Includes: bumping hammer, pick & finish hammer, reverse curve hammer, utility dolly, double end dolly, shrinking dolly, curve dolly, blow mold case

Straight Finishing Hammer

15079

- Drop forged steel head
- Rubber grip handle
- Square head, flat face, blunt head, chisel point

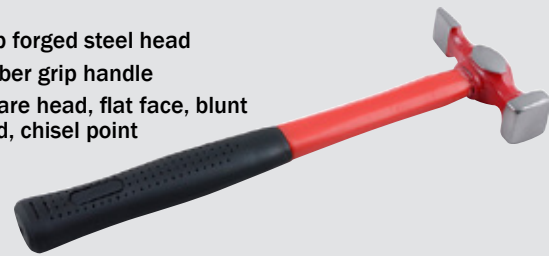

Shrinking Hammer

15080

- Drop forged steel head
- Mirror polished
- Rubber grip handle
- For all-around work and fast finishing

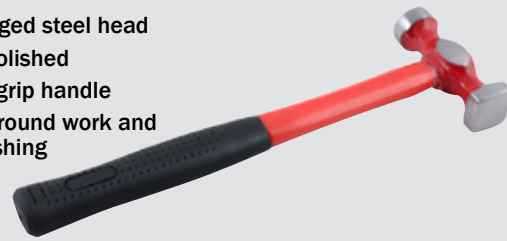

Pick Finishing Hammer

15081

- For finishing
- Long-reach, thin point for low spot on low-crown panels



8oz Rubber Mallet

15082

- Double-faced solid rubber head
- Textured non-slip handle



Heel Dolly

15085

- For smoothing dings and dents in sheet metal or steel

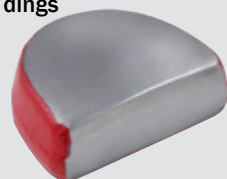

Wedge Dolly

15086

- Slender general purpose dolly
- Used for beads or flanges on fenders
- Thin edge useful for corners



General Purpose Dolly

15087

- Ideal for shaping and molding metal
- Several differently crowned working faces



10" Flat Body Filler Shaper File Blade

15072

- Easily removes and shapes partially cured body filler
- For filing and shaping flat or contoured auto body panels



10" Round Body Filler Shaper File Blade

15088

- Half-round
- Easy to use
- For auto body shaping



10" 3 Position File Holder

15075

- 3-position file holder
- 10" flat blade
- Planes, shapes, files and shaves



Filler Scoop

15074

- For easy scooping of auto body filler

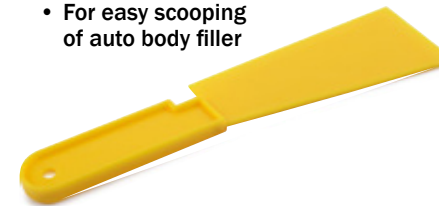

3 Pack Spreader

15073

- Great for spreading and scraping muds, pastes, spackling, grout
- Recommended for dry walling, flooring, and tiling operations
- Includes 3 plastic spreaders



20pc 4" Plastic Spreaders

15089

- Use for auto body repair putty, fiberglass resin, and other compounds
- Economical for small and large jobs



Suction Cup Dent Puller

15071

- Easily pops dented hoods and fenders into place
- Also works as a glass holder



Locking Suction Cup Dent Puller

15090

- Double handle locking suction cup dent puller
- Designed for auto body repair



Safety Goggles

15070

- Impact Resistant
- Elastic band for comfort and fit



Dent Puller

15077

- Repairs dents quickly
- Fix dents like a pro
- Durable



Flexible Sander

15078

- Flexible design allows for optimal sanding of flat & curved surfaces
- Ergonomic dual handle design for comfort and maximum control



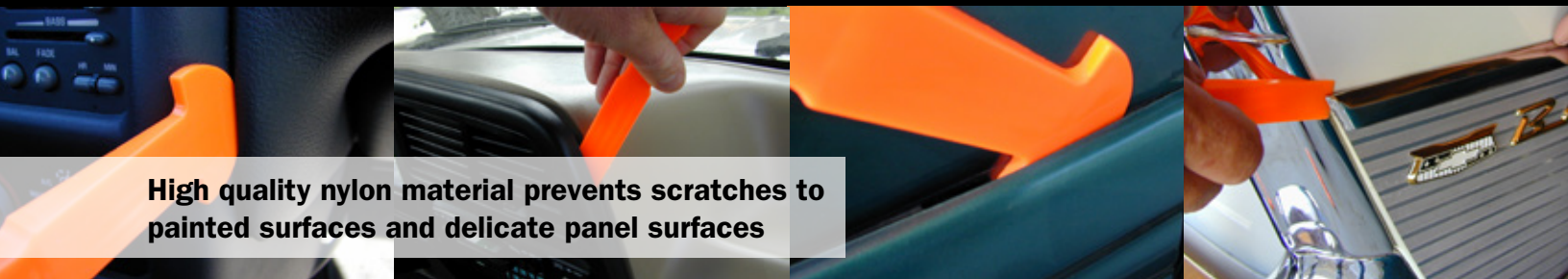

High quality nylon material prevents scratches to painted surfaces and delicate panel surfaces

3pc Multi Wedge Interior Trim Panel Tools

15047

- Includes 3 interior wedge tools:
 - (1) 5" x 7/8" x 1/2" short wedge
 - (1) 7" x 1" x 5/8" long wedge
 - (1) 7" x 2" x 5/8" curved tip wedge

6pc Multi Wedge Interior and Exterior Trim Panel Tools

15048 - 6pc

- Includes (3) interior and (3) exterior wedge tools:
 - (2) 5" x 7/8" x 1/2" short wedge
 - (2) 7" x 1" x 5/8" long wedge
 - (2) 7" x 2" x 5/8" curved tip wedge

All Feature:

- Specially designed slim profile
- Shaped for many different applications such as removing dashboards, air vents, door panels, door locks, electronic seat controls, seat levers, center consoles, gear shifter and more
- High quality nylon material prevents scratches to painted surfaces and delicate panel surfaces
- Orange wedges are made of a flexible polyethylene material and most commonly used for interior trim
- Black wedges are made of a high impact polycarbonate material and most commonly used for exterior trim



Jumbo Wedge

15049

- High quality nylon material prevents scratches to painted surfaces and delicate panel surfaces
- ABS Plastic Wedge
- Lightweight
- Great for leveling, aligning, and prying apart materials
- Ideal for use in larger, heavier jobs such as framework and installing doors
- Ships in 12pc counter display

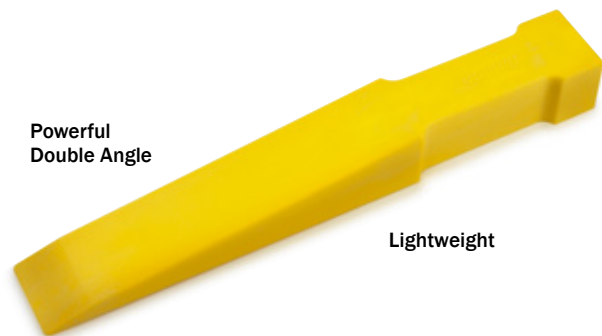

Ideal for use in larger, heavier jobs such as framework and installing doors



Pocket Flashlight

36006

- 1 Watt LED bulb
- Generates 90 Lumens of light
- Includes 2 AAA Duracell batteries
- Aluminium Construction
- Diameter: 5/8"
- Overall length: 5.5"



3pc Mini Electrical Tool Set

11476

- Set Includes: Cutter, Stripper, and Crimper
- Overall length of tools: 5-1/2"
- For hard to reach applications
- Spring loaded to reduce fatigue

Comfortable TPR handles for maximum grip



Cutting Capacity: 30-10Awg

Stripping Capacity: 22-10Awg

Crimping Capacity: Insulated Terminals from 22-10Awg



GENERAL HAMMERS

5pc General Hammer Set

63125

- Comfortable, textured handles for handling ease

Set includes:

- (1) 16 oz. Ball Pein Hammer (Item #63316)
- (1) 32 oz. Ball Pein Hammer (Item #63024)
- (1) 32 oz. Rubber Mallet (Item #63232)
- (1) 3 lb Sledge Hammer (Item #63000)
- (1) 3 lb Cross Pein Hammer (Item #63004)



PROFESSIONAL HAND TOOLS

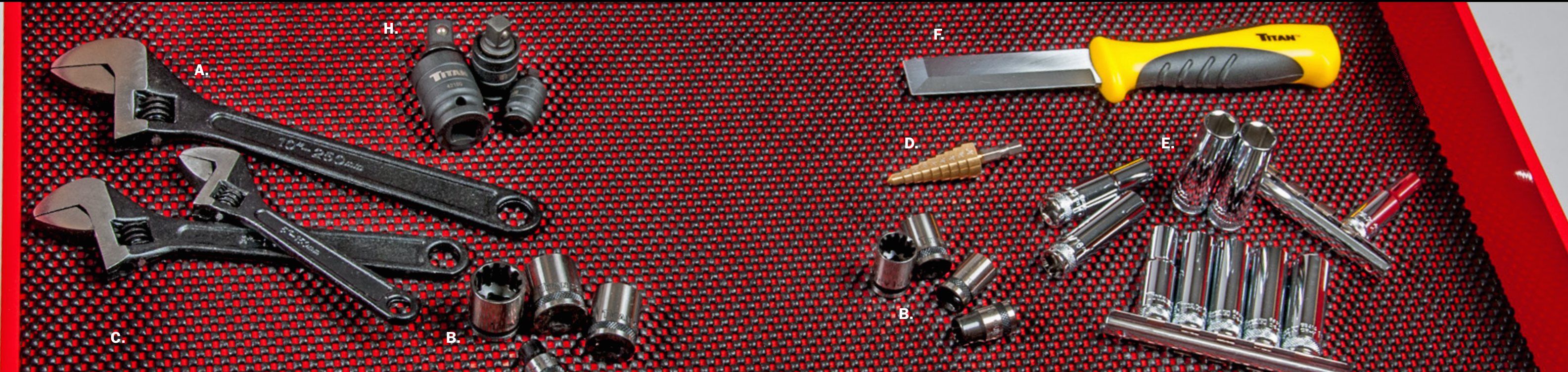

3pc Adjustable Wrench Set

203

- Sizes Includes: 6", 8" & 10"
- Drop forged Steel
- Heavy Duty
- Limited Lifetime Warranty



8pc Metric 3/8" Dr. Spline Socket Set

15204

Metric	8, 10, 12, 13, 14, 17, 18 & 19mm
--------	----------------------------------

- High contrast markings make it easy to find the right size
- Universal spline design to fit into different types of fasteners
- Chrome vanadium construction



Tool Box Drawer Liner

30931

- 16 x 8"
- Non-adhesive gripping fabric
- Washable
- Easily cuts to size
- Stops sliding and rattling



Step Drill Bit

16504

- Drill 9 different hole sizes with one bit: 1/4" - 3/4"
- Titanium coating extends life of the bit
- Hex Shank eliminates slippage



3/8" Dr. 5pc Deep Socket Sets

33051 - SAE

33052 - Metric

SAE Sizes:	3/8", 5/16", 7/16", 1/2" & 9/16"
Metric Sizes:	10, 11, 12, 13 & 14mm

Chisel-Tip Wrecking Knife

17108

- 4" Blade
- Stainless steel construction
- Strikeable end
- Chisel-tipped
- Includes holster
- Can be used for: chiselling, prying, scraping, coring, cutting, and more



10" Adjustable Spud Wrench

211

- Chrome Vanadium construction
- Black oxide finish resists corrosion
- Opens to a maximum of 1-1/4"
- Overall length: 12"



3pc Locking Impact U-Joint Set

16151

Drive Size	1/4", 3/8" & 1/2"
------------	-------------------

- Impact Grade
- Packaged in EVA foam



IMPACT POWER BIT TOOLS & ACCESSORIES

IMPACT BIT SETS

Sets Feature:

- Available in a variety of sizes
- Impact grade
- Fits standard 1/4" hex drivers



3pc 1" Impact Bit Set

16228

- Sizes Include:
- (1) #1 Phillips
- (2) #2 Phillips

3pc 1" Impact Bit Set

16229

- Sizes Include:
- (1) #3 Phillips
- (2) #2 Phillips

10pc 2" Impact Bit Set

16232

- Sizes Include:
- (1) 1/4" Slotted
- (5) #2 Phillips
- (1) #1 Phillips
- (1) #3 Phillips
- (1) T15 Star
- (1) T20 Star

10pc 2" Impact Bit Set

16233

- Sizes Include:
- (6) #2 Phillips
- (2) #1 Phillips
- (2) #3 Phillips

IMPACT POWER BIT SETS

Sets Feature:

- Available in a variety of sizes
- Impact grade
- Fits standard 1/4" hex drivers



5pc 1" Phillips Impact Power Bit Set

16205 - 5pc 1"

- Sizes include:
- (5) 1" #2 Phillips bits

5pc 2" Phillips Impact Power Bit Set

16206 - 2pc 2"

- Sizes include:
- (2) 2" #2 Phillips bits



Swivel Bit Holder

16227

- 30 degree swivelling head
- 1/4" hex shank
- Locks into stationary position



Right-Angle Drill Attachment

16235

- 90 Degree 1/4" Bit Driver with 360 Degree Swivel Handle
- 1/4" Hex Shank
- 1/4" Chuck Bit Holder
- Smooth precision turning during 90 degree position



2pc 2" Magnetic Driver Bit

16234

- #2 Phillips
- Magnetic holder
- Bit size PH2



SPLINE DRIVE WRENCHES

Spline Wrenches Feature:

- SAE and Metric Sizes
- Easily identifiable sizes
- Spline Drive for use on multiple fasteners



SAE & Metric Spline Wrenches

SAE Sizes		Metric Sizes	
81356	5/16"	81363	8mm
81357	3/8"	81364	10mm
81358	7/16"	81365	11mm
81359	1/2"	81366	13mm
81360	9/16"	81367	14mm
81361	5/8"	81368	15mm
81362	11/16"	81369	17mm



Digital Torque Adaptor

23154

- Calibration device for torque wrenches
- Includes a calibrating block
- Converts any ratchet into a torque measuring tool
- Use to re-calibrate any type of torque wrench
- 1/2" Dr.
- UOM: Kg-CM, Kg-M, In-lb, Ft-lb, and N-m
- Range: 30-150ft-lbs
- LED backlight
- Swivels 240 degrees
- Flip screen (180 degrees)
- 10 Memory settings
- Contains (1) DC 3V, CR2032 battery





12 bowl rack

98181

- Holds 12 merchandisers
- (6) Small
- (6) Large

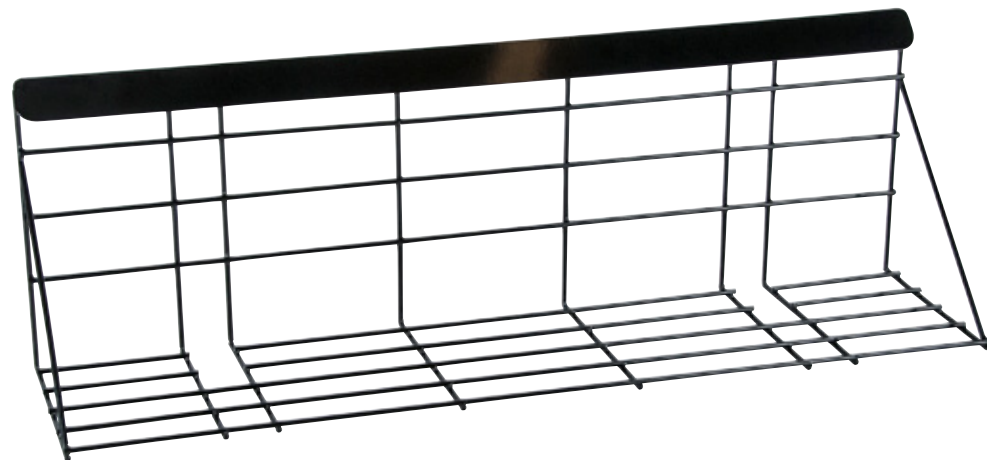

4 bowl rack

98182

- Holds 4 merchandisers
- (2) Small
- (2) Large



Large Merchandisers

Small Merchandisers

Item#	Description
32995	Breakaway Knife
33001	1/2" x 16' Thread Seal Tape
33003	Single Edge Scraper
33004	Nail Brush
33006	3pc Multi Color Aluminum D Ring
33007	3/4" x 60' Electrical Tape
33008	Battery Terminal Cleaner
33022	12pc Key Ring Set
33032	1in C-Clamp
33036	3ft. Key Ring Tape Measure
33037	48in Key Reel
33040	Folding Magnifying Glass

Item#	Description
32990	Brass Padlock
33033	Tweezers
33034	3 Key Chain D-Ring
32991	Multi-Purpose Key Chain
33000	Nail Clipper
33002	Spark Plug Gap Gauge
33005	Lighted Folding Knife with Key Chain
33015	4-in-1 Pocket Screwdriver
33039	3pc 3/16" Quick Link Set
33043	Key Ring Flashlight
33046	2-1/2" Utility Knife with Key Chain
33048	10-50psi Tire Gauge



Nail Clipper

32002

- 2" Long
- Includes file with curved tip
- Beaded chain



D Ring Key Holder

32003

- Colorful anodized D-ring
- Do not use for climbing
- Comes with a set of 3 key chains



2pc D Ring Key Holder

32004

- Colorful anodized D-ring



3/4" Jaw Mini Clamps

32005

- Tips and handles are rubber coated for easy gripping
- Spring activated metal clamps
- 3/4" jaw opening



Breakaway Knife

32006

- Scored sections of knife allow user to "breakaway" used portions of blade



Single Edge Scraper

32007

- 4.25" Long
- Ideal for scraping labels and decals from glass, windshields, etc



Pocket Tape Measure

32008

- Blade length 3ft
- Blade width 1/4 in



Inspection Mirror

32012

- Extends to 18-1/2"
- 1-1/8" Diameter Mirror
- Handy Pocket Clip



Magnetic Pick Up Tool

32013

- Extends to 18 1/2"
- Handy Pocket Clip



16pc Hex Key Set

32015

- SAE size includes: 1/16, 5/64, 3/32, 1/8, 5/32, 3/16, 7/32, 1/4
- Metric size Includes: 1.5, 2, 2.5, 3, 4, 5, 5.5, & 6mm
- Conveniently stored on key rings
- Different finishes for easy identification: nickel plated for SAE set and black finish for Metric set
- Made of Carbon Steel



6" Adjustable Wrench

32016

- 6" length
- Heavy duty drop forged steel
- Chrome plated to resist corrosion
- Precision machined surfaces



2-in-1 Screwdriver

32014

- Chrome vanadium steel
- Phillips and slotted screwdriver
- Ergonomic soft grip handle for maximum comfort



6-in-1 Screwdriver

32021

- Chrome vanadium bits with magnetic tips
- Ergonomic soft grip handle for maximum comfort
- Contains 4 screwdriver tips: Phillips: #1 & #2 Slotted: 3/16" & 1/4" 2 Nut drivers: 1/4" & 5/16"



Bulk Pliers

- Constructed from durable, long lasting, drop forged heat treated high carbon alloy steel

6" Slip Joint Pliers

32017

Needle Nose Pliers

32018

Diagonal Pliers

32019

Tweezer Pliers

32020

Bulk Screwdrivers

- Ergonomic soft grip handle for maximum comfort
- Chrome vanadium steel shaft
- Magnetic tip

#2 x 4" Phillips Screwdriver

32022

#1 x 3" Phillips Screwdriver

32023

1/4" x 4" Slotted Screwdriver

32024

3/16" x 3" Slotted Screwdriver

32025



Mini All-Purpose Cleaning Brush

32010

- Compact size
- Non-marring finish
- Soft bristles
- For use of cleaning under fingernails and confined spaces



Permanent Markers

32027

- Non toxic
- Fine point
- Quick drying
- Includes (4) markers: (3) black, (1) red



Mini Magnetic Tray

32028

- Size: 8-7/8 x 2-1/2, depth: 1-1/4"
- Perfect for holding small parts, hardware and fasteners in place
- Sticks to any ferrous metal surface - it even works upside down! Rubber covered magnetic base prevents scratching



3/16"x 50ft Polypropylene Rope

32029

- Polypropylene
- 300 lb. Test
- 30 lb. Working Load
- UV Resistant
- Rot Resistant



3pk Nitrile Gloves

32031

- Latex free
- Use for general purpose tasks
- Not recommended for use with chemicals
- One size fits most



TITAN

Professional Tools

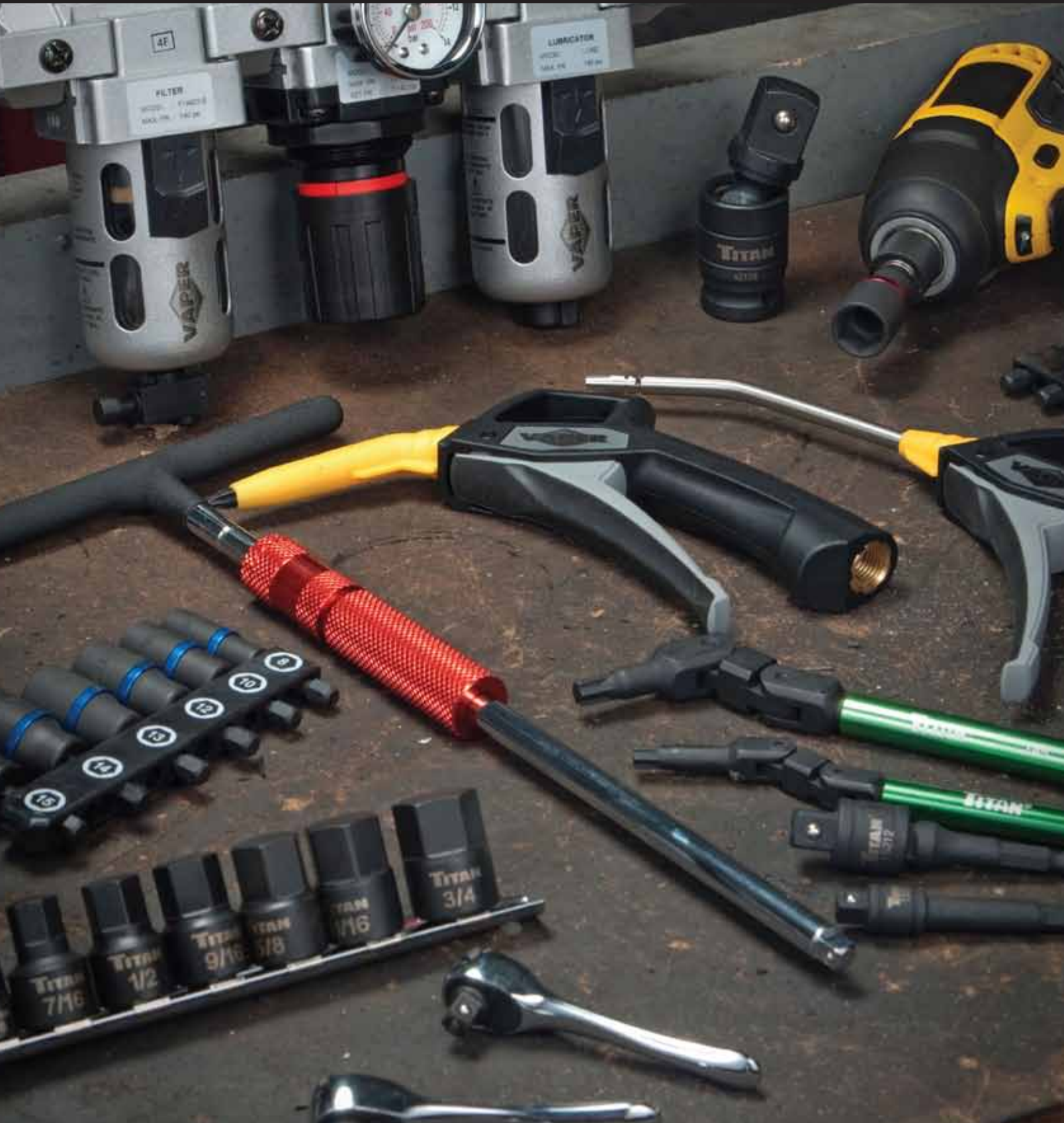

CONTENTS

TITAN PRODUCTS

<i>Mechanic's Tools</i>	4 - 22
<i>Automotive Specialty Tools</i>	23
<i>Hand Tools</i>	24 - 34
<i>General Tools</i>	35 - 43
<i>Tools Boards</i>	44 - 45
<i>NEW TITAN PRODUCTS</i>	46 - 56

VAPER PRODUCTS

<i>Paint, Body and Equipment</i>	58 - 63
<i>Air Tools & Air Tool Accessories</i>	64 - 66
<i>Welding</i>	67 - 69
<i>Power Tools & Power Tool Accessories</i>	70 - 71
<i>NEW VAPER PRODUCTS</i>	72 - 79

SHOP IRON PRODUCTS

<i>Bench Vises</i>	81
<i>Lug Nut Wrenches</i>	82

TEKZ PRODUCTS

<i>Mechanic's Tools</i>	84 - 86
<i>Hand Tools</i>	87
<i>General Tools</i>	88 - 89
<i>General Tools - Service Kits</i>	90 - 96
<i>Welding</i>	97
<i>NEW TEKZ PRODUCTS</i>	98

BOZEMAN PRODUCTS

<i>Hand Tools - Cutting Tools</i>	100-101
---	---------

BULK PRODUCTS

<i>Bulk Tools</i>	102
-------------------------	-----

<i>Item Number Listing</i>	103 - 110
<i>Notes</i>	111



This Section Includes:

MECHANIC'S TOOLS

AUTOMOTIVE SPECIALTY TOOLS

HAND TOOLS

GENERAL TOOLS

TOOL BOARDS

NEW TITAN PRODUCTS

3 pc Quick Release Offset Ratchet Set

- Includes 1/4", 3/8" and 1/2" drive ratchets
- Contoured cushion grip handle
- Offset design for hard-to-reach fasteners
- 72 Tooth gear drive ratchet mechanism engages with 5 degree swing to work in tight areas
- Push button release
- Chrome vanadium steel construction

18025 - HANG TAB

Master: 12 Inner: 3
UPC: 8-02090-18025-5



Quick Release Offset Ratchet

- Contoured cushion grip handle
- Offset design for hard-to-reach fasteners
- 72 Tooth gear drive ratchet mechanism engages with 5 degree swing to work in tight areas
- Push button release
- Chrome vanadium steel construction



1/4" DRIVE RATCHET

12042 - HANG TAB

Master: 100 Inner: 25
UPC: 8-02090-12042-8

3/8" DRIVE RATCHET

12043 - HANG TAB

Master: 48 Inner: 12
UPC: 8-02090-12043-5

1/2" DRIVE RATCHET

12044 - HANG TAB

Master: 24 Inner: 6
UPC: 8-02090-12044-2

Extra-Long Quick Release Offset Ratchet

- Extra-long offset design for hard-to-reach fasteners
- 36-tooth gear-drive ratchet mechanism for high torque applications
- Push button, Quick Release feature
- Contoured cushion grip handle

3/8" DRIVE 9-3/4" RATCHET

12045 - HANG TAB

Master: 24 Inner: 6
UPC: 8-02090-12045-9

1/2" DRIVE 15" RATCHET

12046 - HANG TAB

Master: 24 Inner: 6
UPC: 8-02090-12046-6



COMBINATION Dual-Head Ratchets

- It's like having 2 ratchets in one
- 72 tooth ratchet mechanism engages with just 5 degrees of sweep for work in the tightest spaces
- Contoured cushion grip handle



1/4" & 3/8" DR. RATCHET

11057 - COUNTER DISPLAY

Master: 48 Inner: 12
UPC: 8-02090-11057-3

3/8" & 1/2" DR. RATCHET

11058 - COUNTER DISPLAY

Master: 24 Inner: 6
UPC: 8-02090-11058-0

COMBINATION Dual-Head Offset Ratchets

- 72 tooth ratchet mechanism engages with just 5 degrees of sweep for work in the tightest spaces
- Contoured cushion grip handle



1/4 & 3/8" Dual-Head

12052 - HANG TAB

Master: 24 Inner: 6
UPC: 8-02090-12052-7

3/8 & 1/2" Dual-Head

12053 - HANG TAB

Master: 48 Inner: 6
UPC: 8-02090-12053-4

COMBINATION Dual-Head Flex-Head Ratchets

- It's like having 2 ratchets in one
- 72 tooth ratchet mechanism engages with just 5 degrees of sweep for work in the tightest spaces
- Contoured cushion grip handle
- Injection molded hanger



1/4 & 3/8" Dual-Head

12357 - HANG TAB

Master: 48 Inner: 6
UPC: 8-02090-12357-3

1/4 & 3/8" Dual-Head

11357 - COUNTER DISPLAY

Master: 48 Inner: 12
UPC: 8-02090-11357-4

3/8 & 1/2" Dual-Head

12358 - HANG TAB

Master: 48 Inner: 6
UPC: 8-02090-12358-0

3/8 & 1/2" Dual-Head

11358 - COUNTER DISPLAY

Master: 48 Inner: 12
UPC: 8-02090-11358-1

COMBINATION Dual-Head Stubby Ratchets

- 72 tooth ratchet mechanism engages with 5 degree swing to work in tight areas
- Contoured cushion grip handle



1/4 & 3/8" Dual-Head

11050 - COUNTER DISPLAY

Master: 48 Inner: 6
UPC: 8-02090-11050-4

1/4 & 3/8" Dual-Head

12050 - HANG TAB

Master: 48 Inner: 6
UPC: 8-02090-12050-3

3/8 & 1/2" Dual-Head

11051 - COUNTER DISPLAY

Master: 48 Inner: 12
UPC: 8-02090-11051-1

3/8 & 1/2" Dual-Head

12051 - HANG TAB

Master: 48 Inner: 6
UPC: 8-02090-12051-0

3/8 & 1/2" Dual-Head - LRG.

11054 - COUNTER DISPLAY

Master: 36 Inner: 9
UPC: 8-02090-11054-2

COMBINATION Dual-Head Stubby Flex-Head Ratchets

- 72 tooth ratchet mechanism engages with just 5 degrees of sweep for work in the tightest spaces
- Contoured cushion grip handle



1/4 & 3/8" Dual-Head

12350 - HANG TAB

Master: 48 Inner: 6
UPC: 8-02090-11350-5

3/8 & 1/2" Dual-Head

11351 - COUNTER DISPLAY

Master: 48 Inner: 12
UPC: 8-02090-11351-2

12351 - HANG TAB

Master: 48 Inner: 6
UPC: 8-02090-12351-1

Round Swivel-Head Ratchets

- Unique swivel head design for confined areas
- 72 tooth ratchet mechanism
- Chrome moly steel construction

1/4" DRIVE - 5-1/2"

11066 - HANG TAB

Master: 48 Inner: 6
UPC: 8-02090-11066-5

3/8" DR. MICRO - 5-3/4"

11067 - HANG TAB

Master: 48 Inner: 6
UPC: 8-02090-11067-2

3/8" DRIVE - 8-3/4"

11076 - HANG TAB

Master: 48 Inner: 6
UPC: 8-02090-11076-4



11" Extra-Long Round Swivel-Head Ratchets

- Unique swivel head design for confined areas
- 72 tooth ratchet mechanism
- Chrome moly steel construction

1/4" DRIVE

11068 - CARDED

Master: 48 Inner: 6
UPC: 8-02090-11068-9

3/8" DR. MICRO

11069 - CARDED

Master: 48 Inner: 6
UPC: 8-02090-11069-6



3 pc Extra-Long Round Flex-Head Quick Release Ratchet Set

- Contains 1/4" Dr. x 12", 3/8" Dr. x 18" and 1/2" Dr. x 24" ratchets
- Extra-long flex-head design for hard-to-reach fasteners
- 36-tooth gear-drive ratchet mechanism for high torque applications
- Push button, Quick Release feature
- Contoured cushion grip handles

11075 - BOXED

Master: 48 Inner: 6
UPC: 8-02090-11068-9



Extra-Long Round Flex-Head Quick Release Ratchets

- Set contains 1/4" Dr. x 12", 3/8" Dr. x 18" and 1/2" Dr. x 24" ratchets
- Extra-long flex-head design for hard-to-reach fasteners
- 36-tooth gear-drive ratchet mechanism for high torque applications
- Push button, Quick Release feature - Contoured cushion grip handles

1/4" DR. x 12" 11074 - HANG TAB

Master: 48 Inner: 12 UPC: 8-02090-11074-0

3/8" DR. x 18" 11073 - HANG TAB

Master: 24 Inner: 6 UPC: 8-02090-11073-3

1/2" DR. x 24" 11072 - HANG TAB

Master: 12 Inner: 6 UPC: 8-02090-11072-6



Repair Kits

- For Extra-Long, Flex-Head Quick Release Ratchets
- Includes: FWD/REV Switch, Pawl Springs, Pawls (Left & Right), Switch Screw, Thrust Plate Screws, Thrust Washer, Thrust Plate, Drive Gear Assembly

11084 - for 11074

UPC: 8-02090-11084-9

11083 - for 11073

UPC: 8-02090-11083-2

11082 - for 11072

UPC: 8-02090-11082-5

Extra-Long Round Quick Release Ratchets

- Set contains 1/2", 3/8", & 1/4" Drive
- 36 fine-tooth ratchet design for fast performance
- Less than 5 degree sweep for use in tight spots
- Extra-Long design for increased torque
- Push button quick release design
- Chrome vanadium steel

3 pc SET -

1/4", 3/8" & 1/2" DR.

11088 - BOXED

Master: 8 Inner: 4
UPC: 8-02090-11088-7

1/4" DR. x 12"

11085 - HANG TAB

Master: 48 Inner: 12
UPC: 8-02090-11085-6

3/8" DR. x 18"

11086 - HANG TAB

Master: 24 Inner: 6
UPC: 8-02090-11086-3

1/2" DR. x 24"

11087 - HANG TAB

Master: 12 Inner: 6
UPC: 8-02090-11087-0



Extendable Quick Release Ratchets

- Telescopes in 5 increments
- Push button, Quick Release ratchet head
- Contoured cushion grip handle - Knurled handle for better grip (12072)
- Chrome vanadium steel

3/8" DR. - 8-1/2" to 12-1/2"

12070 - HANG TAB

Master: 48 Inner: 6
UPC: 8-02090-12070-1

1/2" DR. - 12" to 17-1/2"

12074 - HANG TAB

Master: 12 Inner: 6
UPC: 8-02090-12074-9

1/2" DR. X-Long - 18" to 24"

12073 - HANG TAB

Master: 12 Inner: 6
UPC: 8-02090-12073-2

1/4" DR. - 6" to 7-7/8"

12075 - HANG TAB

Master: 48 Inner: 6
UPC: 8-02090-12075-6



3/4" DR. - 19-1/2" to 30-5/16"

12072 - HANG TAB

Master: 4 Inner: 1
UPC: 8-02090-12072-5



12072

Mini Ratchets

- Compact handle for confined areas - Knurled handle for better grip - Chrome vanadium steel

1/4" DR. w/ Bit Driver - 3-1/2"

12101 - HANG TAB

Master: 96 Inner: 6
UPC: 8-02090-12101-2

1/4 & 3/8" DUAL HEAD - 4-1/8"

12103 - HANG TAB

Master: 48 Inner: 6
UPC: 8-02090-12103-6

3/8" DR. Quick Release - 4-1/8"

12102 - HANG TAB

Master: 96 Inner: 6
UPC: 8-02090-12102-9



1/4" Dr. Ratchet & Bit Driver

- 4-1/8" Length
- Compact handle for confined areas
- Contoured cushion grip handle
- Includes bit driver feature
- Chrome vanadium steel

12041 - HANG TAB

Master: 96 Inner: 6
UPC: 8-02090-12041-1



Finger Ratchets

- Contoured grip for comfort and power
- Reversible ratchet mechanism
- Designed to reach confined spaces

1/4" DRIVE

12090 - HANG TAB

Master: 96 Inner: 12
UPC: 8-02090-12090-9

1/2" DRIVE

12092 - HANG TAB

Master: 96 Inner: 12
UPC: 8-02090-12092-3

3/8" DRIVE

12091 - HANG TAB

Master: 96 Inner: 12
UPC: 8-02090-12091-6

2 pc FINGER RATCHETS, 1/4" & 3/8"

12093 - CARDED

Master: 96 Inner: 12
UPC: 8-02090-12093-0



Gearless Micro Ratchets

- Gearless ratchet design for smooth operation and less than 3 degree sweep make these ratchets ideal for confined areas
- Chrome-Molybdenum Steel

1/4" DR.

11200 - COUNTER DISPLAY

Master: 36 Inner: 6
UPC: 8-02090-11200-3

3/8" DR.

11201 - COUNTER DISPLAY

Master: 36 Inner: 6
UPC: 8-02090-11201-0

2 pc 1/4" Dr. & 3/8" Dr.

18202 - CARDED

Master: 48 Inner: 6
UPC: 8-02090-18202-0



Reversible Torque Wrenches

- Reversible torque design with push-through drive square for both right & left hand threads
- Easy to read analog scale window - Chrome vanadium ratchet gear
- Fully heat-treated handle with non-slip grip - Meets ANSI specifications
- Ships in protective blow molded storage case

3/8" Dr. 20 - 80 ft. lbs.
23149 - HANG TAB
 Master: 12 Inner: 4
 UPC: 8-02090-23149-0

1/2" Dr. 50 - 250 ft. lbs.
23151 - HANG TAB
 Master: 8 Inner: 4
 UPC: 8-02090-23151-3

1/2" Dr. 20 - 150 ft. lbs.
23150 - HANG TAB
 Master: 10 Inner: 5
 UPC: 8-02090-23150-6



Indexing Ratchets

- Gearless ratchet design for smooth operation and less than 3 degree sweep make these ratchets ideal for confined areas
- Packed in re-usable storage tray - U.S. Patent
- Chrome-Molybdenum Steel

1/4" DR.
12095 - HANG TAB
 Master: 48 Inner: 6
 UPC: 8-02090-12095-4

1/2" DR.
12097 - HANG TAB
 Master: 24 Inner: 6
 UPC: 8-02090-12097-8

3/8" DR.
12096 - HANG TAB
 Master: 24 Inner: 6
 UPC: 8-02090-12096-1

3 pc 1/4, 3/8 & 1/2" Dr.
12094 - BOXED
 Master: 12 Inner: 1
 UPC: 8-02090-12094-7



Ratcheting Breaker Bars

- Heavy duty chrome vanadium steel construction
- 3-way ratcheting action: right-hand thread, left-hand thread or lock
- Chrome plated bar and black oxide finish on head to resist corrosion

3/8" DR. x 15"
12015 - HANG TAB
 Master: 12 Inner: 3
 UPC: 8-02090-12015-2

1/2" DR. x 18"
12018 - HANG TAB
 Master: 12 Inner: 3
 UPC: 8-02090-12018-3

1/2" DR. x 24"
12024 - HANG TAB
 Master: 12 Inner: 3
 UPC: 8-02090-12024-4

Ratcheting Breaker Bar Replacement Head

- For 12015 ratcheting breaker bar

12027 - BULK

Ratcheting Breaker Bar Replacement Head

- For 1/2" Dr. ratcheting breaker bar

12021 - BULK

Ratcheting Breaker Bar Replacement Head

- For 12018 & 12024 ratcheting breaker bars

12028 - BULK

Ratcheting Breaker Bar Replacement Head

- For 3/4" Dr. ratcheting breaker bars

12022 - BULK

Ratcheting Breaker Bar Replacement Head

- For 1" Dr. ratcheting breaker bars

12023 - BULK

Breaker Bars

- Chrome plated bar and black oxide finish on head to resist corrosion
- Heavy duty chrome vanadium steel construction

3/8" DR. x 18"
12019 - HANG TAB
 Master: 24 Inner: 6
 UPC: 8-02090-12019-0

1/2" DR. x 30"
12047 - HANG TAB
 Master: 12 Inner: 6
 UPC: 8-02090-12047-3

3/4" DR. x 40"
12048 - HANG TAB
 Master: 6 Inner: 3
 UPC: 8-02090-12048-0

1" DR. x 40"
12049 - HANG TAB
 Master: 4 Inner: 2
 UPC: 8-02090-12049-7



SAE Ratcheting Wrenches

- 72 fine-tooth ratchet design for fast performance
 - Less than 5 degree sweep for use in tight spots - Chrome vanadium steel

1/4"	12601*	UPC: 8-02090-12601-7
5/16"	12602*	UPC: 8-02090-12602-4
3/8"	12603*	UPC: 8-02090-12603-1
7/16"	12604*	UPC: 8-02090-12604-8
1/2"	12605*	UPC: 8-02090-12605-5
9/16"	12606*	UPC: 8-02090-12606-2
5/8"	12607**	UPC: 8-02090-12607-9
11/16"	12608*	UPC: 8-02090-12608-6
3/4"	12609*	UPC: 8-02090-12609-3
13/16"	12610*	UPC: 8-02090-12610-9
7/8"	12611**	UPC: 8-02090-12611-6
15/16"	12612**	UPC: 8-02090-12612-3
1"	12613**	UPC: 8-02090-12613-0
1-1/16"	12614***	UPC: 8-02090-12614-7
1-1/8"	12615***	UPC: 8-02090-12615-4
1-1/4"	12616***	UPC: 8-02090-12616-1
HANG TAB		*Master: 100 Inner: 10 **Master: 50 Inner: 10 ***Master: 20 Inner: 10



METRIC Ratcheting Wrenches

- 72 fine-tooth ratchet design for fast performance
 - Less than 5 degree sweep for use in tight spots
 - Chrome vanadium steel

6mm	12506	UPC: 8-02090-12506-5
7mm	12507	UPC: 8-02090-12507-2
8mm	12508	UPC: 8-02090-12508-9
9mm	12509	UPC: 8-02090-12509-6
10mm	12510	UPC: 8-02090-12510-2
11mm	12511	UPC: 8-02090-12511-9
12mm	12512	UPC: 8-02090-12512-6
13mm	12513	UPC: 8-02090-12513-3
14mm	12514	UPC: 8-02090-12514-0
15mm	12515	UPC: 8-02090-12515-7
16mm	12516	UPC: 8-02090-12516-4
17mm	12517	UPC: 8-02090-12517-1
18mm	12518	UPC: 8-02090-12518-8
19mm	12519	UPC: 8-02090-12519-5
20mm	12520	UPC: 8-02090-12520-1
21mm	12521	UPC: 8-02090-12521-8
22mm	12522	UPC: 8-02090-12522-5
24mm	12524	UPC: 8-02090-12524-9
25mm	12525	UPC: 8-02090-12525-6
27mm	12526	UPC: 8-02090-12526-3
30mm	12527	UPC: 8-02090-12527-0
32mm	12528	UPC: 8-02090-12528-7
34mm	12529	UPC: 8-02090-12529-4
HANG TAB		Master: 100 Inner: 10



7 pc Ratcheting Combination Wrench Sets

- 72 fine-tooth ratchet design for fast performance
 - Less than 5 degree sweep for use in tight spots
 - Chrome vanadium steel - Reusable storage rack

SAE Set sizes: 5/16, 3/8, 7/16, 1/2, 9/16, 5/8 & 3/4"

17350 - HANG TAB
 Master: 20 Inner: 5
 UPC: 8-02090-17350-9

METRIC Set sizes:
 8, 10, 12, 13, 15, 16 & 18mm
17351 - HANG TAB
 Master: 20 Inner: 5
 UPC: 8-02090-17351-6



Ratcheting Combination Wrench Sets

- 72 fine-tooth ratchet design for fast performance
 - Less than 5 degree sweep for use in tight spots
 - Chrome vanadium steel - Reusable storage rack

13 pc SAE Set sizes:

1/4, 5/16, 3/8, 7/16, 1/2, 9/16, 5/8, 11/16, 3/4, 13/16, 7/8, 15/16 & 1"

17354 - HANG TAB
 Master: 6 Inner: 1
 UPC: 8-02090-17354-7

12 pc METRIC Set sizes:

8, 9, 10, 11, 12, 13, 14, 15, 16, 17, 18 and 19mm

17355 - HANG TAB
 Master: 6 Inner: 1
 UPC: 8-02090-17355-4



5 pc Ratcheting Combination Wrench Sets

- 72 tooth ratchet design with 5° sweep for confined areas
 - Meets ANSI specifications
 - Chrome vanadium steel construction

SAE Set sizes: 3/8, 7/16, 1/2, 9/16, & 5/8"

17352 - CARDED
 Master: 24 Inner: 6
 UPC: 8-02090-17352-3

METRIC Set sizes: 10, 12, 13, 14, & 15mm

17353 - CARDED
 Master: 24 Inner: 6
 UPC: 8-02090-17353-0



SAE Reversible Ratcheting Wrenches

- 72 tooth ratchet design with 5 degree sweep for use in confined areas
- Chrome Vanadium steel construction
- 15 degree offset design - Meets ANSI specifications

1/4"	14601*	UPC: 8-02090-14601-5
5/16"	14602*	UPC: 8-02090-14602-2
3/8"	14603*	UPC: 8-02090-14603-9
7/16"	14604*	UPC: 8-02090-14604-6
1/2"	14605*	UPC: 8-02090-14605-3
9/16"	14606*	UPC: 8-02090-14606-0
5/8"	14607*	UPC: 8-02090-14607-7
11/16"	14608*	UPC: 8-02090-14608-4
3/4"	14609*	UPC: 8-02090-14609-1
13/16"	14610**	UPC: 8-02090-14610-7
7/8"	14611**	UPC: 8-02090-14611-4
15/16"	14612**	UPC: 8-02090-14612-1
1"	14613**	UPC: 8-02090-14613-8
HANG TAB		*Master: 50 Inner: 10 **Master: 25 Inner: 5



METRIC Reversible Ratcheting Wrenches

- 72 tooth ratchet design with 5 degree sweep for use in confined areas
- Chrome Vanadium steel construction
- 15 degree offset design
- Meets ANSI specifications

8mm	14508	UPC: 8-02090-14508-7
9mm	14509	UPC: 8-02090-14509-4
10mm	14510	UPC: 8-02090-14510-0
11mm	14511	UPC: 8-02090-14511-7
12mm	14512	UPC: 8-02090-14512-4
13mm	14513	UPC: 8-02090-14513-1
14mm	14514	UPC: 8-02090-14514-8
15mm	14515	UPC: 8-02090-14515-5
16mm	14516	UPC: 8-02090-14516-2
17mm	14517	UPC: 8-02090-14517-9
18mm	14518	UPC: 8-02090-14518-6
19mm	14519	UPC: 8-02090-14519-3
HANG TAB		Master: 50 Inner: 10



Reversible Ratcheting Wrench Sets

- 72 tooth ratchet design with 5 degree sweep
- Chrome Vanadium steel construction - 15 degree offset design
- Meets ANSI specifications - Re-usable storage rack

13 pc SAE Set sizes: 1/4, 5/16, 3/8, 7/16, 1/2, 9/16, 5/8, 11/16, 3/4, 13/16, 7/8, 15/16 & 1"

17364 - HANG TAB

Master: 6 Inner: 1
UPC: 8-02090-17364-6

12 pc METRIC Set sizes: 8, 9, 10, 11, 12, 13, 14, 15, 16, 17, 18 & 19mm

17365 - HANG TAB

Master: 6 Inner: 1
UPC: 8-02090-17365-3



SAE Ratcheting Flex Wrenches

- Flex-head design to reach confined areas
- 72 fine-tooth ratchet design for fast performance
- Less than 5 degree sweep for use in tight spots
- Chrome vanadium steel

1/4"	12901*	UPC: 8-02090-12901-8
5/16"	12902*	UPC: 8-02090-12902-5
3/8"	12903**	UPC: 8-02090-12903-2
7/16"	12904**	UPC: 8-02090-12904-9
1/2"	12905**	UPC: 8-02090-12905-6
9/16"	12906**	UPC: 8-02090-12906-3
5/8"	12907**	UPC: 8-02090-12907-0
11/16"	12908**	UPC: 8-02090-12908-7
3/4"	12909**	UPC: 8-02090-12909-4
13/16"	12910***	UPC: 8-02090-12910-0
7/8"	12911***	UPC: 8-02090-12911-7
HANG TAB		*Master: 50 Inner: 10 **Master: 100 Inner: 30 ***Master: 50 Inner: 30



METRIC Ratcheting Flex Wrenches

- Flex-head design to reach confined areas
- 72 fine-tooth ratchet design for fast performance
- Less than 5 degree sweep for use in tight spots
- Chrome vanadium steel

8mm	12808*	UPC: 8-02090-12808-0
9mm	12809*	UPC: 8-02090-12809-7
10mm	12810**	UPC: 8-02090-12810-3
11mm	12811**	UPC: 8-02090-12811-0
12mm	12812**	UPC: 8-02090-12812-7
13mm	12813**	UPC: 8-02090-12813-4
14mm	12814**	UPC: 8-02090-12814-1
15mm	12815**	UPC: 8-02090-12815-8
16mm	12816**	UPC: 8-02090-12816-5
17mm	12817**	UPC: 8-02090-12817-2
18mm	12818**	UPC: 8-02090-12818-9
19mm	12819**	UPC: 8-02090-12819-6
HANG TAB		*Master: 50 Inner: 10 **Master: 100 Inner: 30



7 pc Ratcheting Flex Wrench Sets

- 72 fine-tooth ratchet design for fast performance
- Less than 5 degree sweep for use in tight spots
- Chrome vanadium steel - Reusable storage rack

SAE Set sizes: 7/16, 1/2, 9/16, 5/8, & 3/4"

17360 - HANG TAB

Master: 12 Inner: 6
UPC: 8-02090-17360-8

METRIC Set sizes:

8, 10, 12, 13, 15, 16, & 18mm

17361 - HANG TAB

Master: 12 Inner: 6
UPC: 8-02090-17361-5



Ratcheting Flex-Head Wrench Sets

- 72 fine-tooth ratchet design for fast performance
- Less than 5 degree sweep for use in tight spots
- Chrome vanadium steel - Reusable storage rack

13 pc SAE Set sizes: 1/4, 5/16, 3/8, 7/16, 1/2, 9/16, 5/8, 11/16, 3/4, 13/16, 7/8, 15/16 & 1"

17366 - HANG TAB

Master: 6 Inner: 1
UPC: 8-02090-17366-0

12 pc METRIC Set sizes: 8, 9, 10, 11, 12, 13, 14, 15, 16, 17, 18 & 19mm

17367 - HANG TAB

Master: 6 Inner: 1
UPC: 8-02090-17367-7



METRIC & SAE Double Box Wrenches

- Fully polished and chrome plated CR-V steel

8 x 9mm **13520** UPC: 8-02090-13520-0

10 x 11mm **13521** UPC: 8-02090-13521-7

12 x 13mm **13522** UPC: 8-02090-13522-4

14 x 15mm **13523** UPC: 8-02090-13523-1

16 x 18mm **13524** UPC: 8-02090-13524-8

17 x 19mm **13525** UPC: 8-02090-13525-5

5/16 x 3/8" **13526** UPC: 8-02090-13526-2

7/16 x 1/2" **13527** UPC: 8-02090-13527-9

9/16 x 5/8" **13528** UPC: 8-02090-13528-6

11/16 x 3/4" **13529** UPC: 8-02090-13529-3

HANG TAB Master: 100 Inner: 10



11 pc Combination Full Polish Wrench Sets

- Fully polished and chrome plated CR-V steel
- Reusable storage rack

SAE Set sizes: 1/4, 5/16, 3/8, 7/16, 1/2, 9/16, 5/8, 11/16, 3/4, 13/16, 7/8"

17311 - HANG TAB

Master: 12 Inner: 6
UPC: 8-02090-17311-0

METRIC Set sizes: 8, 9, 10, 11, 12, 13, 14, 15, 16, 17 & 18mm

17312 - HANG TAB

Master: 12 Inner: 6
UPC: 8-02090-17312-7



18 pc Extra-Long Wrench Set

- Extended / Extra-Long wrenches:
- 1/4, 5/16, 3/8, 7/16, 1/2, 9/16, 5/8, 3/4, 7/8" and 10, 11, 12, 13, 14, 15, 16, 17, 18 mm
- Chrome vanadium steel
- Reusable storage racks

17396 - HANG TAB

Master: 6 Inner: 1
UPC: 8-02090-17396-7



22 pc Standard & Metric Combination Wrench Set

- Contains: 1/4, 5/16, 3/8, 7/16, 1/2, 9/16, 5/8, 11/16, 3/4, 13/16, 7/8" and 9, 10, 11, 12, 13, 14, 15, 16, 17, 18 & 19mm wrenches
- Chrome vanadium steel
- Reusable storage rack

17398 - HANG TAB

Master: 8 Inner: 2
UPC: 8-02090-17398-1



11 pc Combination Raised Panel Wrench Sets

- Chrome vanadium steel - Reusable storage rack

SAE Set sizes: 1/4, 5/16, 3/8, 7/16, 1/2, 9/16, 5/8, 11/16, 3/4, 13/16, 7/8"

17327 - HANG TAB

Master: 12 Inner: 6
UPC: 8-02090-17327-1



METRIC Set sizes: 8, 9, 10, 11, 12, 13, 14, 15, 16, 17 & 18mm

17328 - HANG TAB

Master: 12 Inner: 6
UPC: 8-02090-17328-8

7/16" Coaxial Nut Combination Wrench

- Packaged on Injection Hanger
- Chrome Vanadium Construction
- Fully polished
- Allows for rapid removal or installation of 7/16" hex fasteners
- 15 degree offset box end
- Excellent for use with 7/16" coaxial nuts

14614 - HANG TAB

Master: 48 Inner: 6
UPC: 8-02090-14614-5



Combination Raised Panel Wrench Sets

- Nylon storage pouch
- Raised panel design
- CRV Constructed

14 pc SAE Set sizes:

3/8, 7/16, 1/2, 9/16, 5/8, 11/16, 3/4, 13/16, 7/8, 15/16, 1, 1-1/16, 1-1/8, 1-1/4"

17329 - POUCH

Master: 4 Inner: 1
UPC: 8-02090-17329-5

16 pc METRIC Set sizes:

10, 11, 12, 13, 14, 15, 16, 17, 18, 19, 21, 22, 24, 25, 30, 32mm

17330 - POUCH

Master: 4 Inner: 1
UPC: 8-02090-17330-1

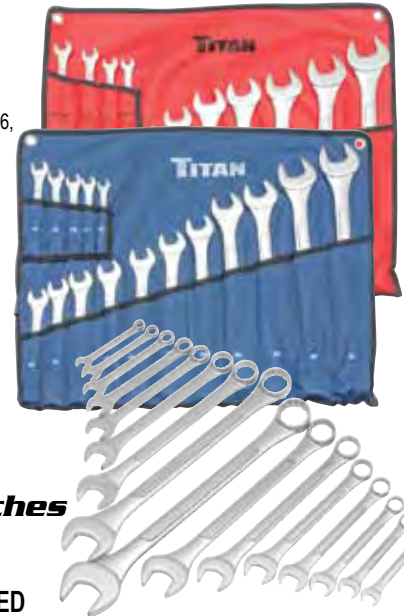

Wrench Set Pouches

- Nylon storage pouches for SAE or Metric wrenches (not included)

14 POCKET SAE POUCH - RED

98050 - BULK

Master: _ Inner: _
UPC: 8-02090-98050-3

16 POCKET MM POUCH - BLUE

98051 - BULK

Master: _ Inner: _
UPC: 8-02090-98051-0



Wrench Organizer

- Easy organization for loose wrenches
- Holds up to 14 wrenches, 1/4" (6mm) and larger
- Wall mount hardware included: Wood Screws, Nuts, Bolts and Washers & Rivets

98017 - CARDED

Master: 48 Inner: 6
UPC: 8-02090-98017-6



8" Stubby Adjustable Wrench

- Up to 1" jaw capacity with laser etched scale in inches on one side and millimeters on the other
- Contoured cushion grip handle

11060 - COUNTER DISPLAY

Master: 48 Inner: 6
UPC: 8-02090-11060-3

12060 - CARDED

Master: 48 Inner: 6
UPC: 8-02090-12060-2



Easy Carry Wrench Racks

- Sturdy plastic grippers are slightly flexible, gripping wrenches firmly, yet allowing easy placement or removal
- Large carry handle
- Engraved with sizes markings

12 Slot, Metric: 8mm through 19mm

98012 - HANG TAB

Master: 50 Inner: 1
UPC: 8-02090-98012-1

13 Slot SAE: 1/4" through 1"

98013 - HANG TAB

Master: 50 Inner: 1
UPC: 8-02090-98013-8

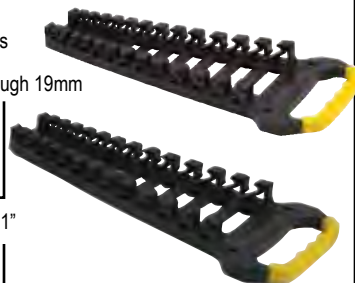

8" Flex-Head Adjustable Wrench

- Twisted handle puts the flat side against palm, giving up to 1-1/8" of contact for more comfort and leverage
- Ordinary wrenches only give 3/8" of palm contact creating increased user fatigue and less turning power
- Flexible swivel head gets into hard to reach areas
- Tough chrome molybdenum steel construction
- Inch scale engraved on one side - metric scale engraved on the other

11071 - CARDED

Master: 36 Inner: 6
UPC: 8-02090-11071-9



24v Cordless Impact Wrench

- Delivers 280 lb/ft of maximum torque
- 1/2" DR anvil is heat treated for strength and durability
- Heavy duty alloy gear case - Durable all-metal transmission
- 1-Hour quick charger - One battery included

22160 - BOXED

Master: 3 Inner: 1
UPC: 8-02090-22160-6

24V RECHARGEABLE NI-CD BATTERY PACK

- 24V Rechargeable Nickel Cadmium Battery
- 1.7 Amp hours

22162 - BOXED

Master: 20 Inner: 1
UPC: 8-02090-22162-0



Battery Pack for 22160 Impact Wrench



3,000 lb. Scissor Jack

- Lift Range: 4 - 15"
- Spinning handle grips & ball bearing worm gear for easy rotation
- Oversize, steel saddle to secure and stabilize load
- Sturdy oversize base for support & stability
- Meets or exceed ANSI standards

21010 - DISPLAY BOX

Master: 10 Inner: 1
UPC: 8-02090-21010-5



Folding Hex Key Sets

- High quality alloy steel with black oxide finish
- SAE Sizes: - 0.05, 1/16, 5/64, 3/32, 7/64, 1/8, 9/64, 5/32 & 3/16"
- MM Sizes: - 1.5, 2, 2.5, 3, 4, 5 & 6mm

9pc SAE Folding Hex Key Set

12703 - CARDED

Master: 48 Inner: 6
UPC: 8-02090-12703-8



7pc MM Folding Hex Key Set

12708 - CARDED

Master: 48 Inner: 6
UPC: 8-02090-12708-3

Folding Key Set Counter Display

- Keys fold compact for easy storage
- Corrosion resistant aluminum holders
- Ball Ends allow use at up to 30° angle for use in obstructed areas
- Drilled tips allow use on tamper resistant security screws
- Contains 3 of each of the following key sets:
 - SAE Ball End Hex Key Set (Red - 12700)
 - Metric Ball End Hex Key Set (Blue - 12705)
 - Tamper Resistant Star Key Set (Green - 12710)
- Chrome vanadium steel construction



39 pc Long Arm Hex & Star Key Set

- Long arm design for hard to reach fasteners
- 12 SAE hex keys - 1/16, 5/64, 3/32, 7/64, 1/8, 9/64, 5/32, 3/16, 7/32, 1/4, 5/16, 3/8"
- 13 Metric hex keys- 1.27, 1.5, 2, 2.5, 3, 4, 4.5, 5, 5.5, 6, 7, 8 and 10mm
- 14 Star keys - T6, T7, T8, T9, T10, T15, T20, T25, T27, T30, T40, T45, T50, T55
- Unique 3-way folding storage holder

12739 - CARDED

Master: 15 Inner: 5
UPC: 8-02090-12739-7



Folding Color-Coded Key Sets

SAE Ball End Hex Key Set (Red)

Sizes: 1/16, 5/64, 3/32, 7/64, 1/8, 9/64, 5/32, 3/16, 7/32 & 1/4"

12700 - CARDED

Master: 48 Inner: 6 UPC: 8-02090-12700-7

Metric Ball End Hex Key Set (Blue)

Sizes: 1.5, 2, 2.5, 3, 4, 5, 6 mm Hex keys
and #2 Phillips & 1/4" Slotted screwdrivers

12705 - CARDED

Master: 48 Inner: 6 UPC: 8-02090-12705-2

Tamper Resistant Star Key Set (Green)

Sizes: T-6 thru T-10, T-15, T-20, T-25, T-27 & T-30

12710 - CARDED

Master: 48 Inner: 6 UPC: 8-02090-12710-6

7 pc SAE Hex Key Set

- Sizes: 5/64, 3/32, 7/64, 1/8, 9/64, 5/32 & 3/16"
- High quality alloy steel with black oxide finish
- Convenient marked plastic storage container

12727 - CARDED

Master: 48 Inner: 12
UPC: 8-02090-12727-4



9 pc Metric Hex Key Set

- Sizes: 1.5, 2, 2.5, 3, 4, 5, 6, 8 & 10mm
- High quality alloy steel with black oxide finish
- Convenient marked plastic storage container

12729 - CARDED

Master: 48 Inner: 12
UPC: 8-02090-12729-8



25 pc Hex Key Set

- Includes SAE and Metric sizes:
 - 1/16, 5/64, 3/32, 7/64, 1/8, 9/64, 5/32, 3/16, 7/32, 1/4, 5/16 & 3/8" and 1.27, 1.5, 2, 2.5, 3, 4, 4.5, 5, 5.5, 6, 7, 8 & 10 mm
- Heat treated carbon steel with black oxide finish
- Ships in reusable storage holder
- Pivot style release feature allows removal of any key without moving adjacent keys out of the way

12712 - CARDED

Master: 24 Inner: 6
UPC: 8-02090-12712-0



Extra-Long Arm Hex and Star Key Sets

- Extra-Long design for max torque
- Patent pending textured finish for better grip
- Color coded for easy identification
- Easy to read laser etched sizes
- SAE Ball End sizes: 0.05, 1/16, 5/64, 3/32, 7/64, 1/8, 9/64, 5/32, 3/16, 7/32, 1/4, 5/16 and 3/8"
- Metric Ball End sizes: 1.5, 2, 2.5, 3, 4, 5, 6, 8 and 10mm
- Star sizes: T6 through T10, T15, T20, T25, T27, T30, T40, T45 and T50

13 pc SAE BALL END SET

12713 - CARDED

Master: 36 Inner: 6
UPC: 8-02090-12713-7

9 pc METRIC BALL END SET

12714 - CARDED

Master: 36 Inner: 6
UPC: 8-02090-12714-4

13 pc TAMPER RESISTANT STAR SET

12715 - CARDED

Master: 36 Inner: 6
UPC: 8-02090-12715-1



13 pc SAE Long Arm Hex Key Set

- Sizes: 0.05, 1/16, 5/64, 3/32, 7/64, 1/8, 9/64, 5/32, 3/16, 7/32, 1/4, 5/16 & 3/8"
- High quality alloy steel with black oxide finish
- Convenient marked plastic storage container

12718 - CARDED

Master: 36 Inner: 6
UPC: 8-02090-12718-2



9 pc Metric Long Arm Hex Key Set

- Sizes: 1.5, 2, 2.5, 3, 4, 5, 6, 8 & 10mm
- High quality alloy steel with black oxide finish
- Convenient marked plastic storage container

12719 - CARDED

Master: 36 Inner: 6
UPC: 8-02090-12719-9



3 pc Long Arm Hex and Star Key Sets

- Contains the following key sets:
SAE Hex Key Set (Red-12718)
Metric Hex Key Set (Blue-12719)
Star Key Set (Green-12723)
- Color coded holders

12720 - CARDED

Master: 36 Inner: 6
UPC: 8-02090-12720-2



13 pc Long Arm Star Key Set

- Contains T7, T8, T9, T10, T15, T20, T25, T27, T30, T40, T45, T50 and T55 keys
- Extra-long design for maximum torque
- Convenient folding holder keeps keys organized

12723 - CARDED

Master: 36 Inner: 6
UPC: 8-02090-12723-6



13 pc SAE Ball End Hex Key Set

- Sizes: 0.05, 1/16, 5/64, 3/32, 7/64, 1/8, 9/64, 5/32, 3/16, 7/32, 1/4, 5/16 and 3/8"
- Extra-long design for maximum torque
- Convenient folding holder keeps keys organized

12721 - CARDED

Master: 36 Inner: 6
UPC: 8-02090-12721-2



9 pc Metric Ball End Hex Key Set

- Sizes: 1.5, 2, 2.5, 3, 4, 5, 6, 8 and 10mm
- Extra-long design for maximum torque
- Convenient folding holder keeps keys organized

12722 - CARDED

Master: 36 Inner: 6
UPC: 8-02090-12722-9



SAE Hex Bit Sockets

- Chrome vanadium sockets with S-2 Alloy bits

1/4" Dr. 5/64"	15650	UPC: 8-02090-15650-2
1/4" Dr. 3/32"	15651	UPC: 8-02090-15651-9
1/4" Dr. 7/64"	15652	UPC: 8-02090-15652-6
1/4" Dr. 1/8"	15653	UPC: 8-02090-15653-3
1/4" Dr. 9/64"	15654	UPC: 8-02090-15654-0
1/4" Dr. 5/32"	15655	UPC: 8-02090-15655-7
3/8" Dr. 3/16"	15656	UPC: 8-02090-15656-4
3/8" Dr. 7/32"	15657	UPC: 8-02090-15657-1
3/8" Dr. 1/4"	15658	UPC: 8-02090-15658-8
3/8" Dr. 5/16"	15659	UPC: 8-02090-15659-5
3/8" Dr. 3/8"	15660	UPC: 8-02090-15660-1
HANG TAB	Master: 96 Inner: 6	

1/2" Dr. 7/16"	15661	UPC: 8-02090-15661-8
1/2" Dr. 1/2"	15662	UPC: 8-02090-15662-5
1/2" Dr. 9/16"	15663	UPC: 8-02090-15663-2
1/2" Dr. 5/8"	15664	UPC: 8-02090-15664-9
1/2" Dr. 11/16"	15665	UPC: 8-02090-15665-6
1/2" Dr. 3/4"	15666	UPC: 8-02090-15666-3
1/2" Dr. 13/16"	15667	UPC: 8-02090-15667-0
1/2" Dr. 7/8"	15668	UPC: 8-02090-15668-7
1/2" Dr. 15/16"	15669	UPC: 8-02090-15669-4
1/2" Dr. 1"	15670	UPC: 8-02090-15670-0
HANG TAB	Master: 48 Inner: 6	



Metric Hex Bit Sockets

- Chrome vanadium sockets with S-2 Alloy bits

1/4" Dr. 2.5mm	15600	UPC: 8-02090-15600-7
1/4" Dr. 5.5mm	15601	UPC: 8-02090-15601-4
1/4" Dr. 2mm	15602	UPC: 8-02090-15602-1
1/4" Dr. 3mm	15603	UPC: 8-02090-15603-8
1/4" Dr. 4mm	15604	UPC: 8-02090-15604-5
1/4" Dr. 5mm	15605	UPC: 8-02090-15605-2
3/8" Dr. 6mm	15606	UPC: 8-02090-15606-9
3/8" Dr. 7mm	15607	UPC: 8-02090-15607-6
3/8" Dr. 8mm	15608	UPC: 8-02090-15608-3
3/8" Dr. 9mm	15609	UPC: 8-02090-15609-0
3/8" Dr. 10mm	15610	UPC: 8-02090-15610-6
HANG TAB	Master: 96 Inner: 6	

1/2" Dr. 11mm	15611	UPC: 8-02090-15611-3
1/2" Dr. 12mm	15612	UPC: 8-02090-15612-0
1/2" Dr. 13mm	15613	UPC: 8-02090-15613-7
1/2" Dr. 14mm	15614	UPC: 8-02090-15614-4
1/2" Dr. 15mm	15615	UPC: 8-02090-15615-1
1/2" Dr. 16mm	15616	UPC: 8-02090-15616-8
1/2" Dr. 17mm	15617	UPC: 8-02090-15617-5
1/2" Dr. 18mm	15618	UPC: 8-02090-15618-2
1/2" Dr. 19mm	15619	UPC: 8-02090-15619-9
1/2" Dr. 20mm	15620	UPC: 8-02090-15620-5
1/2" Dr. 21mm	15621	UPC: 8-02090-15621-2
1/2" Dr. 22mm	15622	UPC: 8-02090-15622-9
HANG TAB	Master: 48 Inner: 6	



1/2" Dr.

Star Bit Sockets

- Chrome vanadium sockets with S-2 Alloy bits

1/2" Dr. T-60	15560	UPC: 8-02090-15560-4
1/2" Dr. T-70	15570	UPC: 8-02090-15570-3
HANG TAB	Master: 96 Inner: 12	



1/4" Dr.

Tamper Resistant Star Bit Sockets

- Chrome vanadium sockets with S-2 Alloy bits

1/4" Dr. T-10	15410	UPC: 8-02090-15410-2
1/4" Dr. T-15	15415	UPC: 8-02090-15415-7
1/4" Dr. T-20	15420	UPC: 8-02090-15420-1
1/4" Dr. T-25	15425	UPC: 8-02090-15425-6
1/4" Dr. T-27	15427	UPC: 8-02090-15427-0
1/4" Dr. T-30	15430	UPC: 8-02090-15430-0
HANG TAB	Master: 96 Inner: 12	



3/8" Dr.

Tamper Resistant Star Bit Sockets

- Chrome vanadium sockets with S-2 Alloy bits

3/8" Dr. T-40	15440	UPC: 8-02090-15440-9
3/8" Dr. T-45	15445	UPC: 8-02090-15445-4
3/8" Dr. T-47	15447	UPC: 8-02090-15447-8
3/8" Dr. T-50	15450	UPC: 8-02090-15450-8
3/8" Dr. T-55	15455	UPC: 8-02090-15455-3
HANG TAB	Master: 96 Inner: 12	



1/2" Dr.

Tamper Resistant Star Bit Sockets

- Chrome vanadium sockets with S-2 Alloy bits

1/2" Dr. T-60	15460	UPC: 8-02090-15460-7
HANG TAB	Master: 96 Inner: 12	



1/4" Dr. Star Bit Sockets

- Chrome vanadium sockets with S-2 Alloy bits

1/4" Dr. T-10	15510	UPC: 8-02090-15510-9
1/4" Dr. T-15	15515	UPC: 8-02090-15515-4
1/4" Dr. T-20	15520	UPC: 8-02090-15520-8
1/4" Dr. T-25	15525	UPC: 8-02090-15525-3
1/4" Dr. T-27	15527	UPC: 8-02090-15527-7
1/4" Dr. T-30	15530	UPC: 8-02090-15530-7
HANG TAB	Master: 96 Inner: 12	



3/8" Dr. Star Bit Sockets

- Chrome vanadium sockets with S-2 Alloy bits

3/8" Dr. T-40	15540	UPC: 8-02090-15540-6
3/8" Dr. T-45	15545	UPC: 8-02090-15545-1
3/8" Dr. T-47	15547	UPC: 8-02090-15547-5
3/8" Dr. T-50	15550	UPC: 8-02090-15550-5
3/8" Dr. T-55	15555	UPC: 8-02090-15555-0
HANG TAB	Master: 96 Inner: 12	



13 pc SAE Hex Bit Set

- 1/4" and 3/8" drive bit holders
- Sizes: 1/16, 3/32, 1/8, 9/64, 5/32, 3/16, 7/32, 1/4, 5/16, 3/8 & 7/16"
- Handy magnetic holder sticks to most metal surfaces
- S2 steel bits for strength and durability

16111 - CARDED
Master: 48 Inner: 6
UPC: 8-02090-16111-7



Magnetic Base

13 pc Metric Hex Bit Set

- 1/4" and 3/8" drive bit holders
- Sizes: 1.5, 2, 2.5, 3, 4, 5, 5.5, 6, 7, 8 and 10mm
- Handy magnetic holder sticks to most metal surfaces
- S2 steel bits for strength and durability

16112 - CARDED
Master: 48 Inner: 6
UPC: 8-02090-16112-4



Magnetic Base

13 pc Tamper Resistant Star Bit Set

- 1/4" and 3/8" drive bit holders
- Sizes: T8, T10, T15, T20, T25, T27, T30, T40, T45, T50 and T55
- Handy magnetic holder sticks to most metal surfaces
- S2 steel bits for strength and durability

16113 - CARDED
Master: 48 Inner: 6
UPC: 8-02090-16113-1



Magnetic Base

4 pc 3/8" Dr. Extra-Long Hex Bit Socket Set

- S2 alloy bits with chrome vanadium 3/8" dr. sockets
- Includes: 8mm, 10mm, 5/16" and 3/8" bit sockets

18190 - CARDED
Master: 48 Inner: 6
UPC: 8-02090-18190-0



8 pc 3/8" Dr. Ball End Hex Bit Socket Set

- Ball Ends allow access to fasteners in confined areas
- S2 Alloy bits with Chrome Vanadium sockets

METRIC BALL END HEX BITS
- Sizes: 3 through 10mm socket bits
16114 - CARDED
Master: 24 Inner: 6
UPC: 8-02090-16114-8

SAE BALL END HEX BITS
- Sizes: 1/8, 9/64, 5/32, 3/16, 7/32, 1/4, 5/16, 3/8" socket bits
16117 - CARDED
Master: 24 Inner: 6
UPC: 8-02090-16117-9



6 pc 3/8" Dr. Bit Socket Sets

- S2 Alloy bits with Chrome Vanadium sockets

SAE / METRIC HEX BITS
- Sizes: 1/4", 5/16", 3/8", 7mm, 8mm and 10mm socket bits
16115 - CARDED
Master: 24 Inner: 6
UPC: 8-02090-16115-2

Star BITS
- Sizes: 3/8" dr: T-40, T-45, T-47, T-50, and 1/2" dr: T-55 & T-60
16116 - CARDED
Master: 24 Inner: 6
UPC: 8-02090-16116-2



13 pc Star Bit Set

- Includes 1/4" dr. T10, T15, T20, T25, T27 and T30 bits; 3/8" dr. T40, T45, T47 and T50 bits; and 1/2" dr. T60 and T70 bits
- Chrome vanadium sockets with S-2 Alloy bits
- Anodized aluminum holder with magnetic insert sticks to most ferrous metal surfaces

16122 - CARDED

Master: 24 Inner: 6
UPC: 8-02090-16122-3

Magnetic Base



12 pc Tamper-Resistant Star Bit Set

- Includes 1/4" dr. T10, T15, T20, T25, T27 and T30 bits; 3/8" dr. T40, T45, T47 and T50 bits; and 1/2" dr. T60 bit
- Chrome vanadium sockets with S-2 Alloy bits
- Anodized aluminum holder with magnetic insert

16121 - CARDED

Master: 24 Inner: 6
UPC: 8-02090-16121-6

Magnetic Base

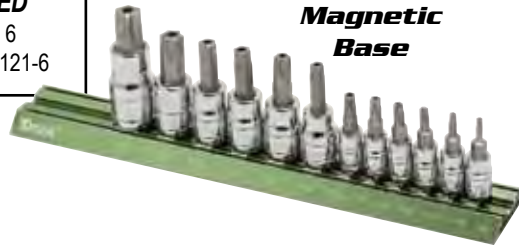

13 pc SAE Hex Bit Socket Set

- Anodized magnetic aluminum socket rail
- S2 alloy steel bits for strength and durability
- Rust resistant finish - Exceeds ANSI standards
- Sizes include:
1/4" Dr. - 5/64", 3/32", 7/64", 1/8", 9/64", 5/32"
3/8" Dr. - 3/16", 7/32", 1/4", 5/16", 3/8"
1/2" Dr. - 7/16", 1/2"

16123 - CARDED

Master: 24 Inner: 6
UPC: 8-02090-16123-0

Magnetic Base



13 pc METRIC Hex Bit Socket Set

- Anodized magnetic aluminum socket rail
- S2 alloy steel bits for strength and durability
- Rust resistant finish
- Exceeds ANSI standards
- Sizes include:
1/4" Dr. - 2, 2.5, 3, 4, 5, 5.5mm
3/8" Dr. - 6, 7, 8, 9, 10mm
1/2" Dr. - 11, 12mm

16124 - CARDED

Master: 24 Inner: 6
UPC: 8-02090-16124-7

Magnetic Base



6 pc 1/2" Dr. SAE Hex Bit Socket Set

- Anodized magnetic aluminum socket rail
- S2 alloy steel bits for strength and durability
- Rust resistant finish - Exceeds ANSI standards
- Sizes include: 9/16", 5/8", 11/16", 3/4", 13/16", 7/8"

16130 - CARDED

Master: 12 Inner: 4
UPC: 8-02090-16130-8

Magnetic Base



7 pc 1/2" Dr. METRIC Hex Bit Socket Set

- Anodized magnetic aluminum socket rail - S2 alloy steel bits
- Rust resistant finish - Exceeds ANSI standards
- Sizes include: 13, 14, 15, 17, 19, 21 & 22mm

16131 - CARDED

Master: 12 Inner: 4
UPC: 8-02090-16131-5

Magnetic Base



8 pc 1/2" Dr. SAE & Metric Hex Bit Socket Set

- Anodized magnetic aluminum socket rail
- S2 alloy steel bits for strength and durability
- Rust resistant finish
- Exceeds ANSI standards
- Sizes include:
9/16", 5/8", 11/16", 3/4"
14mm, 15mm, 17mm, 19mm

16132 - CARDED

Master: 12 Inner: 4
UPC: 8-02090-16132-2

Magnetic Base



8 pc 3/8" Dr. Spline Socket Set

- Chrome vanadium steel construction - Handy socket rail
- Also fits: 12 point (triple square), Star, 6 point, square and damaged fasteners

METRIC - 8,10, 12, 13, 14, 17, 18 & 19mm sockets

15202 - CARDED

Master: 24 Inner: 6
UPC: 8-02090-15202-3

SAE - 5/16, 3/8, 7/16, 1/2, 9/16, 5/8, 11/16 & 3/4" sockets

15203 - CARDED

Master: 24 Inner: 6
UPC: 8-02090-15203-0



13 pc E-Star Socket Set

- Contains 1 ea of the following sizes:
1/4" Dr: E-4, E-5, E-6, E-7, E-8
3/8" Dr: E-10, E-12, E-14, E-16
1/2" Dr: E-18, E-20, E-22, E-24
- Gold Aluminum Anodized Socket Rail
- CRV Construction

17403 - CARDED

Master: 24 Inner: 6
UPC: 8-02090-17403-2



Magnetic Base

21 pc EXO-Drive™ Socket Set

- Slim design with 5 degree sweep, 72 tooth ratchet mechanism for confined areas
- Chrome vanadium steel, fully polished and chrome plated
- 17 low profile sockets: 3/8, 7/16, 1/2, 9/16, 5/8, 11/16, 3/4" and 10 thru 19mm
- 1/4" & 3/8" dr. Quick Release adaptors
- 3" EXO-Drive™ extension

17400 - CARDED

Master: 10 Inner: 5
UPC: 8-02090-17400-1



Extended Reach Spark Plug Sockets

- 3/8" drive
- 5-1/8" length for recessed spark plugs
- Fully polished chrome vanadium steel

5/8"

17401 - HANG TAB

Master: 48 Inner: 12
UPC: 8-02090-17401-8

13/16"

17402 - HANG TAB

Master: 48 Inner: 12
UPC: 8-02090-17402-5



4 pc Socket Adapter Set

- Includes:
- 3/8" (F) to 1/4" (M)
- 1/4" (F) to 3/8" (M)
- 1/2" (F) to 3/8" (M)
- 3/8" (F) to 1/2" (M)
- Chrome vanadium steel construction

16104 - CARDED

Master: 24 Inner: 6
UPC: 8-02090-16104-9

32973 - DISPLAY

Master: 96 Inner: 6
UPC: 8-02090-32973-9



Impact Socket Adapters

- Chrome Moly Construction
- 1/2" Dr. F x 3/4" Dr. M
15224 - HANG TAB
Master: 48 Inner: 6 UPC: 8-02090-15224-5
- 3/4" Dr. F x 1/2" Dr. M
15225 - HANG TAB
Master: 48 Inner: 6 UPC: 8-02090-15225-2
- 3/4" Dr. F x 1" Dr. M
15226 - HANG TAB
Master: 48 Inner: 6 UPC: 8-02090-15226-9
- 1" Dr. F x 3/4" Dr. M
15227 - HANG TAB
Master: 48 Inner: 6 UPC: 8-02090-15227-6



7 pc Adapter and U-Joint Set

- Chrome vanadium steel construction (17407 - full polish), (17408 - black oxide finish)
- 4 adapter sizes: 1/4" F to 3/8" M; 3/8" F to 1/4" M; 3/8" F to 1/2" M; 1/2" F to 3/8" M
- 3 Universal joint sizes: 1/4", 3/8" and 1/2" dr.

17407 - CARDED

Master: 36 Inner: 6
UPC: 8-02090-17407-0

17408 - CARDED

Master: 36 Inner: 6
UPC: 8-02090-17408-7

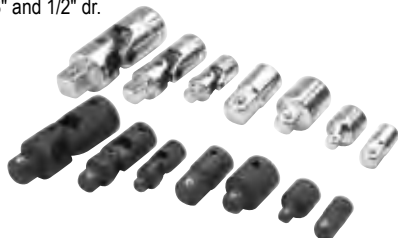

4 pc Socket & Bit Conversion Kit

- Convert ratcheting wrenches into socket & bit driver
- Chrome vanadium steel
- Quick locking & release
- Works with 10, 13, & 19mm wrenches

12624 - CARDED

Master: 96 Inner: 3
UPC: 8-02090-12624-6



Socket Adapters

- Chrome vanadium steel construction

- 1/4" Dr. F x 3/8" Dr. M **36157*** UPC: 8-02090-36157-9
- 3/8" Dr. F x 1/4" Dr. M **38159*** UPC: 8-02090-38159-1
- 3/8" Dr. F x 1/2" Dr. M **38158***** UPC: 8-02090-38158-4
- 1/2" Dr. F x 3/8" Dr. M **32157***** UPC: 8-02090-32157-3
- 1/2" Dr. F x 3/4" Dr. M **32158***** UPC: 8-02090-32158-0
- 3/4" Dr. F x 1/2" Dr. M **34157***** UPC: 8-02090-34157-1
- 3/4" Dr. F x 1" Dr. M **34158**** UPC: 8-02090-34158-8
- 1" Dr. F x 3/4" Dr. M **34159*** UPC: 8-02090-34159-5

HANG TAB

*Master: 60 Inner: 12

**Master: 24 Inner: 6

***Master: 36 Inner: 6

4 pc Socket Adapter Set

- Includes:
- 1/4" (F) to 3/8" (M)
- 3/8" (F) to 1/4" (M)
- 1/2" (F) to 3/8" (M)
- 3/8" (F) to 1/2" (M)
- Chrome vanadium steel construction

30932 - CARDED

Master: 24 Inner: 6
UPC: 8-02090-30932-8

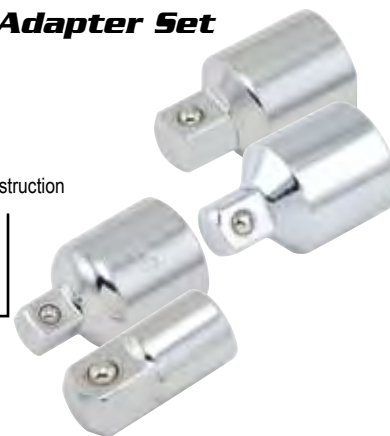

3 pc Universal Joint Set

- Drive sizes include: 1/4", 3/8", & 1/2" Dr
- Chrome Vanadium steel construction
- Limited Lifetime Warranty

30933 - CARDED

Master: 48 Inner: 12
UPC: 8-02090-30933-5



Universal Joints

1/4" DRIVE

36130 - HANG TAB
Master: 48 Inner: 12
UPC: 8-02090-36130-2

1/2" DRIVE

32130 - HANG TAB
Master: 48 Inner: 12
UPC: 8-02090-32130-6

3/8" DRIVE

38130 - HANG TAB
Master: 24 Inner: 6
UPC: 8-02090-38130-0

3/4" DRIVE

34130 - HANG TAB
Master: 48 Inner: 12
UPC: 8-02090-34130-4

3 pc Socket Adapter Set

- Adapts sockets to power drills and drivers
- Includes: 1/4" Dr. & 3/8" Dr Extension Bar
- 1/4" Shank
- 2-3/4" Overall Length
- Detent ball for secure socket retention

12082 - CARDED

Master: 120 Inner: 12
UPC: 8-02090-12082-4

32975 - DISPLAY

Master: 120 Inner: 6
UPC: 8-02090-32975-3



1/4" Drive Extensions

2"	36142*	UPC: 8-02090-36142-5
4"	36144*	UPC: 8-02090-36144-9
6"	36146**	UPC: 8-02090-36146-3
HANG TAB		*Master: 24 Inner: 6 **Master: 48 Inner: 12

3/4" Drive Extensions

4"	34144*	UPC: 8-02090-34144-1
8"	34148*	UPC: 8-02090-34148-9
16"	34151**	UPC: 8-02090-34151-9
HANG TAB		*Master: 48 Inner: 6 **Master: 16 Inner: 4

3/8" Drive Extensions

- Chrome vanadium steel construction

1-3/4"	38140*	UPC: 8-02090-38140-9
3"	38143*	UPC: 8-02090-38143-0
6"	38146*	UPC: 8-02090-38146-1
8"	38148*	UPC: 8-02090-38148-5
10"	38150**	UPC: 8-02090-38150-8
18"	38156***	UPC: 8-02090-38156-0
HANG TAB		*Master: 24 Inner: 12 **Master: 24 Inner: 6 ***Master: 48 Inner: 12

1/2" Drive Extensions

- Chrome vanadium steel construction

3"	32143*	UPC: 8-02090-32143-6
5"	32145**	UPC: 8-02090-32145-0
10"	32150***	UPC: 8-02090-32150-4
HANG TAB		*Master: 48 Inner: 12 **Master: 24 Inner: 12 ***Master: 24 Inner: 6

3 pc 1/2" Dr. Extension Sets

- Includes: 3", 5" and 8" lengths
- Chrome vanadium steel construction
- Fully polished and chrome plated

Standard Extension Set

32140 - HANG TAB
Master: 48 Inner: 12
UPC: 8-02090-32140-5

Wobble Extension Set

32141 - HANG TAB
Master: 48 Inner: 12
UPC: 8-02090-32141-2



4 pc 3/8" Dr. Extension Set

- Includes: 1-3/4", 3", 6" and 8" lengths
- Chrome vanadium steel construction
- Fully polished and chrome plated

Standard Extension Set

38152 - HANG TAB
Master: 48 Inner: 12
UPC: 8-02090-38152-2

Wobble Extension Set

38154 - HANG TAB
Master: 48 Inner: 12
UPC: 8-02090-38154-6



3 pc 1/4" Dr. Extension Set

- Contains 2", 4" & 6" lengths
- Chrome vanadium steel construction
- Fully polished and chrome plated

36940 - HANG TAB

Master: 48 Inner: 12
UPC: 8-02090-36940-7



Adjustable Extension Bars

- Locks at 7 adjustable lengths (1/4" Dr. - 6 adjustable lengths)
- Fully polished chrome vanadium steel construction

3/8" DRIVE (9" to 15")

12076 - CARDED
Master: 24 Inner: 6
UPC: 8-02090-12076-3

1/2" DRIVE (10" to 16")

12077 - CARDED
Master: 24 Inner: 6
UPC: 8-02090-12077-0

1/4" DRIVE (7-1/2" to 12-1/2")

12078 - CARDED
Master: 48 Inner: 6
UPC: 8-02090-12078-7



3 pc Extra-Long Extension Sets

- Includes: 18", 24", and 30" lengths
- Chrome vanadium steel construction
- Fully polished

3/8" DRIVE

12079 - HANG TAB
Master: 12 Inner: 6
UPC: 8-02090-12079-4

1/2" DRIVE

12081 - HANG TAB
Master: 6 Inner: 1
UPC: 8-02090-12081-7

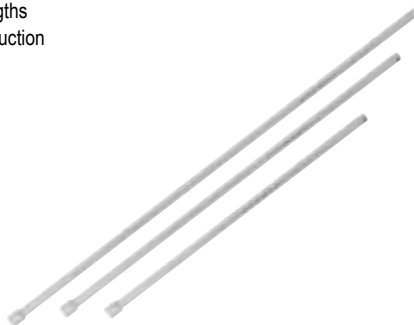

4 pc 2-Way Wobble Extension Set

- Includes 4 extensions:
 - 1/4" drive x 4"
 - 3/8" drive x 3"
 - 3/8" drive x 6"
 - 1/2" drive x 5"
- Fully polished chrome vanadium steel construction

12098 - HANG TAB

Master: 48 Inner: 12
UPC: 8-02090-12098-5



3 pc Wobble Extension Set

- Includes 3 extensions:
 - 1/4" drive x 2"
 - 3/8" drive x 2"
 - 1/2" drive x 2"
- Fully polished chrome vanadium steel construction

16105 - CARDED

Master: 72 Inner: 12
UPC: 8-02090-16105-6



3 pc Quick Release Extension Set

- Includes 3 extensions:
 - 1/4" drive x 6"
 - 3/8" drive x 10"
 - 1/2" drive x 10"
- Quick Release button
- Knurled for better grip
- Fully polished chrome vanadium steel construction

16118 - CARDED

Master: 30 Inner: 5
UPC: 8-02090-16118-6



1/2" Dr. Anodized Aluminum Magnetic Socket Rails

- Holds 14 sockets - Accepts standard and deep sockets
- Sizes marked on rails for easy identification
- Super strong magnet for solid placement

SAE - Holds sizes: 3/8-1-1/4"

32097 - POLY BAG

Master: 24 Inner: 6
UPC: 8-02090-32097-2

METRIC - Holds sizes: 10-22mm & U-joint

32098 - POLY BAG

Master: 24 Inner: 6
UPC: 8-02090-32098-9

LARGE MM - Holds sizes: 23-36mm

32099 - POLY BAG

Master: 24 Inner: 6
UPC: 8-02090-32099-6

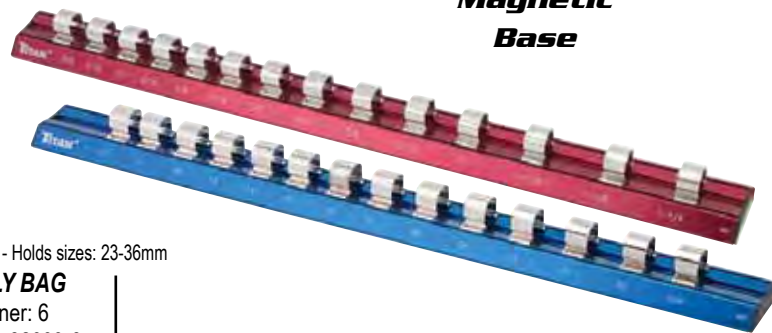

Magnetic Base

3/8" Dr. Anodized Aluminum Magnetic Socket Rails

- Holds 14 sockets & u-joints - Accepts standard and deep sockets
- Sizes marked on rails for easy identification
- Super strong magnet for solid placement

SAE - Holds sizes: 1/4-1"

38097 - POLY BAG

Master: 24 Inner: 6
UPC: 8-02090-38097-6

METRIC - Holds sizes: 6-19mm

38098 - POLY BAG

Master: 24 Inner: 6
UPC: 8-02090-38098-3

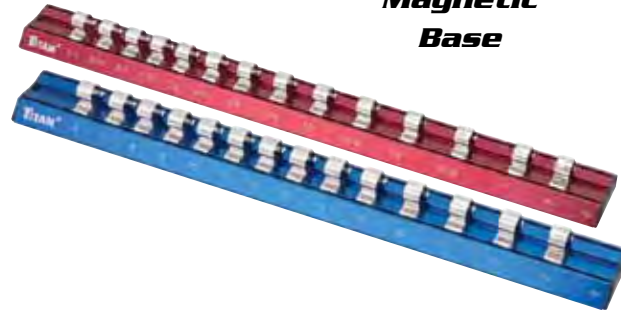

Magnetic Base

1/4" Dr. Anodized Aluminum Magnetic Socket Rails

- Holds 12 sockets, adapters & u-joints - Accepts standard and deep sockets
- Sizes marked on rails for easy identification
- Super strong magnet for solid placement

SAE - Holds sizes: 5/32-1/2"

36097 - POLY BAG

Master: 24 Inner: 6
UPC: 8-02090-36097-8

METRIC - Holds sizes: 4-13mm

36098 - POLY BAG

Master: 24 Inner: 6
UPC: 8-02090-36098-5

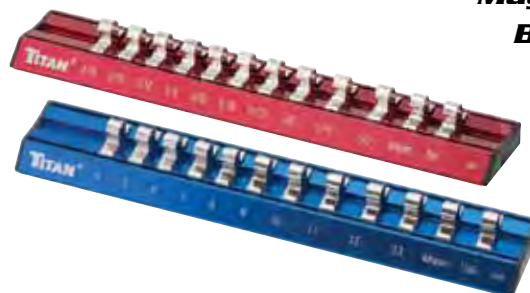

Magnetic Base

1/2" Dr. 12 Point Axle Nut Socket

- For removal and installation of axle nut and automatic transmission tail output shafts
- 1/2" Drive
- Impact quality

15230 30mm - HANG TAB

Master: 24 Inner: 6 UPC: 8-02090-15230-6

15232 32mm - HANG TAB

Master: 24 Inner: 6 UPC: 8-02090-15232-0

15234 34mm - HANG TAB

Master: 24 Inner: 6 UPC: 8-02090-15234-4

15236 36mm - HANG TAB

Master: 24 Inner: 6 UPC: 8-02090-15236-8

15239 39mm - HANG TAB

Master: 24 Inner: 6 UPC: 8-02090-15239-9



1/2" Dr. 6 Point Axle Nut Socket

- For removal and installation of axle nut and automatic transmission tail output shafts
- 1/2" Drive
- Impact quality

15328 28mm - HANG TAB

Master: 24 Inner: 6 UPC: 8-02090-15328-0

15329 29mm - HANG TAB

Master: 24 Inner: 6 UPC: 8-02090-15329-7

15330 30mm - HANG TAB

Master: 24 Inner: 6 UPC: 8-02090-15330-3

15331 31mm - HANG TAB

Master: 24 Inner: 6 UPC: 8-02090-15331-0

15332 32mm - HANG TAB

Master: 24 Inner: 6 UPC: 8-02090-15332-7

15333 33mm - HANG TAB

Master: 24 Inner: 6 UPC: 8-02090-15333-4

15334 34mm - HANG TAB

Master: 24 Inner: 6 UPC: 8-02090-15334-1

15335 35mm - HANG TAB

Master: 24 Inner: 6 UPC: 8-02090-15335-8

15336 36mm - HANG TAB

Master: 24 Inner: 6 UPC: 8-02090-15336-5

15338 38mm - HANG TAB

Master: 24 Inner: 6 UPC: 8-02090-15338-9



Precision Oiler

- Push button delivery system allows precise control over placement of lubricant
- Machined aluminum body for extended life
- Designed for intricate and delicate machinery

15200 - CARDED

Master: 96 Inner: 12
UPC: 8-02090-15200-9



Honda / Acura Crankshaft Pulley Holder

- For use on most Honda & Acura applications 1992 & later
- Allows for stationary positioning of the crankshaft when servicing the engine and powertrain
- For removal and installation of the crankshaft pulley

51700 - CARDED

Master: 24 Inner: 6
UPC: 8-02090-51700-6



Fuel & A/C Line Disconnect Tool

- For fast and easy separation of quick disconnect style fittings
- For use on 3/8", 1/2", 5/8", 3/4" lines with quick disconnect fittings
- Necessary for fuel, heater, and A/C line service on many late model vehicles

51613 - CARDED

Master: 72 Inner: 6
UPC: 8-02090-51613-9



Fuel Line Disconnect Tool

- For fast and easy separation of quick disconnect style fittings
- For use on both 5/16" & 3/8" fuel lines with quick disconnect fittings
- Necessary for fuel filter replacement & service on many late model vehicles
- For use on many applications including:
 - GM: 1989 thru current
 - Ford: 1990 thru current
 - Mazda: 1990 thru current

51614 - CARDED

Master: 72 Inner: 6
UPC: 8-02090-51614-6



3 pc Stainless Steel Scraper & Putty Knife Set

- 1-1/4" Scraper - Rigid stainless steel Go-thru blade with metal capped handle for strength & durability
- 1-1/4" and 3" Putty Knives
- Flexible stainless steel blades for easier application of fillers and putties
- All tools feature comfortable TPR grips

17000 - CARDED

Master: 12 Inner: 6
UPC: 8-02090-17000-3



2 pc Multi-Purpose Razor Scraper Set

- Ideal for scraping labels and decals from glass, windshields, etc.
- Large scraper with TPR handle for maximum grip
- Mini razor scraper made of tough polypropylene with TPR sleeve and safety cap
- Extra-heavy-duty .020" razor blades
- Includes 5-pack of replacement blades

17002 - CARDED

Master: 48 Inner: 6
UPC: 8-02090-17002-7



Multi-Purpose Razor Scraper

- For scraping labels & decals from glass, windshields, etc.
- Comfortable TPR handle for maximum grip
- Includes one extra-heavy duty .020" razor blade - over twice as thick as a standard razor blade
- Uses Titan replacement blades 11036, 11038 or 11039

11030 - COUNTER DISPLAY

Master: 48 Inner: 6
UPC: 8-02090-11030-6

12030 - CARDED

Master: 36 Inner: 6
UPC: 8-02090-12030-5



Mini Razor Scraper

- Tough polypropylene construction
- TPR comfort sleeve for better grip and more control
- Includes one extra-heavy duty .020" razor blade - over twice as thick as a standard razor blade
- Protective safety cap
- Uses Titan replacement blades 11036, 11038 or 11039

11031 - COUNTER DISPLAY

Master: 96 Inner: 12
UPC: 8-02090-11031-3

12031 - CARDED

Master: 72 Inner: 12
UPC: 8-02090-12031-2

32967 - COUNTER DISP.

Master: 36 Inner: 6
UPC: 8-02090-32967-8



6-in-1 Paint Scraper

- Polished stainless steel blade
- Comfortable TPR handle for maximum grip
- Ships bulk in 6 pc counter display
- 6-in-1: Wall scraper, paint roller cleaner, paint remover, nail and tack remover, putty and grout remover, putty knife

11510 - COUNTER DISPLAY

Master: 48 Inner: 6
UPC: 8-02090-11510-3



3" Offset Stainless Steel Scraper

- Rigid stainless steel blade for strength & durability
- Comfortable TPR handle for maximum grip
- Offset design for hard to reach areas

11504 - COUNTER DISPLAY

Master: 48 Inner: 6
UPC: 8-02090-11504-2

12503 - CARDED

Master: 72 Inner: 6
UPC: 8-02090-12503-4



Stainless Steel Scrapers

- Rigid stainless steel Go-Thru blade, metal capped handle for strength & durability
- Comfortable TPR handle for maximum grip

1-1/4" OFFSET

11508 - COUNTER DISPLAY

Master: 48 Inner: 6
UPC: 8-02090-11508-0

1-1/4" OFFSET

12505 - CARDED

Master: 72 Inner: 6
UPC: 8-02090-12505-8

1-1/4" STRAIGHT

11500 - COUNTER DISPLAY

Master: 48 Inner: 6
UPC: 8-02090-11500-4

1-1/4" STRAIGHT

12501 - CARDED

Master: 72 Inner: 6
UPC: 8-02090-12501-7

2" STRAIGHT

12502 - CARDED

Master: 72 Inner: 6
UPC: 8-02090-12501-7



3 pc Prybar / Scraper Set

- Contains 3 sizes: 5-1/2", 7-1/4" and 9-1/4"
- Stainless steel construction with mirror polished finish
- Sharp scraper edges
- Use as prybars, scrapers, chisels or tack pullers

17007 - CARDED
 Master: 12 Inner: 6
 UPC: 8-02090-17007-2



2 pc Stainless Steel Prybar / Scraper Set

- Rigid stainless steel construction
- Razor sharp scraper edges
- Ideal for nail & tack pulling, prying and scraping

17005 - CARDED
 Master: 48 Inner: 6
 UPC: 8-02090-17005-8



2 pc Mini Pry Bar / Scraper Set

- 5-1/2" x 7/8" prybar/scrapper
- 5-1/2" x 9/16" wrecking bar
- Stainless steel construction with mirror polished finish
- Sharp scraper edges
- Use as prybars, scrapers, chisels or tack pullers

17006 - CARDED
 Master: 36 Inner: 6
 UPC: 8-02090-17006-5



Mini Wrecking Bar

- Compact 5-1/2" x 9/16" size - Sharp scraper edges
- Stainless steel construction with mirror polished finish
- Use as prybar, scraper, chisel or tack puller

11506 - COUNTER DISPLAY
 Master: 48 Inner: 12
 UPC: 8-02090-11506-6

32974 - COUNTER DISPLAY
 Master: 72 Inner: 12
 UPC: 8-02090-32974-6



Multi-Purpose Prybar

- Stainless steel construction with mirror polished finish
- Nail puller
- Razor sharp edges for scraping

11509 - COUNTER DISPLAY
 Master: 48 Inner: 12
 UPC: 8-02090-11509-7

32970 - COUNTER DISPLAY
 Master: 36 Inner: 6
 UPC: 8-02090-32970-8



Mini Prybar / Scraper

- Compact 5-1/2" x 7/8" size
- Stainless steel construction with mirror polished finish
- Sharp scraper edges
- Use as prybar, scraper, chisel or tack puller

11505 - COUNTER DISPLAY
 Master: 48 Inner: 12
 UPC: 8-02090-11505-9



8" Mini Pry Bar

- Comfortable TPR soft grip handle
- Chrome vanadium steel shaft with sand satin finish

11512 - COUNTER DISPLAY
 Master: 96 Inner: 12
 UPC: 8-02090-11512-7



8" Multi-Purpose Nail Puller & Pry Bar

- Nail/ tack puller doubles as a hammer
- Thin wide pry bar blade minimizes surface damage
- Drop forged heat treated steel

12208 - CARDED
 Master: 48 Inner: 6
 UPC: 8-02090-12208-8



1-1/4" Semi Flexible Scraper

- Semi-flexible steel blade
- Easy to clean handle with hang hole for storage

12025 - CARDED

Master: 144 Inner: 12
UPC: 8-02090-12025-1



3 Position FOLDING Scraper

- Effectively removes stickers, paint, tape and varnish from glass, porcelain and steel
- 3-position lock for use in different areas
- Blade folds under handle for safety and compact storage
- Uses Titan replacement blades 11036, 11038 or 11039

12029 - CARDED

Master: 144 Inner: 12
UPC: 8-02090-12029-9



1" Gasket / Carbon Scraper

- Semi-flexible steel blade
- Easy to clean handle with hang hole for storage

12462 - CARDED

Master: 72 Inner: 12
UPC: 8-02090-12462-4



1" Gasket / Carbon Scraper with Bolstered Handle

- Chrome vanadium construction
- 1" wide scraper blade
- Comfortable trilobular handle for maximum grip
- Go-thru bolstered handle

12463 - CARDED

Master: 72 Inner: 12
UPC: 8-02090-12463-1



3" Refinishing Tool

- Use with paint and varnish removers to strip painted surfaces for refinishing

11503 - LABEL

Master: 100 Inner: 10
UPC: 8-02090-11503-5

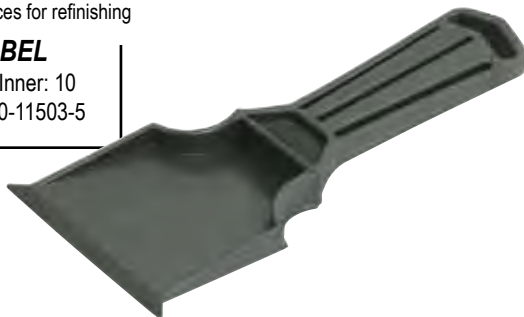

4 pc Pry Bar Set

- TPR soft grip handles
- Chrome vanadium steel shafts with sand satin finish
- Includes 8, 12, 18 and 24" pry bars

4 pc Pry Bar Set - Black Handles

17102 - CARDED

Master: 5 Inner: 1
UPC: 8-02090-17102-4

4 pc Pry Bar Set - Yellow Handles

17101 - CARDED

Master: 6 Inner: 1
UPC: 8-02090-17101-7



Indexable Pry Bars

- Ideal for prying seals, bearings, manifolds, oil pans, axles, drive shafts and fuel injectors
- Indexing head locks at 8 incrementally fixed angles
- Thumb knob for quick & easy lock & release of pry head
- High carbon steel construction

10" Pry Bar

12210 - HANG TAB

Master: 40 Inner: 5 UPC: 8-02090-12210-1

12" Pry Bar

12212 - HANG TAB

Master: 40 Inner: 10 UPC: 8-02090-12212-5

15" Pry Bar

12215 - HANG TAB

Master: 40 Inner: 10 UPC: 8-02090-12215-6



3 pc Indexable Pry Bar Set

- Includes 10", 12" and 15" pry bars

12216 - BOXED

Master: 10 Inner: 1
UPC: 8-02090-12216-3

24" Indexable Pry Bar

- Includes 10", 12" and 15" pry bars

12224 - HANG TAB

Master: 6 Inner: 3
UPC: 8-02090-12224-8

QUICK READ Cushion Grip Tape Measures

- Easy, quick-read markings
- Tough, impact resistant plastic case
- Ergonomic cushion grips
- Hands-free blade lock

12 ft. x 5/8" TAPE MEASURE

11112 - CARDED

Master: 48 Inner: 6
UPC: 8-02090-11112-9

16 ft. x 3/4" TAPE MEASURE

11116 - CARDED

Master: 48 Inner: 6
UPC: 8-02090-11116-7

25 ft. x 1" TAPE MEASURE

11125 - CARDED

Master: 36 Inner: 6
UPC: 8-02090-11125-9

33 ft. x 1" TAPE MEASURE

11133 - CARDED

Master: 24 Inner: 6
UPC: 8-02090-11133-4

QUICK READ Cushion Grip Tape Measure Sets

- Easy, quick-read markings
- Tough, impact resistant plastic cases
- Ergonomic cushion grips for maximum comfort
- Hands-free blade locks
- 4 pc set (17500) contains: 12', 16', 25' and 33' tapes

2 pc 16' SET

10997 - CARDED

Master: 24 Inner: 6
UPC: 8-02090-10997-3

2 pc 25' SET

10999 - CARDED

Master: 24 Inner: 6
UPC: 8-02090-10999-7

4 pc TAPE MEASURE SET

17500 - CARDED

Master: 12 Inner: 6
UPC: 8-02090-17500-8



2 pc DUAL-RULE™ Combination Tape Measure Set

- Dual-Rule™ Standard and Metric scales
- Quick-Read blade markings
- Comfort grip sleeve
- Hands free blade lock
- Includes 16 ft. and 25 ft. tapes

17502 - CARDED

Master: 24 Inner: 6
UPC: 8-02090-17502-2



25 ft. DUAL-RULE™ Combination Tape Measure

- Dual-Rule™ Standard and Metric scales
- Quick-Read blade markings
- Comfort grip sleeve
- Hands free blade lock

11126 - CARDED

Master: 36 Inner: 6
UPC: 8-02090-11126-6



165 ft. FAST REWIND Tape Measure

- 3:1 Rewind gear ratio
- Dual purpose folding end hook for secure anchoring
- Comfortable rubberized hand grip
- Magnet on bottom of case secures end hook when retracted

11150 - CARDED

Master: 12 Inner: 3
UPC: 8-02090-11150-1



100 ft. FAST REWIND Tape Measure

- 3:1 Rewind gear ratio
- Dual purpose folding end hook for secure anchoring
- Comfortable rubber cushion grip

11100 - CARDED

Master: 24 Inner: 6
UPC: 8-02090-11100-6



Electronic Digital Caliper with FRACTIONAL Display

- Inside, outside, step, depth & scribe measurements
- 6" range (150mm) - AUTO SHUT OFF
- Set zero at any position in measuring range
- Fine adjust thumbwheel - Lock knob
- Stainless steel components
- Protective storage case - Includes 2 batteries

23173 - CARDED

Master: 24 Inner: 6
UPC: 8-02090-23173-5

AUTO SHUT OFF!



Electronic Digital Caliper

- Use for inside, outside and depth measurements
- 6" range (150mm) - AUTO SHUT OFF
- Easy to read large LCD display
- Set zero at any position in measuring range
- Fine adjust thumbwheel - Lock knob - Stainless steel components
- Protective storage case - Includes 2 batteries

23175 - CARDED

Master: 48 Inner: 12
UPC: 8-02090-23175-9

AUTO SHUT OFF!



10 pc Utility Knife Blades

- Heavy duty blades - Ideal for general purpose cutting

11034 - CARDED

Master: 480 Inner: 40 UPC: 8-02090-11034-4



10 pc 18mm Snap-Off Knife Blades

- 8 Cutting points per blade

11035 - CARDED

Master: 300 Inner: 30 UPC: 8-02090-11035-1



Mini Sliding Utility Knife Blades

11032 - CARDED

Master: 144 Inner: 6 UPC: 8-02090-11032-7

Folding Pocket Utility Knife

- Quick change blade requires no tools - Folding lock for safety
- Easy carry belt clip - 5 extra blades in handy dispenser

11015 - CARDED

Master: 48 Inner: 12
UPC: 8-02090-11015-3



11015

11018 - CARDED

Master: 48 Inner: 12
UPC: 8-02090-11018-4

Twin Pack Utility Pocket Knife

11020 - CARDED

Master: 48 Inner: 12
UPC: 8-02090-11020-7



11018

100 pc Single Edge Razor Blades

- Heavy duty blades - 8 Cutting points per blade

#9 Blades, .009" Thick

11036 - CARDED

Master: 48 Inner: 6 UPC: 8-02090-11036-8

#12 Blades, .012" Thick

11038 - CARDED

Master: 48 Inner: 6 UPC: 8-02090-11038-2

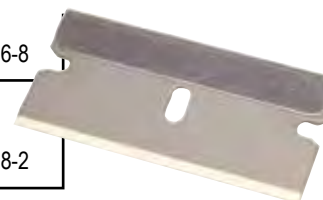

20 pc X-Heavy Duty #20 Razor Blades

- Over twice as thick as a standard razor blade

11039 - CARDED

Master: 36 Inner: 6 UPC: 8-02090-11039-9

Mini Retractable Utility Knife

- Quick change blade mechanism
- Smooth retracting/locking blade advance
- TPR molded for better grip - 3" closed, 4-1/4" fully open
- Attaches to keychain or lanyard
- Use Titan #11032 replacement blades
- Includes 3 extra blades

32968 - DISPLAY

Master: 96 Inner: 6
UPC: 8-02090-32968-5



Retractable Utility Knife

- Quick change blade mechanism
- Smooth retracting/locking blade advance
- TPR molded for better grip
- 4-1/2" closed, 6-7/8" fully open
- Use Titan #11034 replacement blades
- Includes 3 extra blades

11024 - CARDED

Master: 48 Inner: 12
UPC: 8-02090-11024-5



Auto-Loading Breakaway Knife

- Break dull tips off to expose new sharp edge
- Blade retracts for safety - Heavy duty die cast body
- TPR Grips for comfort and positive grip - Locking safety knob
- Slide knob back then forward to automatically load new blade from cartridge
- Cartridge holds 8 extra blades

11027 - CARDED

Master: 36 Inner: 6
UPC: 8-02090-11027-6



Auto-Loading Utility Knife

- Slide knob back then forward to automatically load new blade
- Blade retracts for safety - Heavy duty die cast body
- TPR Grips for comfort and positive grip - Knife holds 10 extra blades

11026 - CARDED

Master: 36 Inner: 6
UPC: 8-02090-11026-9



Multi-Purpose Utility Shears

- Stainless steel blades - Adjustable pivot point for variable blade tension
- Extended tang - TPR plastic handles - Ergonomic handles for comfort
- Excellent for cutting rubber, upholstery, plastic, canvas, fabric, string and more

10" SHEARS

12310 - CARDED

Master: 144 Inner: 12
UPC: 8-02090-12310-8



8" SHEARS

12308 - CARDED

Master: 48 Inner: 6
UPC: 8-02090-12308-5



4" Precision Shears

- Ideal for cutting rubber, paper, thread, fabric, string, crafts and many other materials
- Stainless steel precision ground and hardened blades for long-lasting edge
- Ergonomic handles for comfort
- Left or right hand usage - Extended tang for durability
- Specially designed tip to access tight spaces

12341 - CARDED

Master: 144 Inner: 12
UPC: 8-02090-12341-2



5-3/4" Mini Multi-Purpose Shears

- Serrated blades for easier cutting
- Excellent for cutting rubber upholstery, plastic, canvas, fabric, string and many other materials
- Lightweight handles with ergonomic overmolded TPR grips to reduce user fatigue

12340 - CARDED

Master: 72 Inner: 12
UPC: 8-02090-12340-5



7-1/2" Multi-Purpose Shears

- SUS 420J2 Japanese stainless steel, precision ground and hardened for long lasting sharp cutting edge
- Lightweight Polypropylene handles with ergonomic overmolded TPR grips to reduce user fatigue
- Spring loaded handles for easy use
- Extended tang for durability

12345 - CARDED

Master: 48 Inner: 6
UPC: 8-02090-12345-0



8" Multi-purpose Offset Shears

- Ideal for cutting wire, wood, rope, cord, cardboard, plastic, rubber, leather and many other materials
- Stainless steel, precision ground and hardened blades
- Ergonomic comfort handles allow left or right hand usage
- Extra tang for durability
- One blade partially serrated for extra cutting action
- Overall length: 160 mm
- Cutting length: 42mm

12348 - CARDED

Master: 48 Inner: 6
UPC: 8-02090-12348-1



5-1/2" Multi-Purpose Electrical Shears

- Heavy duty high carbon stainless steel with molybdenum and vanadium blades, precision hollow-ground and hardened for long-lasting edge.
- Ergonomic handles allow for both left and right hand usage
- Micro-serration blades reduce slippage
- Light weight - Includes handy belt holster

12346 - CARDED

Master: 48 Inner: 6
UPC: 8-02090-12346-7



Aviation Snips

- Meets or exceeds federal ANSI/ASME spec B107.16-1998
- Chrome molybdenum steel construction
- Induction hardened, serrated edged blades
- Compound leverage cutters
- Cuts cold rolled and stainless steel
- Ships on re-usable holster package



Straight Cut Snips

11460 - HANG TAB

Master: 36 Inner: 6 UPC: 8-02090-11460-1

Right Cut Snips

11461 - HANG TAB

Master: 36 Inner: 6 UPC: 8-02090-11461-8

Left Cut Snips

11462 - HANG TAB

Master: 36 Inner: 6 UPC: 8-02090-11462-5

Offset Aviation Snips

- Offset cutting blades
- Meets or exceeds federal ANSI/ASME spec B107.16-1998
- Same great features & benefits as our Aviation Snips.

Right Cut (green)
11472 - HANG TAB

Master: 36 Inner: 6
UPC: 8-02090-11472-4

Left Cut (red)
11473 - HANG TAB

Master: 36 Inner: 6
UPC: 8-02090-11473-1



Vertical Aviation Snips

- Meets or exceeds federal ANSI/ASME spec B107.16-1998
- Chrome molybdenum steel construction
- Induction hardened, serrated edged blades
- Compound leverage cutters
- Cuts cold rolled and stainless steel
- Ships on re-usable holster package

Right Cut
11466 - HANG TAB

Master: 36 Inner: 6
UPC: 8-02090-11466-3

Left Cut
11467 - HANG TAB

Master: 36 Inner: 6
UPC: 8-02090-11467-0



Compound Action Cable Cutter

- 10" overall length
- Drop forged Chrome-Molybdenum Alloy steel blades
- Compound leverage increases cutting power
- Spring-free automatic latch design (one hand release)
- Cuts the following: Copper and aluminum electric cable up to 2AWG (14mm) or 1/2" (12mm) diameter
- Includes reusable holster

11470 - HANG TAB

Master: 36 Inner: 6
UPC: 8-02090-11470-0



Extra-Long Utility Snips

- 11.25" overall length
- Meets or exceeds federal ANSI specification B107.16-1998
- Chrome-moly steel construction
- Induction hardened, serrated blades
- Compound leverage cutters
- Cuts cold rolled and stainless steel
- Includes reusable holster

11471 - HANG TAB

Master: 36 Inner: 6
UPC: 8-02090-11471-7



Tinner Snips

- All purpose straight pattern snips
- Meets or exceed federal specification ANSI / ASME B107.16.1998
- Drop forged high carbon steel
- Induction hardened cutting edges

10" Tinner Snips
12440 - CARDED

Master: 36 Inner: 6
UPC: 8-02090-12440-2

7" Tinner Snips
12447 - CARDED

Master: 36 Inner: 6
UPC: 8-02090-12447-1



Heavy Duty Hacksaw

- For 55 degree and right angles
- Strong, well-balanced design for the professional user
- Comfortable aluminum handle
- Deep cutting, sturdy steel frame w/ excellent strength-to-weight ratio
- Uses 12" saw blades, Titan's replacement blades: 11802 Tungsten Carbide, 11817 Bi-metal, 11853 Carbon Steel

11079 - CARDED

Master: 36 Inner: 12
UPC: 8-02090-11079-5



Hacksaw Blades

Tungston Carbide Blades

11802 - CARDED
Master: 100 Inner: 10
UPC: 8-02090-11802-9

Bi-Metal Blades

11817 - CARDED
Master: 120 Inner: 12
UPC: 8-02090-11817-3

Carbon Steel Blades

11853 - CARDED
Master: 144 Inner: 12
UPC: 8-02090-11853-1



Quick Release

Close Quarters Hacksaw

- Rugged die-cast alloy handle - Ergonomic molded rubber grip
- Accepts standard hacksaw blades - 4" range of blade length adjustment
- Quick release lever lock for fast and easy blade changes

11080 - COUNTER DISPLAY

Master: 40 Inner: 10
UPC: 8-02090-11080-1



3 pc Seam Splitter Set

- Indispensable tools for separating spot-welded body panels for auto body repair work
- Tough chrome vanadium steel go-through shafts
- Shock dampening TPR comfort grips
- Includes straight, 30° offset and 90° offset seam splitters

11563 - DISPLAY BOX

Master: 12 Inner: 1
UPC: 8-02090-11563-9



90° Angle Seam Splitter

11562 - BULK
Master: 36 Inner: 6
UPC: 8-02090-11562-2

30° Offset Seam Splitter

11561 - BULK
Master: 36 Inner: 6
UPC: 8-02090-11561-5

Straight Seam Splitter

11560 - BULK
Master: 36 Inner: 6
UPC: 8-02090-11560-8

4 pc Super Scraper Set

- Remove gaskets and debris from aluminum parts without damaging part
- Remove decals, emblems and body molding without scratching painted surfaces
- Designed to absorb hammer blows
- Nylon plastic can be re-sharpened with file
- Includes 4 scrapers:
3/4", 7/8", 1" & 1-1/2" x 10-3/4" length

11564 - CARDED

Master: 12 Inner: 6
UPC: 8-02090-11564-6

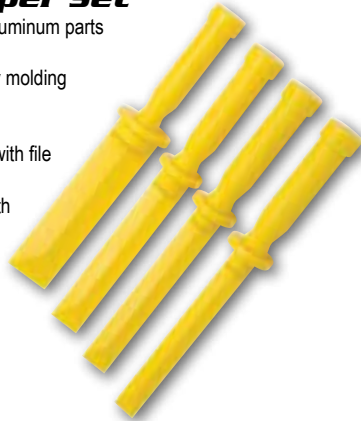

7/8" Super Scraper

- Remove gaskets and debris from aluminum parts without damaging part
- Remove decals, emblems and body molding without scratching painted surfaces
- Designed to absorb hammer blows
- Nylon plastic can be re-sharpened with file
- 7/8" x 10-3/4" length

11567 - CARDED

Master: 72 Inner: 12
UPC: 8-02090-11567-7

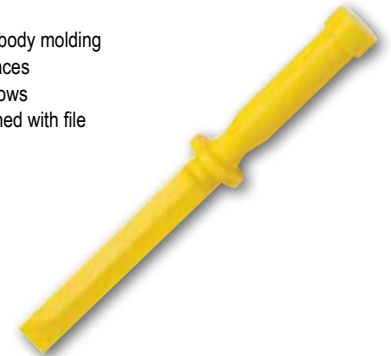

6 pc Mini Panel Removal Set

- Specially designed slim profile
- Shaped for many different applications such as removing dashboards, air vents, door panels, door locks, electronic seat controls, seat levers, center consoles, gear shifter and more
- High quality nylon material prevents scratches to painted surfaces and delicate panel surfaces

11566 - CARDED

Master: 48 Inner: 12
UPC: 8-02090-11566-0



Door Spring Tool

- Designed to quickly and easily remove or install car door hinge springs
- Services GM cars and GM light duty trucks
- Can be used with a 1/2" open end or ratcheting box wrench

15040 - CARDED

Master: 48 Inner: 6
UPC: 8-02090-15040-1



60 pc Screwdriver Display

- 10 each of the most popular screwdrivers including:
- #2 x 4" Phillip (part # 11230) #1 x 3" Phillips (part #11231)
- 1/4" x 4" Slotted (part #11232) 3/16" x 3" Slotted (part #11233)
- T15 x 4" Star (part # 11234) R2 x 4" Square (part # 11235)
- Magnetic Tip - Chrome Vanadium - Ergonomic handle

98022 - BULK

Master: 1 Inner: 1 UPC: 8-02090-98022-0



SCREWDRIVERS

- Magnetic tip - Chrome vanadium shaft
- Easy read tip indicator - Ergonomic handle

#2 X 4" Phillips	11230	UPC: 8-02090-11230-0
#1 X 3" Phillips	11231	UPC: 8-02090-11231-7
1/4" X 4" Slotted	11232	UPC: 8-02090-11232-4
3/16" X 3" Slotted	11233	UPC: 8-02090-11233-1
T-15 X 4" Star	11234	UPC: 8-02090-11234-8
R2 X 4" Square	11235	UPC: 8-02090-11235-5

BULK Master: 100 Inner: 25



7 pc Screwdriver Set

- Contains:
- #0 x 3", #1 x 3" & #2 x 4" Phillips
- 1/8" x 3", 3/16" x 3", 1/4" x 4" & 5/16" x 6" Slotted
- Comfortable TPR grips
- Chrome vanadium shafts

17247 - CARDED

Master: 12 Inner: 6
UPC: 8-02090-17247-2

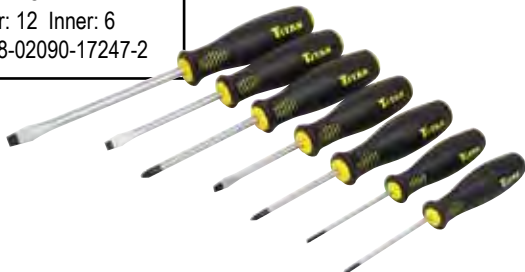

Comfort Grip SCREWDRIVERS

- Ergonomic soft grip handle for maximum comfort - Chrome vanadium steel shaft
- Magnetic tips - Hex bolster for stubborn screws

3/16" X 3" Slotted	11245	UPC: 8-02090-11245-4
1/4" X 4" Slotted	11247	UPC: 8-02090-11247-8
1/4" X 6" Slotted	11248	UPC: 8-02090-11248-5
5/16" X 6" Slotted	11249	UPC: 8-02090-11249-2
3/8" X 12" Slotted	11252	UPC: 8-02090-11252-2
#1 X 3" Phillips	11256	UPC: 8-02090-11256-0
#2 X 4" Phillips	11260	UPC: 8-02090-11260-7
#3 X 6" Phillips	11264	UPC: 8-02090-11264-5
T-15 x 4" Star	11267	UPC: 8-02090-11267-6
T-20 x 4" Star	11268	UPC: 8-02090-11268-3

HANG TAB

Master: 72 Inner: 6



8 pc Screwdriver Set

- Ergonomic soft grip handle for maximum comfort - Chrome vanadium steel shafts
- Magnetic tips - Re-usable storage tray
- Hex bolsters for stubborn screws (on larger drivers)
- 6" x 5/16" Slotted 6" x #3 Phillips
- 4" x 1/4" Slotted 4" x #2 Phillips
- 3" x 3/16" Slotted 3" x #1 Phillips
- Stubby 1/4" Slotted Stubby #2 Phillips

17208 - CARDED

Master: 12 Inner: 6
UPC: 8-02090-17208-3



4 pc GO-THRU Screwdriver Set

- GO-THRU Shafts extend thru handle to metal capped end
- Chrome vanadium shafts with magnetic tips
- Hex bolsters allow you to loosen stubborn screws with a wrench
- Ergonomic soft grip handle for maximum comfort - Sizes clearly marked on handle
- Includes: 6" x 5/16" Slotted 6" x #3 Phillips
- 4" x 1/4" Slotted 4" x #2 Phillips

17220 - CARDED

Master: 12 Inner: 6
UPC: 8-02090-17220-5



Fits-All Phillips Screwdriver

- Patented tip design fits all popular Phillips screw sizes
- Screwdriver shaft has fits-all Phillips on one end and 1/4" slotted at other end
- Chrome plated S2 Alloy steel shaft
- Ergonomic TPR comfort grip
- Interactive counter display features assorted screws to demonstrate fits-all tip

11009 - COUNTER DISPLAY

Master: 80 Inner: 10
UPC: 8-02090-11009-2

32961 - COUNTER DISPLAY

Master: 54 Inner: 9
UPC: 8-02090-32961-6



6 in 1 Screwdriver

- Chrome vanadium bits with magnetic tips
- Ergonomic soft grip handle for maximum comfort
- Contains:
4 screwdriver tips: #1 & #2 Phillips and 1/4" & 3/16" Slotted
2 Nutdrivers: 1/4" & 5/16"

11010 - COUNTER DISPLAY

Master: 48 Inner: 6
UPC: 8-02090-11010-8

12010 - CARDED

Master: 96 Inner: 12
UPC: 8-02090-12010-7



High Torque Ratcheting Screwdriver

- 3 way ratcheting action: forward, reverse and lock
- Includes 7 screwdriver bits in convenient bit storage collar
2 Phillips #1 & #2
2 Slotted 3/16 & 1/4"
1 Robertson® R2
2 Star T15 & T20

11014 - COUNTER DISPLAY

Master: 48 Inner: 12
UPC: 8-02090-11014-6



6 in 1 Screw & Nut Driver

- Soft grip comfort handle for maximum grip
- Includes #1 & #2 Phillips, 1/4" & 3/16" Slotted screwdriver tips and 1/4" & 5/16" Nutdrivers

12012 - COUNTER DISPLAY

Master: 72 Inner: 12
UPC: 8-02090-12012-1

32965 - COUNTER DISPLAY

Master: 54 Inner: 9
UPC: 8-02090-32965-4



12" High-Torque Ratcheting Screwdriver

- 3-way reversible ratcheting action
- Extra-Long for confined areas
- Hi-Torque: 250 in/lbs
- S2 Alloy steel bits stored in handle:
3 Phillips - #1, #2, #3, 4 Slotted - 5/32", 3/16", 1/4", 9/32"
2 Star - T15, T20, 1 Square - #2, and
1 Socket Adapter 1/4" hex to 1/4" Dr.

12220 - CARDED

Master: 36 Inner: 6
UPC: 8-02090-12220-0



19 in 1 Ratcheting Screwdriver

- 3-way reversible ratcheting action
- 8 double ended screwdriver bits in most popular sizes and types
- Bit holders double as nut drivers - 3 sizes
- Convenient bit storage in handle

11219 - COUNTER DISPLAY

Master: 36 Inner: 12
UPC: 8-02090-11219-5

12219 - CARDED

Master: 36 Inner: 6
UPC: 8-02090-12219-4



Stubby Gearless Ratchet Driver

- Gearless design for smooth operation
- Stubby design for tight, confined areas
- Forward/Reversible ratcheting design
- Includes 6 popular bits stored in handle

11055 - COUNTER DISPLAY

Master: 48 Inner: 12
UPC: 8-02090-11055-9

32969 - COUNTER DISPLAY

Master: 54 Inner: 9
UPC: 8-02090-32969-2

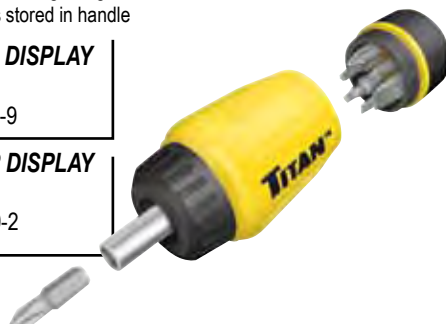

3 pc Square Drive Screwdriver Set

- Chrome vanadium shafts with magnetic tips
- Hex bolsters allow you to loosen stubborn screws with a wrench
- Ergonomic soft grip handle for maximum comfort
- Screwdriver size clearly marked on handle and color coded
- Smooth rounded end cap is easy on your palm
- Contains: R-1, R-2 and R-3

17215 - CARDED

Master: 24 Inner: 6
UPC: 8-02090-17215-1



7 pc Hex Nut Driver Set

- 5" blade length
- Trilobular handle for maximum grip and comfort
- Color-coded for quick and easy size identification
- 7 pieces, sizes include: 1/4, 7/16, 3/8, 11/32, 5/16, 9/32 and 1/2"
- Chrome vanadium steel construction
- Deep drawn socket

16107 - CARDED

Master: 12 Inner: 6
UPC: 8-02090-16107-0



6 pc Tamper Resistant Star Driver Set

- Chrome vanadium shafts with magnetic tips
- Hex bolsters allow you to loosen stubborn screws with a wrench
- Ergonomic soft grip handle for maximum comfort
- Screwdriver size clearly marked on handle and color coded
- Smooth rounded end cap is easy on your palm
- Drilled tips allow use on tamper resistant security screws
- Includes: T-10, T-15, T-20, T-25, T-27 and T-30 drivers

17210 - CARDED

Master: 12 Inner: 6
UPC: 8-02090-17210-6



7 pc INSULATED Electrical Screwdriver Set

- Insulated screwdriver complies with IEC standards
- 1000-volt rating clearly marked
- Ergonomic soft grip handle for maximum comfort
- Sizes include:
3" x #0, 4" x #1 and 4" x #2 Phillips;
3" x 3/16", 4" x 1/8", 5" x 3/8" and 6" x 1/4" Slotted

17237 - CARDED

Master: 12 Inner: 6
UPC: 8-02090-17237-3



4 pc Jumbo BOLSTERED Pick & Hook Set

- Chrome-vanadium steel shafts
- Comfortable TPR grips
- 4 picks: Straight, 90 degree, Offset and Curved

17224 - CARDED

Master: 18 Inner: 6
UPC: 8-02090-17224-3



Hose & Cotter Pin Remover

- Angled, pointed tip allows for the separating of hoses from fittings and clamps.
- Unique angle provides leverage to remove cotter pins from most environments.
- For use on most hoses and cotter pins

15046 - CARDED

Master: 72 Inner: 12
UPC: 8-02090-15046-3



12 pc Precision Pick and Screwdriver Set

- Chrome plated chrome-vanadium steel shafts
- Comfortable TPR grips
- Handy nylon storage pouch
- 4 Utility picks: Straight, 90°, 1/4" radius and 1/8" radius
- 4 Screwdrivers: #000 and #00 Phillips; 3/32" and 1/8" slotted
- 4 Star drivers: T5, T7, T8 and T10

17612 - CARDED

Master: 72 Inner: 12
UPC: 8-02090-16503-0



4 pc Pliers Set with TPR Grips

- Includes 4 pliers: 7" Lineman, 6" Diagonal, 6" Slip-Joint and 6" Long Nose Pliers
- Oversized ergonomic grips provide extra comfort and reduced hand fatigue
- Chrome-vanadium steel construction

18404 - CARDED

Master: 18 Inner: 6
UPC: 8-02090-18404-8



5 pc Precision Pliers Set with Case

- Double dipped cushion grip handles for comfort
- Drop forged high carbon steel with hardened cutting edges
- Rust resistant finish
- Includes: 4-3/4" diagonal cutters, 4-3/4" flat nose, 4-3/4" needle nose, 4-3/4" line-man pliers & 4-3/4" end nipper
- Lifetime Warranty

18405 - CARDED

Master: 24 Inner: 6
UPC: 8-02090-18405-5



3 pc Curved Jaw Locking Pliers Set

- Oversized ergonomic grips for extra comfort and durability
- Chrome-vanadium steel construction
- Adjustable locking action
- Includes: 5", 7" and 10" curved jaw locking pliers

18450 - CARDED

Master: 12 Inner: 6
UPC: 8-02090-18450-5



5 pc Locking Pliers Set

- Oversized ergonomic grips for extra comfort and durability
- Chrome-vanadium steel construction
- Adjustable locking action
- Includes: 5", 7" & 10" curved jaw, and 6" & 8" long nose locking pliers

18453 - CARDED

Master: 12 Inner: 6
UPC: 8-02090-18453-6



Lock Grip Pliers

- Oversized ergonomic grips - CR-V steel construction
- Adjustable locking action

5" LOCK GRIP PLIERS

11450 - CARDED

Master: 48 Inner: 12
UPC: 8-02090-11450-2



8" LOCK GRIP PLIERS

11453 - CARDED

Master: 48 Inner: 12
UPC: 8-02090-11453-3



6" LOCK GRIP LONG NOSE PLIERS

11454 - CARDED

Master: 48 Inner: 12
UPC: 8-02090-11454-0

7.5" Compound Lever-Action Diagonal Pliers

- Compound lever-action handles for more cutting & gripping power
- Double dipped cushion grip handles for comfort
- Spring loaded handles reduce hand fatigue
- Heat-treated high carbon steel

11412 - BULK in 12 PACK COUNTER DISPLAY

Master: 48 Inner: 12
UPC: 8-02090-11412-0



50 pc Depth Setter

- Unique design causes bit to disengage with screw at correct depth - perfectly flush & not too deep
- #2 Phillips
- 1 inch bit
- 1/4" shank

16025 - FISHBOWL

Master: 10 Inner: 1
UPC: 8-02090-16025-7



50 pc Depth Setter

- Unique design causes bit to disengage with screw at correct depth - perfectly flush & not too deep
- R2 Square
- 1 inch bit
- 1/4" shank

16026 - FISHBOWL

Master: 10 Inner: 1
UPC: 8-02090-16026-4



2 pc Drywall Screw Bit Set

- Unique collar design causes bit to disengage with screw at correct depth - perfectly flush & not too deep
- #2 Phillips bits
- 1/4" hex shank

16250 - CARDED

Master: 96 Inner: 24
UPC: 8-02090-16250-3



22 pc Magnetic Bit Holder

- Spinning finger grip for increased control
- 12 times stronger magnet than standard bit holder
- Easy one-hand operation
- Retract collar to install or remove bits
- 3,000 RPM max
- Use with insert bits only

16021 - FISHBOWL

Master: 10 Inner: 1
UPC: 8-02090-16021-9

Magnetic Bit Holder



64 pc Deluxe Power Screwdriver Bit Set

- Quick Release magnetic bit holder
- 48 One-inch bits: Phillips, Slotted, Pozidrive, Hex, Star and Tamper Resistant Star
- 15 Two-inch bits: Phillips, Slotted, Pozidrive and Star
- Easy-access flip-up bit racks
- Deluxe storage case

16064 - CARDED

Master: 10 Inner: 5
UPC: 8-02090-16064-6



61 pc Screwdriver Bit Set

- Includes: 2-1/2" magnetic bit holder
- 6 Phillips - 5 Slotted - 13 Star
- 6 Pozidrive - 12 Hex - 5 Spanner
- 7 Tamper Resistant Star
- 6 Tamper Resistant Hex
- Convenient storage case

16061 - COUNTER DISPLAY

Master: 36 Inner: 4
UPC: 8-02090-16061-5



33 pc Security Bit Set

- Includes:
- 2-1/2" magnet bit holders - #4, #6, #8, and #10 spanner bits
 - #6, #8, and #10 TORQ bits - #1, #2, #3, and #4 Triwing bits
 - T8, T10, T15, T20, T25, T30, & T40 Tamper Star Bits
 - 2, 2.5, 3, 4.5, & 6mm Metric Tamper Resistant Hex Bits
 - 5/64, 3/32, 7/64, 1/8, 9/64, and 5/32" SAE Tamper Resistant Hex Bits

16032 - CARDED

Master: 48 Inner: 12
UPC: 8-02090-16032-5

32964 - DISPLAY

Master: 36 Inner: 6
UPC: 8-02090-32964-7



148 pc Master Bit Set

- The most popular, and hard to find bits for many different applications
- Contains Phillips, slotted, square drive, Star(r), Pozi-drive, inch and metric Hex, tamper resistant Star(r), tamper resistant hex, clutch drive, spline drive, spanner, three wing and four wing drives
- 3-1/2" Magnetic bit holder
- Quick Release bit holder
- 1/4" drive socket adaptor
- Injection molded storage case

16148 - BOXED

Master: 12 Inner: 6
UPC: 8-02090-16148-6



Quick Release Bit Holder Extensions

- Extended driver for hard to reach areas
- Auto locking drive
- Locking, magnetic, low profile, quick release bit holder

6" EXTENSION

16006 - HANG TAB in COUNTER DISPLAY

Master: 120 Inner: 20
UPC: 8-02090-16006-6

12" EXTENSION

16012 - HANG TAB in COUNTER DISPLAY

Master: 48 Inner: 6
UPC: 8-02090-16012-7

18" EXTENSION

16018 - HANG TAB in COUNTER DISPLAY

Master: 48 Inner: 6
UPC: 8-02090-16018-9



20 pc Quick Release Extension Driver & Drill Bit Set

- S2 Alloy bits with Chrome Vanadium sockets
- Includes: 6, 12 & 18" extensions, 3, 4, 5, 6, 7, 8, 9 & 10mm bits

16010 - CARDED

Master: 6 Inner: 1
UPC: 8-02090-16010-3



31 pc High Performance Color Coded Bit Set

- Arched, folding storage case for easy access
- Anodized, color coded bits
- Quick Release bit holder
- Bits include: Tamper Resistant Star, Phillips, Slotted, Square, Spanner and Tamper Resistant MM Hex

16034 - CARDED

Master: 48 Inner: 12
UPC: 8-02090-16034-9



25 pc 2-1/4" Quick Release Magnetic Bit Holder

- Auto locking drive
- Locking, magnetic, low profile, Quick Release bit holder

16020 - FISHBOWL

Master: 10 Inner: 1
UPC: 8-02090-16020-2



Magnetic Bit Holder

- Spinning finger grip for increased control
- 12 times stronger magnet than standard bit holder
- Easy one-hand operation
- Retract collar to install or remove bits
- 3,000 RPM max
- Use with insert bits only
- Includes bit holder with 6 bits: #1 & #3 Phillips, S1 & S2 Square Drive and 6-8 & 8-10 Slotted

16008 - CARDED

Master: 48 Inner: 6
UPC: 8-02090-16008-0



Flexible Extension Bit Holder

- Locking, magnetic, quick release bit holder
- 12x stronger magnet than standard bit holder
- Extended flexible driver for hard to reach areas
- Compress silver ring to insert and remove bit
- Designed to flex and hold at various angles
- For use with hand or power tool driver

16004 - CARDED

Master: 36 Inner: 6
UPC: 8-02090-16004-2



48 pc Quick-Disconnect Drill Bit & Power Bit Set with Portable Bit Cases

- Countersink, Magnetic Extension,
- Quick Disconnect, Power Nut Drivers
- 1" Screwdriver bits - Phillips, Slotted and Hex
- 2" Quick-Disconnect Bits - Star, Phillips, Slotted & Hex
- Quick-Disconnect High Speed Drill Bits

16048 - CARDED

Master: 12 Inner: 6

UPC: 8-02090-16048-6



22 pc Titanium-Coated HSS Drill Bit Set

- Titanium nitride coating extends the life of the bit up to 6xs longer than standard hss drill bits
- Contains: 1/16, 5/64, 3/32, 7/64, 1/8, 9/64, 5/32, 11/64, 3/16, 13/64, 7/32, 15/64, 1/4, 17/64, 9/32, 19/64, 5/16, 21/64, 11/32, 23/64, 3/8"
- Ships in plastic storage case

11006 - COUNTER DISPLAY

Master: 36 Inner: 6

UPC: 8-02090-11006-1



10 pc Reverse Drill & Screw Extractor Set

- 5 Reverse Drill Bits, sizes 5/64, 7/64, 5/32, 1/4, 19/64"
- 5 Screw Extractors, sizes #1 - 5
- Includes sturdy metal storage box

16013 - CARDED

Master: 48 Inner: 12

UPC: 8-02090-16013-4



32963 - COUNTER DISPLAY

Master: 30 Inner: 5

UPC: 8-02090-32963-0

3 pc Step Drill Bit Set

- High speed steel with titanium finish
- Drill multiple sizes with each bit
- 28 hole sizes in 3 bits:
Bit one: 13 sizes from 1/8" to 1/2"
Bit two: 6 sizes from 3/16" to 1/2"
Bit three: 9 sizes from 1/4" to 3/4"

16503 - CARDED

Master: 72 Inner: 12

UPC: 8-02090-16503-0

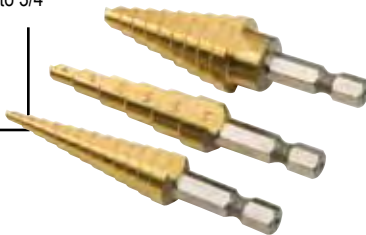

Titanium-Coated HSS #1 Step Drill Bit - 1/8" - 1/2"

- Titanium coating extends life of the bit
- Drill 13 different sizes with one bit:
1/8, 5/32, 3/16, 7/32, 1/4, 9/32, 5/16, 11/32, 3/8, 13/32, 7/16, 15/32 and 1/2"

16501 - CARDED

Master: 144 Inner: 24

UPC: 8-02090-16501-6



3 pc Damaged Screw Remover Set

- Removes damaged Phillips, Slotted, Star and Square screws
- Hardened steel bits for secure bite on fasteners
- 1/4" hex shank fits drills, sockets and screwdrivers
- Sizes #1, #2 and #3 screw removers
- Protective storage case

16014 - CARDED

Master: 48 Inner: 12

UPC: 8-02090-16014-1

11214 - COUNTER DISPLAY

Master: 48 Inner: 12

UPC: 8-02090-11214-0



2 pc Power Screwdriver Bit Sets

- 2" length x 1/4" hex drive - S2 Alloy Steel
- Cold forged for 3-times-longer bit life

#2 Phillips

16210 - CARDED

Master: 400 Inner: 20 UPC: 8-02090-16210-7

#2 Square

16220 - CARDED

Master: 400 Inner: 20 UPC: 8-02090-16220-6

1/4" Slotted

16230 - CARDED

Master: 400 Inner: 20 UPC: 8-02090-16230-5



2 pc Long Power Screwdriver Bit Sets

- 6" length x 1/4" hex drive - S2 Alloy Steel - Cold forged for 3-times-longer bit life

#2 Phillips

16211 - CARDED

Master: 200 Inner: 50 UPC: 8-02090-16211-4

#2 Square

16221 - CARDED

Master: 200 Inner: 50 UPC: 8-02090-16221-3

1/4" Slotted

16231 - CARDED

Master: 200 Inner: 50
UPC: 8-02090-16231-2



2 pc Fits-All-Phillips™ Bit Set

- Patented, precision ground tip fits common Phillips screws: #0, #1, #2, #3 and larger
- 2-1/2" length x 1/4" hex drive
- Chrome plated S2 Alloy Steel

16240 - CARDED

Master: 96 Inner: 24
UPC: 8-02090-16240-4

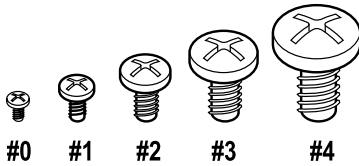

... And larger

20 pc Screwdriver Packs

- 1" Length x 1/4" hex drive
- S2 Alloy Steel
- Ships in 6 pack, gravity feed display

#2 Phillips

16260 - DISPLAY

Master: 96 Inner: 24
UPC: 8-02090-16260-2

#2 Square

16270 - DISPLAY

Master: 96 Inner: 24
UPC: 8-02090-16270-1



3 pc Magnetic Nut Setter Set

- Magnetic nut driver
- Chrome vanadium construction
- 3" x 1/4" shank
- Sizes include: 1/4", 5/16", 3/8"

16103 - CARDED

Master: 75 Inner: 15
UPC: 8-02090-16103-2

32977 - DISPLAY

Master: 36 Inner: 6
UPC: 8-02090-32977-7



3 pc Long Shank Magnetic Nut Setter Set

- Magnetic nut driver
- Chrome vanadium construction
- 6" x 1/4" shank
- Sizes include: 1/4", 5/16", 3/8"

16106 - CARDED

Master: 75 Inner: 15
UPC: 8-02090-16106-3



Single Magnet Parts Tray

- 5-7/8" Round stainless steel magnetic parts tray
- Single magnet features a non-marring vinyl magnetic base
- Great for securing small parts, fasteners, any many other materials
- Will stick to any ferrous metal surface; even works upside down!

21264 - DISPLAY BOX

Master: 48 Inner: 6
UPC: 8-02090-21264-2



Double Magnet Parts Tray

- 5-3/8" x 9-3/8" Rectangular stainless steel magnetic parts tray
- Twin magnets feature a non-marring vinyl magnetic base
- Great for securing small parts, fasteners, any many other materials
- Will stick to any ferrous metal surface; even works upside down!

21265 - DISPLAY BOX

Master: 24 Inner: 6
UPC: 8-02090-21265-9



Mini Magnetic Parts Tray

- 4-1/4" Stainless steel dish
- Perfect for holding small parts, hardware and fasteners in place
- Sticks to any ferrous metal surface - it even works upside down!
- Rubber covered magnetic base prevents scratching

11061 - COUNTER DISPLAY

Master: 100 Inner: 10
UPC: 8-02090-11061-0



32962 - COUNTER DISPLAY

Master: 36 Inner: 6
UPC: 8-02090-32962-3

3 pc Utility Tool Set

- 3 piece set includes: 4-1/4" mini magnetic tray, telescoping inspection mirror and telescoping magnetic pickup tool

11065 - CARDED

Master: 36 Inner: 6
UPC: 8-02090-11065-8



5 lb. Telescoping Magnetic Pick-Up Tool

- 5 lb. Magnet with shielded sides for targeted pick-ups
- 3/4" Diameter head
- Telescopes from 6-1/2" to 33"
- Ideal for retrieving dropped parts, fasteners and tools
- Comfortable textured cushion grip

11663 - COUNTER DISPLAY

Master: 120 Inner: 20
UPC: 8-02090-11663-6



3 lb. Magnetic Retriever

- Extends to 25"
- 7/16" Diameter head
- Handy pocket clip
- Ships in counter display

11763 - COUNTER DISPLAY

Master: 120 Inner: 20
UPC: 8-02090-11763-3

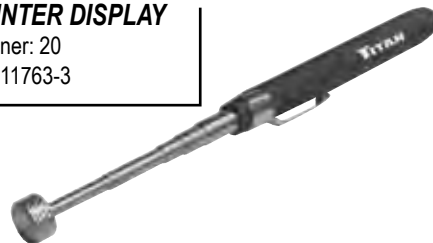

24" Flexible Claw Retriever

- 4-finger claw design opens up to 1" wide
- 24" flexible shaft holds shape to reach around obstacles
- TPR handle grip with rounded knob for comfort
- Professional Grade!

11162 - CARDED

Master: 48 Inner: 12
UPC: 8-02090-11162-4



24" Flexible Magnetic Retriever

- Powerful 3 lb. magnet with shielded sides for targeted pick-ups
- 24" flexible shaft holds shape to reach around obstacles
- TPR handle grip with rounded knob for comfort
- Professional Grade!

11163 - CARDED

Master: 48 Inner: 12
UPC: 8-02090-11163-1



6 pc Punch & Chisel Set

- Heat-treated high carbon steel
- Cushion grip handles
- Includes 5 pin punches and 1 cold chisel
- Packed in handy storage tray

17106 - CARDED

Master: 30 Inner: 10
UPC: 8-02090-17106-2



Hori Hori Gardening Tool

- Great for transplanting, weeding, cultivating, grubbing, breaking tough soil, prying and many other uses
- Sharp stainless steel blade ideal for precision cutting and removal of deep roots
- Serrated edges help rid area of unwanted roots
- Black vinyl sheath with belt holder

11094 - COUNTER DISPLAY

Master: 36 Inner: 6
UPC: 8-02090-11094-8



Power Spray Hose Nozzle

- Firefighter style nozzle attaches to any garden hose
- Twist nozzle for 3 spray patterns:
Gentle shower, Medium power spray or High power jet
- Soft comfort grip handle protects hands from hot or cold water

11090 - COUNTER DISPLAY

Master: 48 Inner: 6
UPC: 8-02090-11090-0



Adjustable Water Spray Nozzle

- Attaches to any garden hose
- Twist action adjustable valve for variable water streams
- Durable rubber material
- Ships in 6 piece counter display

11091 - COUNTER DISPLAY

Master: 48 Inner: 6
UPC: 8-02090-11091-7



Magnifying Glass

- 2.2x magnification
- Non-distorting optical grade glass lens
- Comfortable TPR rubber grip handle
- TPR rubber framing for extra protection
- Lens diameter 2-7/8"
- 7-1/4" overall length

15038 - COUNTER DISPLAY

Master: 72 Inner: 9
UPC: 8-02090-15038-8

32971 - COUNTER DISPLAY

Master: 48 Inner: 8
UPC: 8-02090-32971-5



Internal Pipe Wrenches

- For internal diameter applications
- Remove broken, threaded ends of pipe, pipe plugs & fittings

3/8" WRENCH

11483 - CARDED
Master: 100 Inner: 10
UPC: 8-02090-11483-0

1/2" WRENCH

11484 - CARDED
Master: 100 Inner: 10
UPC: 8-02090-11484-7

3/4" WRENCH

11485 - CARDED
Master: 100 Inner: 10
UPC: 8-02090-11485-4

3 pc WRENCH SET - 3/8", 1/2" AND 3/4"

11498 - CARDED
Master: 40 Inner: 10
UPC: 8-02090-11498-4



12" Basin Wrench

- Steel forged milled jaw
- Sliding T-handle for work in confined spaces
- Head pivots up to 90 degree
- Self Adjusting Jaws

11499 - CARDED

Master: 40 Inner: 10
UPC: 8-02090-11499-1

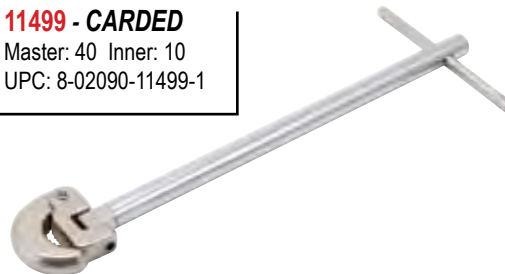

1/2" Dr. Hot Water Heater Fitting Socket

- 1/2" Drive
- 6 point, 1-1/2" deep

32948 - HANG TAB

Master: 48 Inner: 6
UPC: 8-02090-32948-7

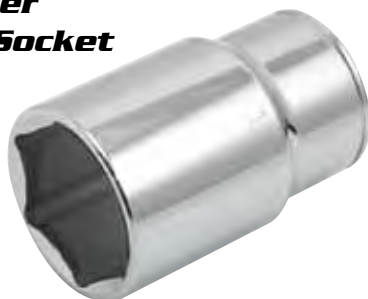

Mini Tubing Cutter

- Cuts 1/8" to 7/8" diameter tubing
- Change out wheels with only a screwdriver
- Includes .75" dia. blade for copper & brass tubing
- Replacement blades available:
Titan #11492 for copper/brass tubing or
Titan #11493 for stainless steel tubing

11490 - CARDED

Master: 100 Inner: 10
UPC: 8-02090-11490-8



1/8" - 1-1/8" Chrome Tubing Cutter

- Cuts 1/8" - 1 1/8"
- Roller tracking system keeps pipe from threading
- Full stop feed system prevents wheels and rollers from coming into contact
- Comes with 1 blade .75" diameter (19mm)
- Cuts copper & brass tube
- Replacement blade, Titan part 11492 for brass & copper tubing & 11493 for stainless steel tubing

11494 - CARDED

Master: 48 Inner: 6
UPC: 8-02090-11494-6



Tubing Cutter

- Cuts 1/8" to 1-3/8" diameter tubing
- Four-roller tracking system keeps tubing from threading
- Full stop feed system prevents wheels and rollers from coming into contact
- Change out wheels with only a screwdriver
- Includes .75" dia. blade for copper & brass tubing
- Replacement blades available:
Titan #11492 for copper/brass tubing or
Titan #11493 for stainless steel tubing

11491 - CARDED

Master: 36 Inner: 6
UPC: 8-02090-11491-5



Replacement Tubing Cutter Blades

- Replacement blades for Titan 11490 and 11491

For copper/brass tubing

11492 - CARDED

Master: 100 Inner: 1
UPC: 8-02090-11492-2

For stainless steel tubing

11493 - CARDED

Master: 100 Inner: 1
UPC: 8-02090-11493-9

Professional Tubing Cutter

- Cuts 1/8" to 1-5/8" diameter tubing
- Four-roller tracking system keeps tubing from threading
- Full stop feed system keeps wheels & rollers from coming into contact
- Change out wheels with only a screwdriver
- Cuts copper, brass and aluminum tube and thin-wall conduit
- Use replacement cutting blades: 11492: Copper / brass tubing 11493: Stainless steel tubing

11496 - CARDED

Master: 36 Inner: 6
UPC: 8-02090-11496-0



1/4"-2-5/8" Professional Tubing Cutter

- Cuts 1/8" - 2-5/8" - Zip-action opening
- Roller tracking system keeps pipe from threading
- Full stop feed system prevents wheels and rollers from coming into contact
- Change out wheels with only a screwdriver
- Comes with 1 blade .75" diameter (19mm)
- Cuts copper, brass & aluminum tube and thin-wall conduit
- Replacement blade, Titan part 11492 for brass & copper tubing & 11493 for stainless steel tubing

11497 - CARDED

Master: 12 Inner: 1
UPC: 8-02090-11497-7



Tube Bender

- Bends copper, brass and other soft thin wall tubing
- 1/8" to 1/2" (3mm to 13mm) O.D. Tubing

11486 - CARDED

Master: 72 Inner: 12
UPC: 8-02090-11486-1



Tube Bender

- For copper, brass and other types of soft metal thin wall tubing
- For tubing up to 5/16 (8mm) O.D.

11487 - CARDED

Master: 144 Inner: 24
UPC: 8-02090-11487-8



Tube Bending Pliers

- Bends Copper, Brass and other soft thin walled tubing
- For 3/16, 1/4 5/16 and 3/8 tubing

11488 - CARDED

Master: 24 Inner: 12
UPC: 8-02090-11488-5



180 Degree Tube Bender

- Makes short, smooth radius bends up to 180 degrees
- Calibration gauge to indicate angle of bend
- For copper, aluminum and thin wall tubing
- 3/8" maximum bending capacity
- 180 degree maximum bending capacity
- For 1/8, 3/16, 1/4" O.D. Tubing

11489 - CARDED

Master: 24 Inner: 12
UPC: 8-02090-11489-2

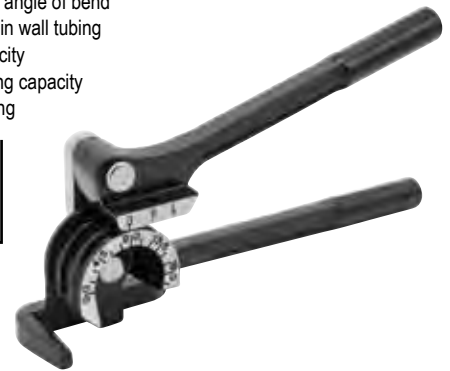

4 in 1 Combination Internal / External Snap Ring Plier Set

- For use with both internal and external snap rings
- Includes 4 interchangeable tips: 2 straight, 1-90 deg. and 1-45 deg.
- Comfort grip handles
- Effective range: 10 - 50 mm (3/8" x 2")

18403 - CARDED

Master: 60 Inner: 20
UPC: 8-02090-18403-1



Wire Stripper

- Strips & cuts solid (AWG 8-20) & stranded wire (8-22ga)
- Narrow, serrated plier nose to pull, loop & bend wire
- Solidly crimps both insulated and non-insulated terminals along with 7mm to 9mm ignition terminals

11478 - CARDED

Master: 60 Inner: 10
UPC: 8-02090-11478-6

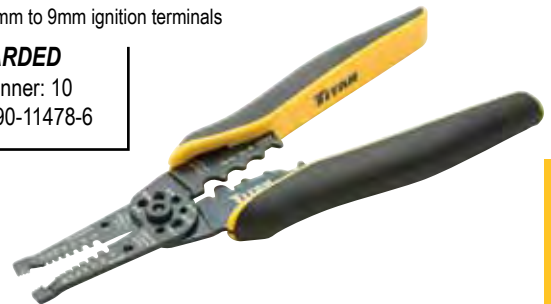

Self-Adjusting Wire Stripper

- Automatically adjusts to strip 24 - 10 AWG wire and cable
- Crimps 22 - 10 AWG insulated and non-insulated wire terminals
- Crimps 7 - 8mm ignition terminals
- Wire cutter
- Comfortable TPR hand grips

11475 - CARDED

Master: 60 Inner: 10
UPC: 8-02090-11475-5



Hex and Star Bit Sockets Toolboard

- Chrome vanadium sockets with S-2 Alloy bits

T-10 1/4" TR Star Bit	15410	Qty: 2	14mm 1/2" Hex Bit	15614	Qty: 2
T-15 1/4" TR Star Bit	15415	Qty: 2	15mm 1/2" Hex Bit	15615	Qty: 2
T-20 1/4" TR Star Bit	15420	Qty: 2	16mm 1/2" Hex Bit	15616	Qty: 2
T-25 1/4" TR Star Bit	15425	Qty: 2	17mm 1/2" Hex Bit	15617	Qty: 2
T-27 1/4" TR Star Bit	15427	Qty: 2	18mm 1/2" Hex Bit	15618	Qty: 1
T-30 1/4" TR Star Bit	15430	Qty: 2	19mm 1/2" Hex Bit	15619	Qty: 1
T-40 3/8" TR Star Bit	15440	Qty: 2	21mm 1/2" Hex Bit	15621	Qty: 1
T-45 3/8" TR Star Bit	15445	Qty: 2	22mm 1/2" Hex Bit	15622	Qty: 1
T-47 3/8" TR Star Bit	15447	Qty: 2	5/64" 1/4" Hex Bit	15650	Qty: 2
T-50 3/8" TR Star Bit	15450	Qty: 2	3/32" 1/4" Hex Bit	15651	Qty: 2
T-55 3/8" TR Star Bit	15455	Qty: 2	7/64" 1/4" Hex Bit	15652	Qty: 2
T-60 1/2" TR Star Bit	15460	Qty: 2	1/8" 1/4" Hex Bit	15653	Qty: 2
T-10 1/4" Star Bit	15510	Qty: 2	9/64" 1/4" Hex Bit	15654	Qty: 2
T-15 1/4" Star Bit	15515	Qty: 2	5/32" 1/4" Hex Bit	15655	Qty: 2
T-20 1/4" Star Bit	15520	Qty: 2	3/16" 3/8" Hex Bit	15656	Qty: 2
T-25 1/4" Star Bit	15525	Qty: 2	7/32" 3/8" Hex Bit	15657	Qty: 2
T-27 1/4" Star Bit	15527	Qty: 2	1/4" 3/8" Hex Bit	15658	Qty: 2
T-30 1/4" Star Bit	15530	Qty: 2	5/16" 3/8" Hex Bit	15659	Qty: 2
T-40 3/8" Star Bit	15540	Qty: 2	3/8" 3/8" Hex Bit	15660	Qty: 2
T-45 3/8" Star Bit	15545	Qty: 2	7/16" 1/2" Hex Bit	15661	Qty: 2
T-47 3/8" Star Bit	15547	Qty: 2	1/2" 1/2" Hex Bit	15662	Qty: 2
T-50 3/8" Star Bit	15550	Qty: 2	9/16" 1/2" Hex Bit	15663	Qty: 2
T-55 3/8" Star Bit	15555	Qty: 2	5/8" 1/2" Hex Bit	15664	Qty: 2
T-60 1/2" Star Bit	15560	Qty: 2	11/16" 1/2" Hex Bit	15665	Qty: 2
T-70 1/2" Star Bit	15570	Qty: 2	3/4" 1/2" Hex Bit	15666	Qty: 2
2.5mm 1/4" Hex Bit	15600	Qty: 2	13/16" 1/2" Hex Bit	15667	Qty: 2
5.5mm 1/4" Hex Bit	15601	Qty: 2	7/8" 1/2" Hex Bit	15668	Qty: 2
2mm 1/4" Hex Bit	15602	Qty: 2	15/16" 1/2" Hex Bit	15669	Qty: 2
3mm 1/4" Hex Bit	15603	Qty: 2	1" 1/2" Hex Bit	15670	Qty: 2
4mm 1/4" Hex Bit	15604	Qty: 2	24"x1" Cross Bar	98040	Qty: 5
5mm 1/4" Hex Bit	15605	Qty: 2	2" Steel Peg Hooks	98043	Qty: 80
6mm 3/8" Hex Bit	15606	Qty: 2	Plastic Disp. Board	98044	Qty: 1
7mm 3/8" Hex Bit	15607	Qty: 2	Header Artwork	98108-1	Qty: 1
8mm 3/8" Hex Bit	15608	Qty: 2	Re-order Strip Set	98108-2	Qty: 1
9mm 3/8" Hex Bit	15609	Qty: 2			
10mm 3/8" Hex Bit	15610	Qty: 2			
11mm 1/2" Hex Bit	15611	Qty: 2			
12mm 1/2" Hex Bit	15612	Qty: 2			
13mm 1/2" Hex Bit	15613	Qty: 2			

98108 - TOOLBOARD

Master: 1 Inner: 1

UPC: 8-02090-98108-1



Hex and Star Bit Socket Sets Toolboard

- Chrome vanadium sockets with S-2 Alloy bits

12 pc Tamper Resistant Star Bit Set	16121	Qty: 1
13 pc Star Bit Socket Set	16122	Qty: 1
13 pc SAE Hex Bit Socket Set	16123	Qty: 1
13 pc Metric Hex Bit Socket Set	16124	Qty: 1
9 pc 3/8" Star Socket Bit Set	16129	Qty: 2
6 pc SAE Large Hex Bit Socket Set	16130	Qty: 1
7 pc Metric Large Hex Bit Socket Set	16131	Qty: 1
8 pc SAE & Metric Lrg Hex Bit Skt Set	16132	Qty: 1
10 pc 3/8" SAE Hex Bit Socket Set	16133	Qty: 2
10 pc 3/8" Metric Hex Bit Socket Set	16134	Qty: 2
13 pc E-Socket Set	17403	Qty: 1
24"x1" Cross Bar	98040	Qty: 1
24"x3" Cross Bar	98041	Qty: 1
24"x4.5" Cross Bar	98042	Qty: 1
2" Steel Peg Hooks	98043	Qty: 17
Plastic Disp. Board	98044	Qty: 1
Header Artwork	98109-1	Qty: 1
Re-order Strip Set	98109-2	Qty: 1

98109 - TOOLBOARD

Master: 1 Inner: 1

UPC: 8-02090-98109-8



SAE Ratcheting Combination Wrench Toolboard

- Most common SAE sizes - 72 fine-tooth ratchet design for fast performance
 - Less than 5 degree sweep for use in tight spots - Chrome vanadium steel

1/4" Wrench	12601	Qty: 1	1-1/4" Wrench	12616	Qty: 1
5/16" Wrench	12602	Qty: 1	7 pc SAE Ratcheting Combo.		
3/8" Wrench	12603	Qty: 1	Wrench Set	17350	Qty: 1
7/16" Wrench	12604	Qty: 1	7 pc SAE Ratcheting Combo.		
1/2" Wrench	12605	Qty: 1	Wrench Set	17351	Qty: 1
9/16" Wrench	12606	Qty: 1	13 pc SAE Ratcheting Combo.		
5/8" Wrench	12607	Qty: 1	Wrench Set	17354	Qty: 1
11/16" Wrench	12608	Qty: 1	24"x1" Cross Bar	98040	Qty: 1
3/4" Wrench	12609	Qty: 1	24"x3" Cross Bar	98041	Qty: 1
13/16" Wrench	12610	Qty: 1	24"x4.5" Cross Bar	98042	Qty: 1
7/8" Wrench	12611	Qty: 1	2" Steel Peg Hooks	98043	Qty: 25
15/16" Wrench	12612	Qty: 1	Plastic Disp. Board	98044	Qty: 1
1" Wrench	12613	Qty: 1	Header Artwork	98101-1	Qty: 1
1-1/16" Wrench	12614	Qty: 1	Re-order Strip Set	98101-2	Qty: 1
1-1/8" Wrench	12615	Qty: 1			

98101 - TOOLBOARD

Master: 1 Inner: 1
 UPC: 8-02090-98101-2



Metric Ratcheting Combination Wrench Toolboard

- Most common Metric sizes - 72 fine-tooth ratchet design for fast performance
 - Less than 5 degree sweep for use in tight spots - Chrome vanadium steel

6mm Wrench	12506	Qty: 1	22mm Wrench	12522	Qty: 1
7mm Wrench	12507	Qty: 1	24mm Wrench	12524	Qty: 1
8mm Wrench	12508	Qty: 1	25mm Wrench	12525	Qty: 1
9mm Wrench	12509	Qty: 1	27mm Wrench	12526	Qty: 1
10mm Wrench	12510	Qty: 1	30mm Wrench	12527	Qty: 1
11mm Wrench	12511	Qty: 1	32mm Wrench	12528	Qty: 1
12mm Wrench	12512	Qty: 1	34mm Wrench	12529	Qty: 1
13mm Wrench	12513	Qty: 1	12 pc Ratcheting Metric Gear		
14mm Wrench	12514	Qty: 1	Wrench Set	17355	Qty: 1
15mm Wrench	12515	Qty: 1	24"x1" Cross Bar	98040	Qty: 1
16mm Wrench	12516	Qty: 1	24"x3" Cross Bar	98041	Qty: 1
17mm Wrench	12517	Qty: 1	24"x4.5" Cross Bar	98042	Qty: 1
18mm Wrench	12518	Qty: 1	2" Steel Peg Hooks	98043	Qty: 25
19mm Wrench	12519	Qty: 1	Plastic Disp. Board	98044	Qty: 1
20mm Wrench	12520	Qty: 1	Header Artwork	98100-1	Qty: 1
21mm Wrench	12521	Qty: 1	Re-order Strip Set	98100-2	Qty: 1

98100 - TOOLBOARD

Master: 1 Inner: 1
 UPC: 8-02090-98100-5



1/4" Micro Ratchets

- Great for use in today's increasingly compact cars
- Chrome plated polish helps prevent corrosion and rust
- Chrome Vanadium - 60 Teeth
- Ratchet: 43 ft/lbs of torque - Bit Driver: 43ft/lbs of torque
- Ideal for confined under-dash and engine compartment spaces

11202 Offset, 2 pc Set - CARDED

Master: 48 Inner: 6

UPC: 8-02090-11202-7



11203 Straight, 2 pc Set - CARDED

Master: 48 Inner: 6

UPC: 8-02090-11203-4



1/4" Dr. Offset Micro Ratchet

- Reversible
- 60 tooth gearhead design
- High torque
- Small 3" size with offset handle gets into the most confined areas

11204 - HANG TAB

Master: 48 Inner: 6

UPC: 8-02090-11204 -1

32966 - DISPLAY

Master: 54 Inner: 9

UPC: 8-02090-32966 -1



1/4" Shank Offset Micro Bit Driver With Bits

- Great for use in today's increasingly compact cars.
- Ideal for confined under-dash and engine compartment spaces
- Chrome plated polish helps prevent corrosion and rust
- 1/4" Dr. - Chrome Vanadium
- Contains: ph1, ph2, ph2, Slotted 1/4", Slotted 3/16" T-15, T-20, R1, R2
- Bit Driver: 43ft/lbs of torque

11205 - CARDED

Master: 48 Inner: 6

UPC: 8-02090-11205-8



1/4" Shank Offset Micro Bit Driver

- Includes (1) Hex Bit Ratchet and (1) #2 Phillip Bit
- Great for use in today's increasingly compact cars
- Ideal for under-dash and engine compartment spaces
- Chrome plated polish helps prevent corrosion &
- CRV construction - 60 tooth gearhead design
- High torque - Reversible - Offset
- 12pc Counter Display

11207 - DISPLAY

Master: 96 Inner: 12

UPC: 8-02090-11207-2



Combination Wrench Sets

- Full Polish
- CRV Construction
- SAE sizes include: 3/8, 7/16, 1/2, 9/16, 5/8, 11/16, 3/4, 13/16, 7/8, 15/16, 1, 1-1/16, 1-1/8, & 1-1/4"
- MM sizes include: 10-19, 21, 22, 24, 25, 30 & 32mm

17308 14 pc SAE - POUCH

Master: 4 Inner: 1

UPC: 8-02090-17309-7

17309 16 pc MM - POUCH

Master: 4 Inner: 1

UPC: 8-02090-17309-7



3 pc Finger Driver Set

- Knurled for easier grip
- Interchangeable Bits
- Size includes: (1) 1/4" Slotted Screwdriver Bit, (1) #2 Phillips, Screwdriver Bit, (1) 1/4" Socket Adaptor

32958 - CARDED/DISPLAY

Master: 36 Inner: 6

UPC: 8-02090-32958-6



7 pc Universal Drive Wrench Set

- 15 Degree angled head for increased clearance
- Easily identifiable sizes
- Spline Drive for use on multiple fasteners
- Metric sizes include: 8, 10, 11, 13, 14, 15, 17 mm
- SAE sizes include: 5/16, 3/8, 7/16, 1/2, 9/16, 5/8, & 11/16"

17313 Metric - HANGTAB

Master: 12 Inner: 6

UPC: 8-02090-17313-4

17314 SAE - HANGTAB

Master: 12 Inner: 6

UPC: 8-02090-17314-1

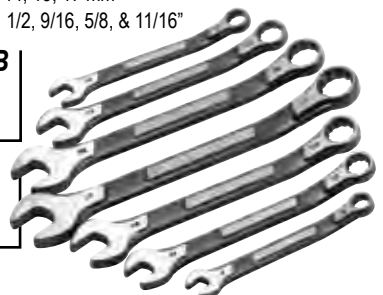

8 pc Lateral Drive Wrench Sets

- Ergonomic handle design
- Full Polish
- SAE sizes include: 3/4, 11/16, 5/8, 9/16, 1/2, 7/16, 3/8 and 5/16"
- Metric sizes include: 19, 18, 17, 16, 15, 14, 13, 12, 11, 10, 9 and 8mm

17316 SAE - FOAM TRAY

Master: 10 Inner: 5
UPC: 8-02090-17316-5

17317 MM - FOAM TRAY

Master: 10 Inner: 5
UPC: 8-02090-17317-2



7 pc Ratcheting Combination Wrench Sets

- SAE sizes include: 5/16, 3/8, 7/16, 1/2, 9/16, 5/8, & 11/16
- Metric sizes include: 8, 10, 12, 13, 14, 15, 17
- 72 fine-tooth ratchet design for fast performance
- Less than 5 degree sweep for use in tight spots
- Reusable storage rack

17356 SAE - HANG TAB

Master: 18 Inner: 6
UPC: 8-02090-17356-1

17357 MM - HANG TAB

Master: 18 Inner: 6
UPC: 8-02090-17357-8



5 pc Recessed Combination Wrench Sets

- Carbon Steel Construction
- Handy storage holder
- SAE wrench sizes include: 3/8", 7/16", 1/2", 9/16", 5/8"
- Metric wrench sizes include: 10, 12, 13, 14, & 15mm

17382 SAE - CARDED

Master: 48 Inner: 6
UPC: 8-02090-17382-0

17383 Metric - CARDED

Master: 48 Inner: 6
UPC: 8-02090-17383-7



8 pc Triple Square L-Shaped Wrench Set

- Size includes: M3, M4, M5, M6, M8, M9, M10, M12
- Labeled sizes holder for added convenience

12733 SAE - CARDED

Master: 36 Inner: 6
UPC: 8-02090-12733-5



10 pc 5-Lobe Tamper Resistant Wrench Set

- Size includes: IPR9, IPR10, IPR15, IPR20, IPR25, IPR27, IPR30, IPR40, IPR45, & IPR50
- Labeled sizes holder for added convenience

12734 Metric - CARDED

Master: 36 Inner: 6
UPC: 8-02090-12734-2



8 pc T-handle Hex Key Sets

- Detent ball securely holds fastener in place
- SAE sizes include: 1/8, 9/64, 5/32, 3/16, 7/32, 1/4, 5/16, 3/8"
- Metric sizes Includes: 3, 4, 5, 5.5, 6, 7, 8 & 10mm

12748 SAE - BOXED

Master: 12 Inner: 6 UPC: 8-02090-12748-9

12749 Metric - BOXED

Master: 12 Inner: 6 UPC: 8-02090-12749-6



NEW PRODUCTS

Turbo Swivel Hex Key Sets

- SAE sizes include: 3/16, 7/32, 1/4, 5/16 and 3/8" sizes
- Metric sizes include: 3, 4, 5, 6, 8, 10mm
- Star sizes include: T25, T27, T30, T40, T45, & T50
- Double-jointed design allows access to confined areas
- Free-spinning sleeve for quick removal of fasteners
- Durable heat-treated CRV Steel - Storage pouch included

12753 5 pc SAE - POUCH

Master: 24 Inner: 6 UPC: 8-02090-12753-3

12754 6 pc Metric - POUCH

Master: 24 Inner: 6 UPC: 8-02090-12754-0

12755 6 pc Star - POUCH

Master: 24 Inner: 6 UPC: 8-02090-12755-7



13 pc Tamper Resistant Hex Bit Socket Sets

- S2 alloy steel bits for strength and durability - For use with pin type tamper resistant hex fasteners
- 1/4" and 3/8" drive bit holders - Handy magnetic holder sticks to most metal surfaces
- SAE sizes include: 1/16, 3/32, 1/8, 9/64, 5/32, 3/16, 7/32, 1/4, 5/16, 3/8 and 7/16"
- Metric sizes include: 1.5mm, 2, 2.5, 3, 4, 5, 5.5, 6, 7, 8 and 10mm
- Star sizes include: TP8, 10, 15, 20, 25, 27, 30, 40, 45, 50 and TP55

16135 13 pc SAE Set - CARDED

Master: 48 Inner: 6 UPC: 8-02090-16135-3

16136 13 pc Metric Set - CARDED

Master: 48 Inner: 6 UPC: 8-02090-16136-0

16137 13 pc Star Set - CARDED

Master: 48 Inner: 6 UPC: 8-02090-16137-7



9 pc XZN Triple Square Socket Set

- S2 alloy steel bits for strength and durability
- Reusable rail for added convenience
- Sizes include:
1/4" Dr: M4 & M5, 3/8" Dr: M6, M8, & M10, 1/2" Dr: M12, M14, M16, & M18

16144 - CARDED

Master: 24 Inner: 6
UPC: 8-02090-16144-5



11 pc Tamper Resistant 5-Lobe Bit Socket Set

- S2 alloy steel bits for strength and durability - Reusable rail for added convenience
- Sizes include:
3/8" Dr: IPR10, IPR15, IPR20, IPR25, IPR27, & IPR30
1/2" Dr: IPR40, IPR45, IPR47, IPR50, IPR5

16145 - CARDED

Master: 24 Inner: 6
UPC: 8-02090-16145-2



13 pc Tamper Resistant Hex Bit Socket Sets with Rails

- S2 alloy steel bits for strength and durability
- Reusable rail for added convenience
- SAE sizes include: 1/4" Dr: 5/64, 3/32, 7/64, 1/8, 9/64, & 5/32"
3/8" Dr: 3/16, 7/32, 1/4, 5/16, & 3/8", 1/2" Dr: 7/16 & 1/2"
- Metric sizes include: 1/4" Dr: 2, 2.5, 3, 4, 5, 5.5mm, 3/8" Dr: 6-10mm,
1/2" Dr: 11&12mm

16146 SAE - CARDED

Master: 24 Inner: 6 UPC: 8-02090-16146-9

16147 Metric - CARDED

Master: 24 Inner: 6 UPC: 8-02090-16147-6

12 pc Ribe Bit Socket Set

- S2 alloy steel bits for strength and durability
- Reusable rail for added convenience
- Sizes include: 1/4" Dr: M4 & M5, 3/8" Dr: M6 - M10, 1/2" Dr: M11 - M16

16149 - CARDED

Master: 24 Inner: 6
UPC: 8-02090-16149-0



NEW PRODUCTS

TITAN

12 pc Tamper-Resistant Star Bit Socket Set

- S2 alloy steel bits for strength and durability
- Reusable rail for added convenience
- Sizes include: 1/4" Dr: T10, T15, T20, T25, T27, & T30, 3/8" Dr: T40, T45, T47, T50, & T55, 1/2" Dr: T60

16152 - CARDED

Master: 24 Inner: 6
UPC: 8-02090-16152-0



Large Hex Bit Socket Sets

- Reusable rail for added convenience
- S2 alloy steel bits for strength & durability
- SAE sizes include: 1/2" Dr: 9/16, 5/8, 11/16, 3/4, 13/16, & 7/8"
- Metric sizes include: 1/2" Dr: 13, 14, 15, 17, 19, 21 & 22mm
- SAE & Metric sizes include: 1/2" Dr: SAE: 9/16, 5/8, 11/16, & 3/4" 1/2" Dr: MM: 14, 15, 17, & 19mm

16156 6 pc SAE - CARDED

Master: 12 Inner: 4 UPC: 8-02090-16156-8

16157 7 pc Metric - CARDED

Master: 12 Inner: 1 UPC: 8-02090-16157-5

16158 8pc SAE/Metric - CARDED

Master: 12 Inner: 4 UPC: 8-02090-16158-2



13 pc Bit Socket Sets

- S2 alloy steel bits for strength and durability - Reusable rail for added convenience
- Star sizes include: 1/4" Dr: T10, T15, T20, T25, T27, & T30 3/8" Dr: T40, T45, T47, T50, & T55, 1/2" Dr: T60 & T70
- SAE sizes include: 1/4" Dr: 5/64, 3/32, 7/64, 1/8, 9/64, & 5/32" 3/8" Dr: 3/16, 7/32, 1/4, 5/16, & 3/8", 1/2" Dr: 7/16 & 1/2"
- Metric sizes include: 1/4" Dr: 2, 2.5, 3, 4, 5, & 5.5mm, 3/8" Dr: 6-10mm, 1/2" Dr: 11 & 12mm

16153 Star - CARDED

Master: 24 Inner: 6 UPC: 8-02090-16153-7

16154 SAE Hex - CARDED

Master: 24 Inner: 6 UPC: 8-02090-16154-4

16155 Metric Hex - CARDED

Master: 24 Inner: 6 UPC: 8-02090-16155-1



13 pc External Star Socket Set

- CRV Construction
- Sizes includes: 1/4" DR: E-4, E-5, E-6, E-7, E-8 3/8" DR: E-10, E-12, E-14, E-16, 1/2" DR: E-18, E-20, E-22, E24

16159 - CARDED

Master: 24 Inner: 6
UPC: 8-02090-16159-9



9 pc 3/8" Dr. Stubby XZN Triple Square Impact Bits

- Sizes include: 1/4" DR: M4, M5, M6, M8, 3/8" DR: M10, & M12 1/2" Dr: MT14, MT16, MT18 Tamper
- Includes rail storage rack
- Impact Grade

16138 - CARDED

Master: 24 Inner: 6
UPC: 8-02090-16138-4



9 pc Hex MM Stubby Impact Bit Socket Set

- Impact Grade
- Sizes include: 1/4" Dr: 6, 7, 8, & 10mm, 3/8" Dr: 12, 14, 17, 18, & 19mm
- Includes rail storage rack

16141 - CARDED

Master: 24 Inner: 6
UPC: 8-02090-16141-4

16140 - CARDED

Master: 24 Inner: 6
UPC: 8-02090-16140-7



NEW PRODUCTS

10 pc Stubby Star Bit Socket Sets

16142 - CARDED

Master: 24 Inner: 6
UPC: 8-02090-16143-8



16143 TR - CARDED

Master: 24 Inner: 6
UPC: 8-02090-16143-8



1/2" Dr. Lug Nut Socket

- Non-marring core and sleeve protects from scratches and abrasion
- Attractive color-coded, anodized finishes for easy identification

21091 17mm - HANG TAB

Master: 48 Inner: 12 UPC: 8-02090-21091-4

21092 19mm - HANG TAB

Master: 48 Inner: 12 UPC: 8-02090-21092-1

21093 21mm - HANG TAB

Master: 48 Inner: 12 UPC: 8-02090-21093-8

21094 22mm - HANG TAB

Master: 48 Inner: 12 UPC: 8-02090-21094-5



T-Handle Wrenches

- Free spinning allows for constant pressure while turning tool
- Faster than ordinary speed wrenches
- Finish jobs in a fractions of the time

12740 1/4" Dr. - POLYBAG

Master: 12 Inner: 6 UPC: 8-02090-12740-3

12742 3/8" Dr. - POLYBAG

Master: 12 Inner: 6 UPC: 8-02090-12742-7

12744 1/2" Dr. - POLYBAG

Master: 12 Inner: 6 UPC: 8-02090-12744-1

12746 4 pc Set, 1/4, 3/8, & 1/2" Wrenches & 1/4" Dr. Bit Driver - FOAM TRAY

Master: 5 Inner: 1 UPC: 8-02090-12746-5

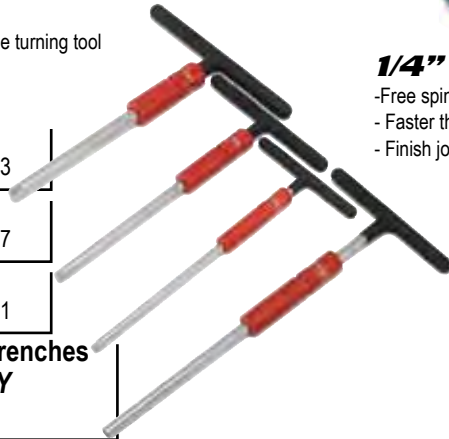

1/4" T-Handle Bit Driver

- Free spinning allows for constant pressure while turning tool
- Faster than ordinary speed wrenches
- Finish jobs in a fractions of the time

12751 - POLYBAG

Master: 12 Inner: 6
UPC: 8-02090-12751-9

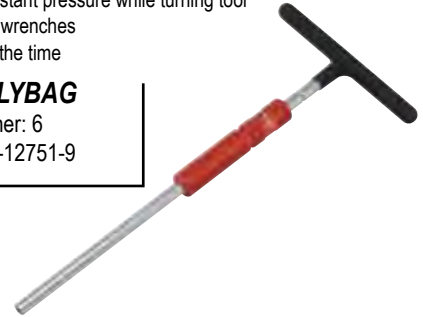

5 pc Wobble Adapter Set

- Sizes include: 1/4"-3/8", 3/8"-1/4", 3/8"-1/2", 1/2" - 3/8", 1/2" to 3/4"
- Impact Grade
- Handy tray for storage

16150 - TRAY

Master: 24 Inner: 6
UPC: 8-02090-16150-6



5 pc 1/2" Dr. 12 pt Axle Nut Socket Set

- Includes: 30, 32, 34, 36 and 39mm
- Convenient blow mold case

15345 - BOXED

Master: 5 Inner: 1
UPC: 8-02090-15345-7



NEW PRODUCTS

3" Impact Locking Socket Adapters

- 3" impact grade socket adapter
- 1/4" hex shank fits any standard drill chuck
- Quick-release locking mechanism prevents sockets from coming off unexpectedly

15211 1/4" Dr. - CARDED

Master: 144 Inner: 12 UPC: 8-02090-15211-5

15212 3/8" Dr. - CARDED

Master: 144 Inner: 12 UPC: 8-02090-15212-2

15213 1/2" Dr. - CARDED

Master: 144 Inner: 12 UPC: 8-02090-15213-9

15210 3 pc Set, 1/4, 3/8 & 1/2" - CARDED

Master: 72 Inner: 6 UPC: 8-02090-15210-8



6" Impact Locking Socket Adapters

- 6" impact grade socket adapter
- 1/4" hex shank fits any standard drill chuck
- Quick-release locking mechanism prevents sockets from coming off unexpectedly

15215 1/4" Dr. - CARDED

Master: 96 Inner: 12 UPC: 8-02090-15215-3

15216 3/8" Dr. - CARDED

Master: 96 Inner: 12 UPC: 8-02090-15216-0

15217 1/2" Dr. - CARDED

Master: 96 Inner: 12 UPC: 8-02090-15217-7

15214 3 pc Set, 1/4, 3/8 & 1/2" - CARDED

Master: 72 Inner: 6 UPC: 8-02090-15214-6



Brake Fluid Tester

- Quickly determine percentage of moisture in brake fluid
- Auto power off after 12 seconds of inactivity
- Indicator Lights
- Battery (included): (1) 1.5V, type AAA

51400 - CARDED

Master: 100 Inner: 10
UPC: 8-02090-51400-5

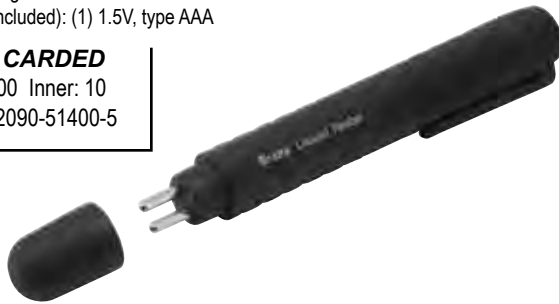

AC Fin Comb

- Cleans and straightens condenser and evaporator fins
- 6-sided head for 8, 9, 10, 12, 14 and 15 fins-per-inch applications

51500 - CARDED

Master: 48 Inner: 6
UPC: 8-02090-51500-2



5 pc Suspension Separator Kit

- Includes 3 drop forged forks: 11/16, 15/16" & 1-1/8"
- One handle for use with hammer
- One handle designed for use with pneumatic air hammer
- Both handles are interchangeable.
- Chrome vanadium steel construction
- Convenient blow mold case

51800 - BOXED

Master: 10 Inner: 1
UPC: 8-02090-51800-3



Tie Rod Separator

- Chrome vanadium steel construction

51801 - CARDED

Master: 20 Inner: 5
UPC: 8-02090-51801-0



Ball Joint Separator

- Chrome vanadium steel construction

51802 - CARDED

Master: 20 Inner: 5
UPC: 8-02090-51802-7



Adjustable

Torque Screwdrivers

- 3 - 15 in-lbs. - Comfortable TPR Rubber Handle
- Locks in calibrating position for unwanted setting changes
- Torques on both right hand and left hand threads
- Can be re-calibrated - Accuracy: +/- 3% - 90-day Warranty

23156 1/4" Hex Dr. - STORAGE CASE

Master: 54 Inner: 1
UPC: 8-02090-23156-8

23157 1/4" Square Dr. - STORAGE CASE

Master: 54 Inner: 1
UPC: 8-02090-23157-5



20 pc Screwdriver Bit Set

- Size includes:
- Phillips: 0, 1, 2, 2, 3, Slotted: 3, 4, 5, 6, 7,
- Square: 1, 2, 3, Star: T15, T20, T25, T30
- Metric Hex: 4, 5, 6 mm
- Reusable bit holder

16541 - CARDED

Master: 36 Inner: 6
UPC: 8-02090-16541-2



Retractable Mini Razor Scraper

- Text here

12033 - CARDED

Master: 72 Inner: 12
UPC: 8-02090-12033-6

12037 - DISPLAY

Master: 72 Inner: 9
UPC: 8-02090-12037-4



7-in-1 Multi-Function Tool

- Includes:
- (2) Flat Head Screwdriver
- Bottle Opener
- Knife
- Phillips Screwdriver
- Key Chain
- LED light

12134 - CARDED

Master: 48 Inner: 6
UPC: 8-02090-12134-0



Multi Function Tool Keychain

- Includes tack puller, pliers, hammer, small knife, bottle opener, safety lock
- Keychain for portability

12003 - CARDED

Master: 36 Inner: 6
UPC: 8-02090-12003-9



Multi Function Tool

- Head Rotates for acces to tight spaces
- Includes close quarter hammer & ratcheting screwdriver
- Bit storage in handle

32979 - CARDED

Master: 36 Inner: 6
UPC: 8-02090-32979-1



Ratcheting Wire Terminal Crimper

- Ratcheting mechanism design
- Adjustable crimping compression
- Steel jaw
- Color coded wire sizes
 - red 22-18AWG-DIN 0.5-1.0mm
 - blue 16-14AWG-DIN 1.5mm-2.5mm
 - yellow 12-10AWG-DIN 4-6mm; grip

11477 - CARDED

Master: 40 Inner: 10
UPC: 8-02090-11477-9



Pistol Grip Wire Stripper

- For fast, easy and accurate wire stripping
- Adjustable hardened steel blades
- Locking handle
- Includes wire cutter

11479 - CARDED

Master: 60 Inner: 10
UPC: 8-02090-11479-3



Micrometer Torque Wrenches

- Reversible ratchet mechanism for quicker use
- Locking handle prevents unwanted setting changes
- 20 to 200 inch-pound range

23146 1/4" Dr. - CLAMSHELL

Master: 12 Inner: 1 UPC: 8-02090-23146-9

23147 3/8" Dr. - CLAMSHELL

Master: 12 Inner: 1 UPC: 8-02090-23147-6

23148 1/2" Dr. - CLAMSHELL

Master: 12 Inner: 1 UPC: 8-02090-23148-3



PVC Pipe Reamer

- Smooth retracting/locking blade advance
- Convenient blade storage
- Includes 3 extra heavy duty .02" razor blades

15065 - CARDED

Master: 48 Inner: 12
UPC: 8-02090-15065-4

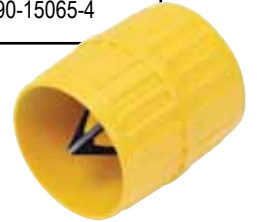

Single Flare Tool

- 45 degree flare and taper
- Die sizes: 3/16, 1/4, 5/16, 3/8, 1/2, & 5/8"
- Works well with soft tubing
- For use with soft brass, copper, and aluminum tubing

15062 - CARDED

Master: 24 Inner: 6
UPC: 8-02090-15062-3



Stepped Faucet Seat Wrench

- Used to remove faucet body valve seat

15060 - CARDED

Master: 60 Inner: 10
UPC: 8-02090-15060-9



Tapered Faucet Seat Wrench

- Used to remove faucet body valve seat

15061 - CARDED

Master: 60 Inner: 10
UPC: 8-02090-15061-6

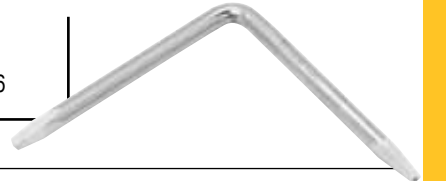

Garbage Disposal Tool

- For freeing jammed shredder plates
- Fits most garbage disposals
- Extended handle for safe use

15066 - CARDED

Master: 48 Inner: 12
UPC: 8-02090-15066-1



Ratcheting PVC Pipe Cutter

- Cuts PVC or rubber pipe up to 1-5/8" (41mm) diameter
- Stainless steel blade
- Flip catch holds handles closed for safety

15063 - CARDED

Master: 36 Inner: 6
UPC: 8-02090-15063-0



NEW PRODUCTS

5 pc Power Nut Driver Sets

- Impact grade
- SAE sizes include: 1/4", 5/16", 3/8", 7/16" and 1/2"
- Metric sizes include: 8, 10, 12, 13 and 14mm
- 1/4" hex shank fits any standard drill chuck
- Includes handy storage rail

15220 SAE - CARDED

Master: 48 Inner: 6
UPC: 8-02090-15220-7

15221 Metric - CARDED

Master: 48 Inner: 6
UPC: 8-02090-15221-4



6 pc Nut Driver Sets

- Impact grade
- Color ring for easy size identification
- 1/4" hex shank fits any standard drill chuck
- Includes handy storage rail
- SAE sizes include: 1/4, 5/16, 3/8, 7/16, 1/2, 9/16"
- Metric sizes include: 8, 10, 12, 13, 14, 15mm

15222 SAE - CARDED

Master: 48 Inner: 6
UPC: 8-02090-15222-1

15223 Metric - CARDED

Master: 48 Inner: 6
UPC: 8-02090-15223-8



2 pc #2 Phillips Power Bit Set

- Impact Grade
- Fits standard 1/4" hex drivers

16213 2 In. - CARDED

Master: 96 Inner: 24
UPC: 8-02090-16213-8

16215 6 In. - CARDED

Master: 96 Inner: 24
UPC: 8-02090-16215-2

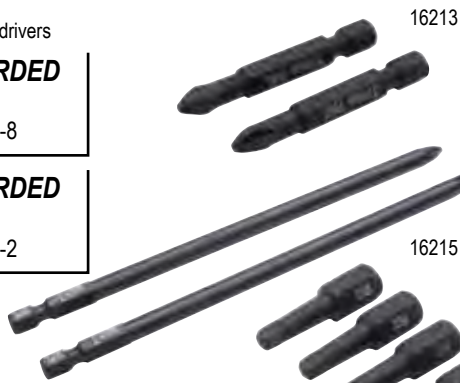

5 pc 1" Impact Grade Phillips Power Bit Set

- Impact Grade
- Fits standard 1/4" hex drivers

16212 - CARDED

Master: 400 Inner: 20
UPC: 8-02090-16212-1



#2 Square Power Bit Sets

- Impact Grade
- Fits standard 1/4" hex drivers

16223 5 pc 1 In. - CARDED

Master: 400 Inner: 40 UPC: 8-02090-16223-7

16224 2 pc 2 In. - CARDED

Master: 400 Inner: 40 UPC: 8-02090-16224-4

16226 2 pc 6 In. - CARDED

Master: 400 Inner: 40 UPC: 8-02090-16226-8

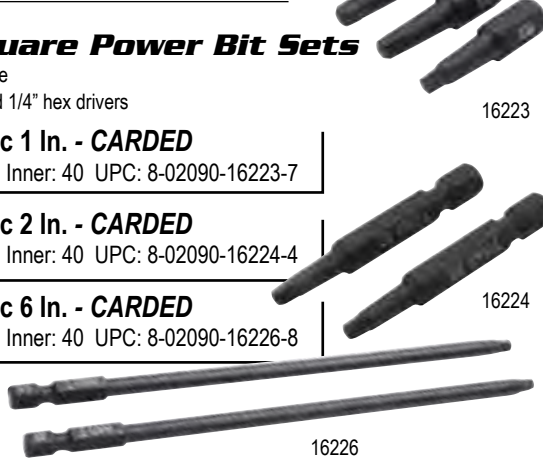

Ball Driver with Bits

- Stainless steel shaft - Magnetic tip
- Knurled for better grip - Convenient storage in handle
- Contents Includes:
Phillips: #1, 2, 3, Square: #1, 2
Slotted: 1/4, 3/16, 1/8"

16062 - CARDED

Master: 36 Inner: 6
UPC: 8-02090-16062-2

16063 - DISPLAY

Master: 12 Inner: 144
UPC: 8-02090-16063-9



8 pc 2-in-1 Countersink Bit Set

- Each bit doubles as a countersink and a Phillips screwdriver bit
- Contains 8 double-ended bits:
2 ea: #1 Phillips, 4 ea: #2 Phillips, 2 ea: #3 Phillips
- Includes handy storage rail

16244 - CARDED

Master: 72 Inner: 6
UPC: 8-02090-16244-2



2 pc Countersink Phillips Bit Sets

- Contains 2 Two-inch dual purpose countersink Phillips bits
- Use one bit to countersink and drive screws
- Fits standard 1/4" hex drivers

16241 #1 - CARDED

Master: 400 Inner: 40 UPC: 8-02090-16241-1

16242 #2 - CARDED

Master: 400 Inner: 40 UPC: 8-02090-16242-8

16243 #3 - CARDED

Master: 400 Inner: 40 UPC: 8-02090-16243-5



NEW PRODUCTS

Plumbers Brush

- For 1/2" & 3/4" tubing I.D. and O.D.
- Make cleaning tubing and fittings prior to soldering easy and effective
- Ensures proper surface penetration and good solder joint

15064 - CARDED

Master: 96 Inner: 12
UPC: 8-02090-15064-7



5 pc Hex Shank Drill Bit Set

- High Speed Steel bits for wood, plastic & metal
- Use with a bit holder or insert directly into a drill
- Sizes include: 1/16", 3/32", 1/8", 5/32", 3/16"
- Convenient storage case

16505 - CARDED

Master: 24 Inner: 6
UPC: 8-02090-16505-4



Magnifying Glass with LED Light

- Bright LED light illuminates subject
- 2.2x Non-distorting optical grade glass lens
- Comfortable TPR rubber grip handle
- TPR rubber framing for extra protection
- Uses 3 LR-44 batteries (included)
- Ships in 9-pack counter display

15029 - DISPLAY

Master: 72 Inner: 9
UPC: 8-02090-15029-6



13 pc Mini File Set

- 12 high strength carbon steel files
- Ergonomic interchangeable handle with quick release
- Durable nylon pouch
- Includes Flat, Triangle, Flat-Point, Knife-Type, Square, Barette

17067 - BOX

Master: 24 Inner: 6
UPC: 8-02090-17067-6

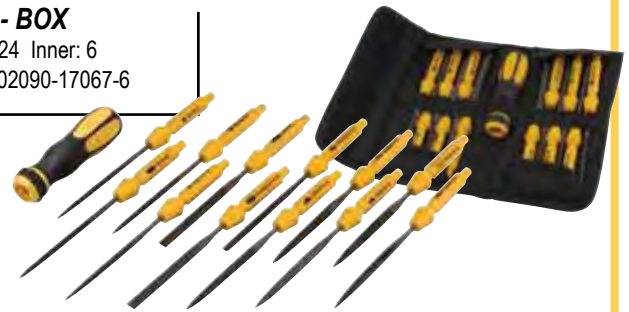

38 pc Bore Brush Set

- 12 Stainless steel brushes - 8mm thru 19mm
- 12 Brass brushes - 8mm thru 19mm
- 12 Nylon brushes - 8mm thru 19mm
- Quick release driver
- 6" quick release extension
- Blow molded storage case

51501 - COLOR SLEEVE

Master: 12 Inner: 6
UPC: 8-02090-51501-9



Collapsible Rubber Magnetic Parts Tray

- Size: 2 to 5 inches
- Sticks to any ferrous metal surface
- Rubber covered prevents scratching

21266 - DISPLAY

Master: 36 Inner: 6
UPC: 8-02090-21266-6



Inspection Mirror

- Clear glass reflection
- All angle ball joint
- Telescopes up to 35 inches
- Cushion grip handle
- CR2032 Batteries included
- LED light

32959 - DISPLAY

Master: 36 Inner: 6
UPC: 8-02090-32959-3



Self Adjusting Wire Stripper

- Cuts and strip solid or stranded 12-22 gauge wire
- Automatically adjusts to wire size - Handles single or multiple conductor wire
- Easy to use - yields clean, nick-free results every time
- Not designed to strip thread seal tape or similar insulations

11469 - CARDED

Master: 48 Inner: 12
UPC: 8-02090-11469-4



Service Cart

- WITH LOCKING WHEELS
- 3 Trays service tool cart
- 4" x 1" castors
- Powder coating finished
- Product size: 28.5" x 15" x 30.5"
- N.W: 29.7lbs

21002 - BOXED

Master: 1 Inner: 1
UPC: 8-02090-21002-0



Service Tool Cart with Drawers

- DUAL LOCKING DRAWERS AND SLIDING TOP
- Ball bearing slides for the drawers
- 4" x 1" wheels: 2 fixed, 2 swivel
- Powder coating finished
- Product size: 27-3/4 x 14-9/16 x 28"
- N.W: 59.5lbs

21003 - BOXED

Master: 1 Inner: 1
UPC: 8-02090-21003-7



Professional Work Bench

- Durable Powder Coated Finish - Full bottom shelf
- Weight capacity: 1,200 lbs
- Top panel: 13 gauge steel - Bottom shelf: 13 gauge steel
- Steel support: 12 gauge steel
- Overall Dimensions: 60" W x 31" D x 34" H

21006 - BOXED

Master: 1 Inner: 1
UPC: 8-02090-21006-8



Replacement Hardware Kit for 21006

21006-01 - BOXED

Master: 1 Inner: 1
UPC: 8-02090-00033-1

Professional Work Bench with Drawers

- Durable Powder Coated Finish - Full bottom shelf - Weight capacity: 1,200 lbs
- Top panel: 13 gauge steel - Bottom shelf: 13 gauge steel
- Steel support: 12 gauge steel - Includes two locking drawers
- Overall Dimensions: 59" W x 25" D x 34" H

21007 - BOXED

Master: 1 Inner: 1
UPC: 8-02090-21007-5



Replacement Hardware Kit for 21007

21007-01 - BOXED

Master: 1 Inner: 1
UPC: 8-02090-00034-8

Professional Folding Work Bench

- Table folds with ease for convenient storage
- Peg Holes for Hanging Tools
- Gas Struts for easy folding - Heavy duty
- 500lbs Capacity - Size: 47 x 25 x 54"
- Thickness: .07" - N.W.: 99lbs

21004 - BOXED

Master: 1 Inner: 1
UPC: 8-02090-21004-4





This Section Includes:

PAINT, BODY AND EQUIPMENT

AIR TOOLS / AIR TOOL ACCESSORIES

WELDING

POWER TOOLS / POWER TOOL ACCESSORIES

NEW VAPER PRODUCTS

Gravity Feed HVLP Spray Guns

- Brass Fluid & Air Nozzle - 600cc Plastic Paint Cup
- Includes locking air regulator with gauge
- Air Consumption: 7.0 - 9.0 CFM
- Air Inlet: 1/4"

1.4mm BLUE BODY

19000 - DISPLAY BOX

Master: 10 Inner: 1
UPC: 8-02090-19000-1

1.8mm RED BODY

19018 - DISPLAY BOX

Master: 10 Inner: 1
UPC: 8-02090-19018-6

2.3mm RED BODY

19023 - DISPLAY BOX

Master: 10 Inner: 1
UPC: 8-02090-19023-0



3 pc Dual Set-Up HVLP Spray Gun Set

Set includes:

- One spray gun with a 1.4mm needle and nozzle set for lighter materials
- A second spray gun with a 1.7mm needle and nozzle set for heavier materials
- Locking Pressure regulator with gauge

Features and specs:

- 1000 ml aluminum paint cups
- Spray pattern control knob
- Air Inlet: 1/4"
- Operating pressure: 15 - 45 P.S.I.
- Avg. Air consumption: 7.0 - 9.0 C.F.M.

19100 - DISPLAY BOX

Master: 5 Inner: 1
UPC: 8-02090-19100-8



3 pc HVLP Dual Set-Up Spray Gun Kit

- Set includes:

- 1.4mm needle / nozzle set for lighter materials
- 1.7mm needle / nozzle set for heavier materials
- Locking Pressure regulator with gauge
- 1000 ml aluminum paint cups
- Spray pattern control knob on side
- Air Inlet: 1/4"
- Operating pressure: 15-45 PSI
- Avg. Air consumption: 7.0-9.0 CFM

19800 - DISPLAY BOX

Master: 5 Inner: 1
UPC: 8-02090-19800-7



3 pc HVLP Dual Set-Up Spray Gun Kit

- Gun A - 1.0 mm for touch up work
- Gun B - 1.4 mm for bases and clear coats
- Locking pressure regulator with gauge

All Guns:

- Aluminum paint cups
- Die cast aluminum body with chrome plated finish
- 2-Step trigger control - Stainless steel nozzles
- Non-bleeder type, gravity feed external mix
- Adjustable spray width, air inlet and fluid outlet

19219 - DISPLAY BOX

Master: 5 Inner: 1
UPC: 8-02090-19219-7



HVLP Touch-Up Spray Gun

- 1.0 mm touch up gun - 100 cc Aluminum paint cup
- Ships in reusable storage tray
- Includes cleaning kit with maintenance tools

19110 - CARDED

Master: 5 Inner: 1
UPC: 8-02090-19110-7

REPLACEMENT NEEDLES

19110-01

Master: 1 Inner: 1

METAL TRIGGER

19110-07

Master: 1 Inner: 1



Gravity Feed HVLP Spray Gun

- Includes locking pressure regulator with gauge
- 1000 ml aluminum paint cup
- Spray pattern control knob on side of guns
- Air Inlet: 1/4"
- Operating pressure: 15 - 45 P.S.I.
- Avg. Air consumption: 7.0 - 9.0 C.F.M.

1.3mm NEEDLE & NOZZLE

19113 - DISPLAY BOX

Master: 5 Inner: 1
UPC: 8-02090-19113-8

1.5mm NEEDLE & NOZZLE

19115 - DISPLAY BOX

Master: 5 Inner: 1
UPC: 8-02090-19115-2

2.0mm NEEDLE & NOZZLE

19120 - DISPLAY BOX

Master: 5 Inner: 1
UPC: 8-02090-19120-6

1.4mm NEEDLE & NOZZLE

19114 - DISPLAY BOX

Master: 5 Inner: 1
UPC: 8-02090-19114-5

1.7mm NEEDLE & NOZZLE

19117 - DISPLAY BOX

Master: 5 Inner: 1
UPC: 8-02090-19117-6

2.3mm NEEDLE & NOZZLE

19123 - DISPLAY BOX

Master: 5 Inner: 1
UPC: 8-02090-19123-7



4 pc HVLP Triple Set-Up Spray Gun Kit

- Gun A - 1.0 mm nozzle set for touch up work
- Gun B - 1.4mm nozzle set for lighter materials
- Gun C - 1.7mm nozzle set for heavier materials
- Locking pressure regulator with gauge

All Guns:

- Aluminum paint cups
- Die cast aluminum body with chrome plated finish
- 2-Step trigger control
- Non-bleeder type, gravity feed external mix
- Stainless steel nozzles
- Adjustable spray width, air inlet and fluid outlet

19220 - DISPLAY BOX

Master: 5 Inner: 1
UPC: 8-02090-19220-3



4 pc HVLP Triple Set-Up Spray Gun Kit

in Aluminum Case

- Gun A - 1.0 mm nozzle set for touch up work
- Gun B - 1.4mm nozzle set for lighter materials
- Gun C - 1.7mm nozzle set for heavier materials
- Locking pressure regulator with gauge

All Guns:

- Aluminum paint cups
- Die cast aluminum body with chrome plated finish
- 2-Step trigger control
- Non-bleeder type, gravity feed external mix
- Stainless steel nozzles
- Adjustable spray width, air inlet and fluid outlet

19221 - DISPLAY BOX

Master: 3 Inner: 1
UPC: 8-02090-19221-0



4 pc HVLP Limited Edition Triple Set-Up Spray Gun Kit with Case

Blue Gun - 1.0 mm nozzle set for lighter materials and touch up work

Red Gun - 1.4mm nozzle set for lighter materials

Green Gun - 1.7mm nozzle set for heavier materials

Locking pressure regulator with gauge

Bonus storage/carry case

All Guns:

- Spun aluminum paint cups - Die cast aluminum body

- 2-Step trigger control - Stainless steel nozzles

- Non-bleeder type, gravity feed external mix

- Adjustable spray width, air inlet and fluid outlet

19229 - DISPLAY BOX

Master: 3 Inner: 1

UPC: 8-02090-19229-6



4 pc HVLP Dual Set-Up Spray Gun Kit

Versatile spray gun kit includes:

Gun A - 1.4 mm production gun

Gun B - 1.7mm production gun

- Locking pressure regulator with gauge

- 6" Random orbital sander for paint prep and finishing applications

- Mesh filters for gravity feed paint cups

- 2 spray gun wrenches - Cleaning brush

19223 - DISPLAY BOX

Master: 3 Inner: 1

UPC: 8-02090-19223-4



Waterborne Ready HVLP Production Spray Gun

- 1.4 mm needle and nozzle for high quality

bases and clear coats

- Fast working speed and wide pattern

- Stainless steel needle and fluid tip

- 600ml plastic paint cup

- Cleaning kit included

19614 - DISPLAY BOX

Master: 10 Inner: 1

UPC: 8-02090-19614-0

19614-14 - BOXED

Master: 1 Inner: 1



Siphon Feed Production Spray Gun

- Fully adjustable spray pattern

- 1.8 mm needle and nozzle set for heavier materials

- Non bleeder type, siphon feed

- External mix for fine atomization

- Spun aluminum 1 liter cannister

19418 - DISPLAY BOX

Master: 10 Inner: 1

UPC: 8-02090-19418-4



Needles and Nozzles

- For use with 19100 and 19200 series spray guns

1.4mm Needle & Nozzle

19100-14 - BOXED

Master: 1 Inner: 1

2.0mm Needle

19100-20 - BOXED

Master: 1 Inner: 1

1.7mm Needle

19100-17 - BOXED

Master: 1 Inner: 1

2.3mm Needle & Nozzle

19100-23 - BOXED

Master: 1 Inner: 1

Spray Gun Needles & Nozzle Sets

- For use with 19000 series spray guns

1.4mm Needle & Nozzle

19000-14 - BOXED

Master: 1 Inner: 1

2.0mm Needle

19000-20 - BOXED

Master: 1 Inner: 1

1.7mm Needle

19000-17 - BOXED

Master: 1 Inner: 1

2.3mm Needle & Nozzle

19000-23 - BOXED

Master: 1 Inner: 1

1000ml Paint Cup Replacement Lid

- Genuine VAPER® Replacement Part
- Fits VAPER 19100 & 19200 Series gravity feed production spray guns
- Snug fitting press fit
- For 1000ml capacity aluminum paint cups

19907 - CARDED

Master: 24 Inner: 6
UPC: 8-02090-19907-3



5 pc In-line Filter Screens

- Genuine VAPER® Replacement Part
- Fits all VAPER® Gravity feed spray guns
- In-line mesh filter removes dirt particles from paint to protect against defects
- Insert into gravity feed spray gun fluid inlet prior to cup installation

19911 - CARDED

Master: 144 Inner: 12
UPC: 8-02090-19911-0



Air Spray Gun Holder

- Heavy duty steel construction
- Funnel holder over paint cup for easy filling

19990 - DISPLAY BOX

Master: 10 Inner: 5
UPC: 8-02090-19990-5



Magnetic Spray Gun Holder

- Provides convenient storage of gravity feed spray guns when not in use
- Attaches to spray booth walls, work stations, tool boxes or any metal surface
- Vinyl coated hooks protect spray gun finish from scratches
- Spray gun not included

19991 - CARDED

Master: 24 Inner: 6
UPC: 8-02090-19991-2



Dual Action Gravity Feed Airbrush

- Balanced, lightweight design with chrome plated finish
- Dual action trigger for greater control - press down for air; pull back for paint
- For use with automotive or water based paints

19551 - DISPLAY BOX

Master: 20 Inner: 1
UPC: 8-02090-19551-8



1.5mm Air Brush Hose

19552 - BOXED

Master: 1 Inner: 1

Spray Gun Rebuild Kit - 19000 Series Production Guns

- Genuine VAPER® Replacement Part
- Fits VAPER 19000 Series gravity feed production spray guns
- Extend the life of your spray gun
- Includes all parts needed for a rebuild

19908 - CARDED

Master: 144 Inner: 12
UPC: 8-02090-19908-0



Spray Gun Rebuild Kit - 19100 & 19200 Series Production Guns

- Genuine VAPER® Replacement Part
- Fits VAPER 19100 & 19200 Series gravity feed production spray guns
- Extend the life of your spray gun
- Includes all parts needed for a rebuild

19909 - CARDED

Master: 144 Inner: 12
UPC: 8-02090-19909-7



Spray Gun Rebuild Kit - 19100 & 19200 Series Touch-up Guns

- Genuine VAPER® Replacement Part
- Fits VAPER 19100 & 19200 Series gravity feed touch-up spray guns
- Extend the life of your spray gun
- Includes all parts needed for a rebuild

19910 - CARDED

Master: 144 Inner: 12
UPC: 8-02090-19910-3



Spray Gun Cleaning Kit

- Ideal for cleaning all types of paint spray guns
- Maintain your spray guns and keep them lasting longer
- Brushes can be used with all types of paint thinners and spray gun cleaning solvents
- Designed to clean gun and all fluid and air passages without damage

19112 - CARDED

Master: 48 Inner: 6
UPC: 8-02090-19112-1



2 pc Disposable Air Line Filters

- Helps reduce painting defects
- Removes moisture, oil vapor and rust particles that pass through conventional filters
- Mounts at spray gun for best protection
- High flow design minimizes pressure drop to spray gun

19302 - CARDED

Master: 48 Inner: 6
UPC: 8-02090-19302-6



600ml Plastic Gravity Feed Paint Cup

- Genuine VAPER® Replacement Part
- Fits VAPER 19000 Series gravity feed spray guns
- 600ml Capacity
- Includes vented screw-on lid

19900 - DISPLAY BOX

Master: 24 Inner: 6
UPC: 8-02090-19900-4



150ml Paint Cup Replacement Lid

- Genuine VAPER® Replacement Part
- Fits VAPER 19100 & 19200 Series Gravity feed touch-up spray guns
- Snug fitting press fit
- For 150ml capacity stainless steel paint cups

19902 - CARDED

Master: 48 Inner: 6
UPC: 8-02090-19902-8



150ml Stainless Steel Gravity Feed Paint Cup

- Genuine VAPER® Replacement Part
- Fits VAPER 19100 & 19200 Series gravity feed touch-up spray guns
- 150ml Capacity
- Includes snug fitting press fit lid

19903 - DISPLAY BOX

Master: 24 Inner: 6
UPC: 8-02090-19903-5



600ml Paint Mixing Cup

- Works with Vaper gravity feed paint guns
- Translucent design with measurement scale for accurate mixing
- Durable polyethylene plastic for long life
- Includes cup, base stand, caps and coupler
- Cup capacity: 600ml

19905 - DISPLAY BOX

Master: 10 Inner: 1
UPC: 8-02090-19905-9



1000ml Aluminum Gravity Feed Paint Cup

- Genuine VAPER® Replacement Part
- Fits VAPER 19100 & 19200 Series gravity feed production spray guns
- 1000ml Capacity
- Includes snug fitting press fit lid

19906 - DISPLAY BOX

Master: 24 Inner: 6
UPC: 8-02090-19906-6



Adhesive Back Wet/Dry Sandpaper

- 17-3/8" x 2-3/4" (440 x 70mm)
- For metal, plastic and fiberglass surfaces
- Adhesive backing for quick and easy paper changes
- Works with Vaper® Hand Sanding Block #19951 or similar models

80 GRIT

51080 - CARDED

Master: 200 Inner: 25
UPC: 8-02090-51080-9

150 GRIT

51150 - CARDED

Master: 200 Inner: 25
UPC: 8-02090-51150-9

240 GRIT

51240 - CARDED

Master: 200 Inner: 25
UPC: 8-02090-51240-7

320 GRIT

51320 - CARDED

Master: 200 Inner: 25
UPC: 8-02090-51320-6



Adhesive Back Wet/Dry Sandpaper

- 5" x 2-3/4" (135 x 70mm)
- For metal, plastic and fiberglass surfaces
- Adhesive backing for quick and easy paper changes
- Works with Vaper® Hand Sanding Block #19952 or similar models

80 GRIT

52080 - CARDED

Master: 200 Inner: 25
UPC: 8-02090-52080-8

150 GRIT

52150 - CARDED

Master: 200 Inner: 25
UPC: 8-02090-52150-8

240 GRIT

52240 - CARDED

Master: 200 Inner: 25
UPC: 8-02090-52240-6

320 GRIT

52320 - CARDED

Master: 200 Inner: 25
UPC: 8-02090-52320-5



Adhesive Back Wet/Dry Sandpaper

- 7" x 4" (180 x 100mm)
- For metal, plastic and fiberglass surfaces
- Adhesive backing for quick and easy paper changes
- Works with Vaper® Hand Sanding Block #19959 or similar models

80 GRIT

59080 - CARDED

Master: 200 Inner: 25
UPC: 8-02090-59080-1

150 GRIT

59150 - CARDED

Master: 200 Inner: 25
UPC: 8-02090-59150-1

240 GRIT

59240 - CARDED

Master: 200 Inner: 25
UPC: 8-02090-59240-9

320 GRIT

59320 - CARDED

Master: 200 Inner: 25
UPC: 8-02090-59320-8



Flexible Foam Sanding Block

- 17-3/8" x 2-3/4" (440 x 70mm) sanding surface
- Soft molded foam block for maximum comfort and grip
- Made of tough, durable polyurethane
- For use on flat or contoured surfaces

19951 - CARDED

Master: 24 Inner: 4
UPC: 8-02090-19951-6

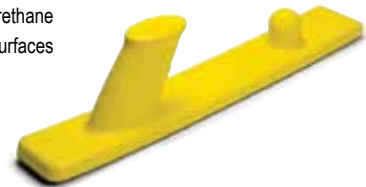

Flexible Foam Sanding Block

- 7" x 4" (180 x 100mm) sanding surface
- Soft molded foam block for maximum comfort and grip
- Made of tough, durable polyurethane
- For use on flat or contoured surfaces

19959 - CARDED

Master: 24 Inner: 6
UPC: 8-02090-19959-2

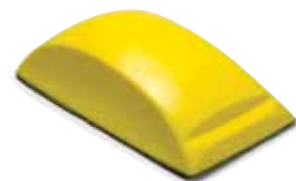

Flexible Foam Sanding Block

- 5" x 2-3/4" (135 x 70mm) sanding surface
- Soft molded foam block for maximum comfort and grip
- Made of tough, durable polyurethane
- For use on flat or contoured surfaces

19952 - CARDED

Master: 36 Inner: 6
UPC: 8-02090-19952-3

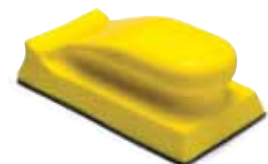

Air Dryer Gun

- Speeds drying time of waterborne industrial coatings
- Variable air flow provides drying flexibility
- Includes intake filter to stop flying debris
- Working air pressure: 2-4 bar
- Max air pressure: 12 bar
- Air consumption at 4 bar: 350 L/min
- Weight: 460g
- Sound pressure at 4 bar: 72dB

19390 - BOXED

Master: 20 Inner: 1
UPC: 8-02090-19390-3

SCREEN

19390-01

Master: 1 Inner: 1

DIRECTIONAL CONE

19390-02

Master: 1 Inner: 1

VALVE ASSEMBLY

19390-03

Master: 1 Inner: 1

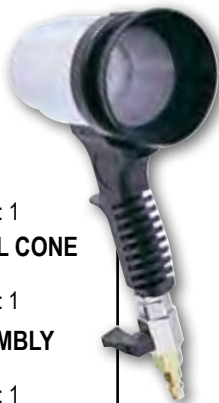

Air Dryer Gun Stand

- Securely holds 2 air dryer guns (not included)
- Air dryer gun rotates 360° and locks in any position
- Includes 2 90 PSI air hoses - Adjustable height up to 82" and width up to 34"
- Steel construction with brass air couplers

19395 - BOXED

Master: 4 Inner: 1
UPC: 8-02090-19395-8



6" Random Orbital Sander

- Low profile design with ergonomic grip
- Random orbital action assures a swirl-free finish
- Variable air speed control - 5mm orbit for rapid material removal
- 6" diameter premium urethane vinyl face pad
- For pre-paint preparation, sanding, feather edging, and touch-up work

19225 - DISPLAY BOX

Master: 10 Inner: 1
UPC: 8-02090-19225-8



6" Sanding Pad

- Standard replacement pad for Vaper item 19225 and other dual action sanders
- For self-adhesive abrasives
- Max operating speed: 10,000 RPM

19226 - CARDED

Master: 10 Inner: 1
UPC: 8-02090-19226-5



19 pc Air Tool Kit

Includes:

- 3/8" Ratchet
- 1/2" Impact Wrench and 1/2" Impact Sockets
SAE sizes: 1/2", 9/16", 5/8", 11/16"
- Metric sizes: 10mm, 12mm, 15mm, 17mm, 19mm
- 3/8" F to 1/2" M Impact Socket Adapter
- 3" 3/8" Impact Extension
- 1/4" NPT Male Industrial Plugs (2)
- Air Tool Oil
- Carry Case

19699 - DISPLAY BOX

Master: 5 Inner: 1
UPC: 8-02090-19699-7



1/4" Swivel Connector

- Convenient for all air tools
- Increases hose life by preventing twists and kinks
- Air flow control knob
- Working pressure: 90 PSI (6Kg/cm2)

19369 - CARDED
 Master: 144 Inner: 12
 UPC: 8-02090-19369-9



1/4" Locking Pressure Regulator with Gauge

- Small & lightweight
- Attaches to all conventional and HVLP spray guns

19303 - CARDED
 Master: 48 Inner: 6
 UPC: 8-02090-19303-3



AMT 3-Way Composite Coupler - 1/4" Female

- Accepts the 3 most popular 1/4" nipple styles:
- A Style: ARO 210 style
- M Style: Milton or industrial style
- T Style: Tru-Flate/Parker Automotive style
- Light and durable nylon construction
- Maximum working pressure: 210 PSI

19304 - CARDED
 Master: 200 Inner: 10
 UPC: 8-02090-19304-3



Fits A, M and T style fittings

AMT 3-Way Composite Coupler - 1/4" Male

- Accepts the 3 most popular 1/4" nipple styles:
- A Style: ARO 210 style
- M Style: Milton or industrial style
- T Style: Tru-Flate/Parker Automotive style
- Light and durable nylon construction
- Maximum working pressure: 210 PSI

19305 - CARDED
 Master: 200 Inner: 10
 UPC: 8-02090-19305-0

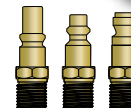

Fits A, M and T style fittings

1/4" x 25 Ft. Polyurethane Recoil Air Hose

- 1/4" NPT brass fittings with swivel-action, keep hose free of kinks
- **FIELD REPAIRABLE!**
- High visibility yellow color for a safer workplace
- Oil-proof and abrasion & corrosion resistant
- 120 PSI working pressure

19368 - CARDED
 Master: 40 Inner: 1
 UPC: 8-02090-19368-2



Swivel Action BRASS Nozzle Prevents Kinks



Polyurethane Air Hoses

- 1/4" NPT brass fittings with swivel-action to keep hose free of kinks
- Up to 50% lighter than standard rubber air hoses
- **FIELD REPAIRABLE!**
- Durable braided polyurethane construction with abrasion resistant finish

SPECIFICATIONS:

Temperature Range: -20 to 70° C (-4F to 165° F)
 Working Pressure: 200 PSI
 Burst Pressure: 800 PSI

1/4" x 25' HOSE
19365 - SHRINK WRAP
 Master: 20 Inner: 5
 UPC: 8-02090-19365-1

1/4" x 50' HOSE
19366 - SHRINK WRAP
 Master: 10 Inner: 5
 UPC: 8-02090-19366-8

1/4" x 100' HOSE
19367 - SHRINK WRAP
 Master: 10 Inner: 5
 UPC: 8-02090-19367-5



Swivel Action BRASS Nozzle Prevents Kinks

4" Air Blow Gun

- Variable air pressure control
- Allows for quick removal of dust, dirt particles from hard to reach places
- Durable plastic body and stainless steel nozzle
- Air inlet - 1/4" NPT
- Working pressure - 75 to 120 PSI
- Sound pressure - 85 to 90 db

19360 - CARDED

Master: 48 Inner: 12
UPC: 8-02090-19360-6



Pocket Blow Gun

- Variable air pressure control
- Allows for quick removal of dust, dirt particles from hard to reach places
- Durable plastic body and stainless steel nozzle

19380 - CARDED

Master: 80 Inner: 10
UPC: 8-02090-19380-4



Long Nozzle Air Blow Guns

- Variable air pressure control
- For quick removal of dust and dirt particles from hard to reach places
- Durable plastic body and steel nozzle with brass threaded air inlet

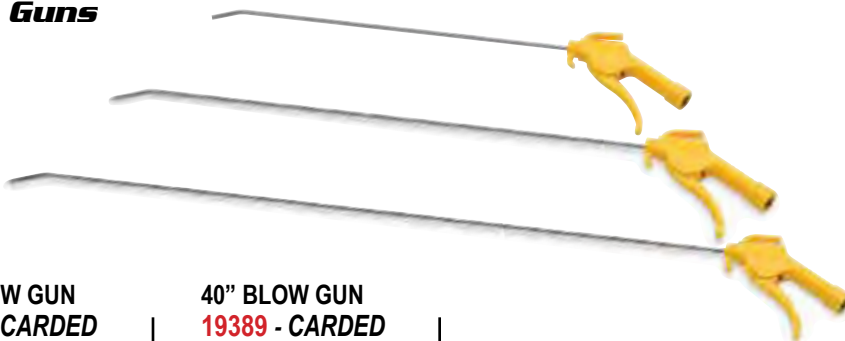

20" BLOW GUN

19387 - CARDED

Master: 48 Inner: 12
UPC: 8-02090-19387-3

30" BLOW GUN

19388 - CARDED

Master: 48 Inner: 12
UPC: 8-02090-19388-0

40" BLOW GUN

19389 - CARDED

Master: 48 Inner: 12
UPC: 8-02090-19389-7

Blow Gun Chip Shield

- Attaches to blow gun nozzle
- Keeps blow-back material out of operator's eyes
- Blow gun not included

19385 - CARDED

Master: 72 Inner: 12
UPC: 8-02090-19385-9

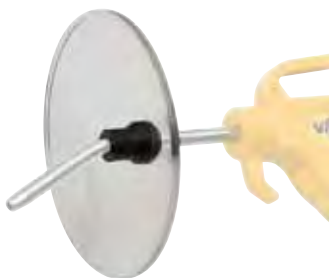

Inline Blow Gun

- Includes rubber safety tip
- 1/4" NPT Threads
- Ships in 8 pack counter display

19378 - COUNTER DISPLAY

Master: 48 Inner: 8
UPC: 8-02090-19378-1



Non-Aerosol Spot Sprayer

- 80-150psi operating pressure (max pressure: 200 psi)
- Refillable
- Not for use with paint products
- Eliminates dangerous, harmful propellants
- No more aerosol disposal issues
- Maximum capacity 32oz

19419 - DISPLAY BOX

Master: 20 Inner: 1
UPC: 8-02090-19419-1



**ECO
FRIENDLY!**

Sprayer Repair Kit

19420 - BOXED

Master: 1 Inner: 1



90 Amp Gasless Wire Feed Welder

- Easy-to-use gasless flux-core wire welder for the beginner
- Perfect for light duty repairs, maintenance and fabrication on light gauge steel around home, workshop and garage
- Welds up to 1/8" thick mild steel - not suitable for aluminum
- Operates on 120V single phase power - Amperage range: 60 - 90 amps
- Uses 0.030" to 0.035" diameter flux-core wire
- Thermal overload protector automatically shuts off welder when duty cycle is exceeded
- Fan cooled for better performance - One year limited warranty
- Includes: Welding shield, welding hammer/brush, sample spool of flux-core wire, earth clamp and welding cable



41185 - DISPLAY BOX

Master: 1 Inner: 1
UPC: 8-02090-41185-4

1/16" Fast Fill Welding Rod

- 1/2 pound of welding rod
- Works with all brands of 115 V welders
- Smooth bead with low spatter and fast deposition
- Ideal for general repair work
- Welds 18-ga to 1/8" mild steel

41230 - TUBE

Master: 80 Inner: 4
UPC: 8-02090-41230-1



General Purpose Welding Rods

- 1/2 pound of 5/64" welding rod
- Works with all brands of 115V welders
- 1/2 pound of 1/16" welding rod
- Works with all brands of welders

5/64" RODS

41231 - TUBE
Master: 80 Inner: 4
UPC: 8-02090-41231-8

1/16" RODS

41232 - TUBE
Master: 80 Inner: 4
UPC: 8-02090-41232-5



- 5 pounds of 1/8" welding rod
- Works with all brands of 230 V welders
- Smooth bead with low spatter and easy deposition
- Welds 18-ga to 1/8" mild steel for general purpose work

1/16" RODS

41237 - BOXED
Master: 10 Inner: 1
UPC: 8-02090-41237-0

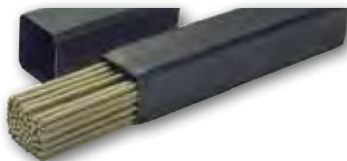

3/32" Brass Brazing Rod

- 3 rods - General purpose oxy-acetylene brazing rod
- Works with all brands of 230V welders - Flux coating, low fuming bronze
- For use on steel, copper alloys, cast iron, nickel alloys and stainless steel
- Use a neutral or slightly oxidizing flame to produce high strength, ductile weld deposits

41233 - TUBE

Master: 48 Inner: 4
UPC: 8-02090-41233-2



Deep Penetrating Welding Rods

- 1 LB of 1/8" welding rod
- 5 LB of 1/8" welding rod
- 5 LB of 3/32" welding rod
- Welds 1/8" to 3/8" rusted or dirty mild steel for general repair work
- Flat bead with deep penetrating arc - Works with all brands of 230V welders

1lb. of 1/8" RODS

41234 - TUBE
Master: 80 Inner: 4
UPC: 8-02090-41234-9

5lbs. of 1/8" RODS

41236 - BOXED
Master: 10 Inner: 1
UPC: 8-02090-41236-3



5lbs. of 3/32" RODS

41238 - BOXED
Master: 10 Inner: 1
UPC: 8-02090-41238-7

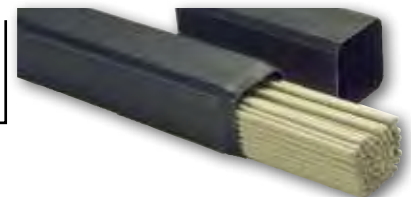

Item#	Description	AWS Classification	Operating Range in Amps	Welding Current AC	Welding Current DC+	Welding Current DC-	Min Power Source
41230	1/16" Fast Fill Welding Rods	7014***	35-70	x	x	x	115V 15A
41231	5/64" General Purpose Welding Rods	6013**	35-70	x	x	x	155V 20A
41232	1/16" General Purpose Welding Rods	6013**	25-50	x	x	x	115V 15A
41233	3/32" Brass Brazing Rods	RBCuZn-C	n/a	n/a	n/a	n/a	n/a
41234/41236	1/8" Deep Penetrating Welding Rods	6011*	80-130	x	x	x	230V 50A
41237	1/8" General Purpose Welding Rods	6013**	80-130	x	x	x	230V 50A
41238	3/32" Deep Penetrating Welding Rods	6011*	60-90	x	x	x	115V 15A

*6011: Deep penetration rod used primarily with AC power sources. **6013: Great general purpose rod that works great AC/DC, Works especially great on low voltage AC. Has shallow penetration making excellent choice for sheet metal work. ***7014: Fast-freeze characteristics and high deposition travel Speeds. AC/DC rod

Tip Cleaner

- Use to clean spatter and debris from oxy-fuel welding tips
- Includes 13 tip cleaners and one file

41223 - CARDED

Master: 240 Inner: 24
UPC: 8-02090-41223-3

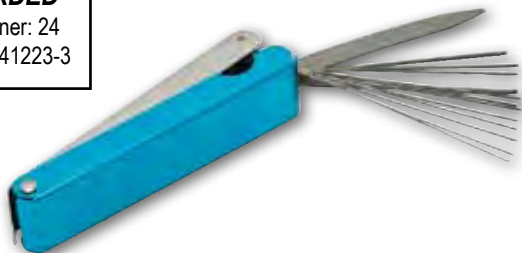

Chipping Hammer

- Use to chip and remove slag from welds
- Coiled spring handle helps absorb shock while chipping

41225 - CARDED

Master: 48 Inner: 6
UPC: 8-02090-41225-7



MIG Wire Utility Pliers

- Needle nose pliers and wire cutter for pulling and trimming MIG wire
- Sharp edges for cleaning inside nozzle and around tips
- Small serrated hole for MIG tips
- Large serrated hole for nozzles
- Spring loaded handle with heavy insulated grip for comfort

11448 - CARDED

Master: 36 Inner: 6
UPC: 8-02090-11448-9



Contact Tips - 4 Pack

- Comes in 0.024", 0.030" and 0.035" contact tips

.030" Tip

41250 - CARDED

Master: 480 Inner: 40
UPC: 8-02090-41250-9

.035" Tip

41251 - CARDED

Master: 480 Inner: 40
UPC: 8-02090-41251-6



Magnetic Welding Support Jigs

- Multi-purpose magnetic holder, ideal for holding objects while tack-welding, soldering & installing pipe
- Strong magnet holds materials at 45, 90 and 135 degree angles

MEDIUM - Holds up to 50lbs.
6-1/4" x 4"

41292 - CARDED

Master: 24 Inner: 6
UPC: 8-02090-41292-9

SMALL - Holds up to 25lbs.
4-3/4" x 3-1/4"

41291 - CARDED

Master: 60 Inner: 10
UPC: 8-02090-41291-2

LARGE - Holds up to 75lbs.
7-1/2" x 4-13/16"

41293 - CARDED

Master: 20 Inner: 5
UPC: 8-02090-41293-6

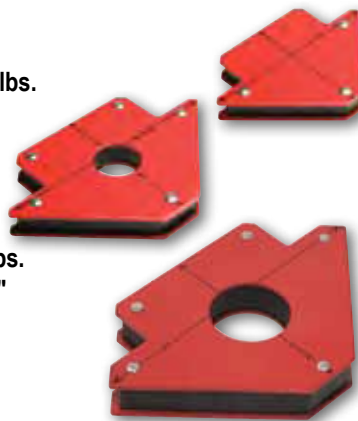

Welding Nozzle

- Wire feed replacement nozzle

41252 - CARDED

Master: 480 Inner: 40
UPC: 8-02090-41252-3



Aluminum Wire - .030"

- 1 pound roll

41244 - SHRINK WRAP

Master: 20 Inner: 1
UPC: 8-02090-41244-8



Flux Core Wire

- 2 pound roll

.030" WIRE

41242 - SHRINK WRAP

Master: 20 Inner: 1
UPC: 8-02090-41242-4

.035" WIRE

41245 - SHRINK WRAP

Master: 20 Inner: 1
UPC: 8-02090-41245-5



MIG Wire

- 2 pound roll

.030" WIRE

41240 - SHRINK WRAP

Master: 20 Inner: 1
UPC: 8-02090-41240-0

.035" WIRE

41241 - SHRINK WRAP

Master: 20 Inner: 1
UPC: 8-02090-41241-7

.024" WIRE

41243 - SHRINK WRAP

Master: 20 Inner: 1
UPC: 8-02090-41243-1



Brazing Goggles

- Soft vinyl frame for comfort
- Lightweight, deep frame accommodates safety glasses
- Shade #5 lens offers protection from harmful rays

41235 - CARDED
Master: 120 Inner: 12
UPC: 8-02090-41235-6



Welding Gloves

- Premium Leather
- Fleece Lined

41239 - CARDED
Master: 60 Inner: 12
UPC: 8-02090-41239-4



Soap Stone Holder

- Pen type holder includes collet-style clamp with pocket clip and built-in sharpener
- Includes one round soapstone marker
- White lines are visible through shaded welding lens
- Use to mark and outline weld areas on steel and other alloys

41222 - CARDED
Master: 240 Inner: 24
UPC: 8-02090-41222-6



Replacement Soap Stone

- Use to mark and outline weld areas on steel and other alloys
- White lines are visible through shaded welding lens
- Includes six soapstones

41221 - CARDED
Master: 240 Inner: 24
UPC: 8-02090-41221-9



Flint Lighter

- Single flint lighter for oxy-fuel torches

41224 - CARDED
Master: 240 Inner: 24
UPC: 8-02090-41224-0

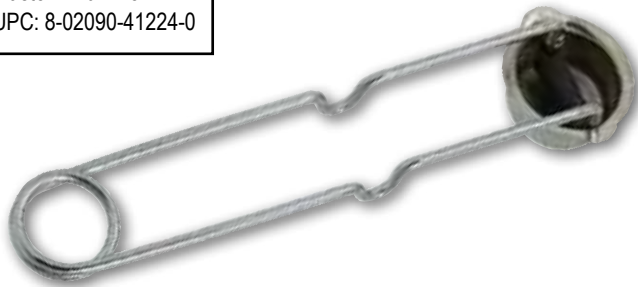

Replacement Flints

- Includes 5 flints

41253 - CARDED
Master: 480 Inner: 60
UPC: 8-02090-41253-0

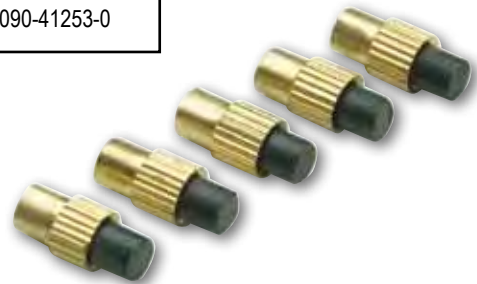

Small Brass Wire Brushes

- Brass bristles ideal for cleaning aluminum welds
- Small size fits into tight corners
- Angle handle helps protect knuckles

41226 - CARDED
Master: 360 Inner: 36
UPC: 8-02090-41226-4

41227 - CARDED
Master: 360 Inner: 36
UPC: 8-02090-41227-1



11 Amp 7" Polisher / Sander

- 3000 RPM, 11 Amp Motor - 120V 60 Hz
- Interchangeable D-handle and side handle
- Adjustable dial speed control
- Lock-on switch for comfort during extended use
- Auxiliary handle mounts either side for left or right-hand use
- Includes (1) D-handle & (1) side handle, hook & loop disk, polishing bonnet, and rubber pad

22707 - DISPLAY BOX

Master: 4 Inner: 1
UPC: 8-02090-22707-3



MOTOR BRUSHES

22707-01
Master: 4 Inner: 1

TRIGGER

22707-02
Master: 4 Inner: 1

6" Random Orbital Buffer / Polisher

- Powerful 0.40 Amp, 3500 RPM motor
- Random action reduces paint burn-through
- Lightweight for easy one-hand operation
- Includes 1 terrycloth bonnet and 1 synthetic wool bonnet

22606 - DISPLAY BOX

Master: 6 Inner: 1
UPC: 8-02090-22606-9



Heat Gun

- Ideal for plastic welding shrink tubing and paint stripping
- Dual temperature setting
- 3 position rocker switch: off, high, & low
- Durable ABS body
- Double insulated
- 6-1/2 ft cord

22400 - DISPLAY BOX

Master: 10 Inner: 1
UPC: 8-02090-22400-3



10" Random Orbital Buffer / Polisher

- Powerful 0.92 Amp, 3000 RPM motor
- Random action reduces paint burn-through
- Lightweight with large, comfortable handles
- Includes 1 terrycloth bonnet and 1 synthetic wool bonnet

22610 - DISPLAY BOX

Master: 6 Inner: 1
UPC: 8-02090-22610-6



7" Replacement Rubber Polishing Pad

- Replacement rubber pad for Vaper item 22507
- Fits a 5/8"-11 spindle thread

22508 - CARDED
 Master: 25 Inner: 1
 UPC: 8-02090-22508-6



7" Replacement Velcro Sanding Pad

- Replacement velcro pad for Vaper item 22507
- Fits a 5/8"-11 spindle thread

22509 - CARDED
 Master: 25 Inner: 1
 UPC: 8-02090-22509-3



7-1/2" Wool Buffing Pad

- Cleans and removes defects on paint
- For use on cars, trucks, boats, rv's, etc
- 100% Wool
- 7-1/2" x 1-1/2"

22516 - CARDED
 Master: 36 Inner: 1
 UPC: 8-02090-22516-1



Foam Velcro Buffing Pad

- Cleans and removes defects on paint
- Fits standard size Velcro back plates
- For use on cars, trucks, boats, rv's, etc.

22515 - CARDED
 Master: 36 Inner: 1
 UPC: 8-02090-22515-4



2 pc 6" Replacement Bonnets

- For use on 6" buffers and polishers
- Includes 1 terrycloth bonnet for applying waxes and 1 synthetic wool bonnet for fine buffing and polishing

22502 - CARDED
 Master: 100 Inner: 10
 UPC: 8-02090-22502-4



10" Replacement Application and Buff Bonnets

- For use on 10" buffers and polishers
- Includes 1 terrycloth bonnet for applying waxes and 1 synthetic wool bonnet for fine buffing and polishing

22501 - CARDED
 Master: 100 Inner: 10
 UPC: 8-02090-22501-7



5/8" x 11" Flange Nut and Wrench Set

- Replacement Flange Nut for Vapor #22507 and #25777
- Also fits other polishers and grinders with 5/8"
- 11 spindle threads

22511 - CARDED
 Master: 36 Inner: 6
 UPC: 8-02090-22511-6



Bonnet Cleaning Tool

- Extends the life of buffing pads while still attached to the polisher
- Fluffs packed wool and removes glazed surface
- Quickly and easily restores bonnets and pads to like new condition

22518 - CARDED
 Master: 72 Inner: 12
 UPC: 8-02090-22518-5



1.4mm HVLP

Gravity Feed Spray Gun

- Gravity feed design provides for easy clean up and reliable performance
- Unlike siphon feed guns, gravity feed guns ensure virtually 100% material usage
- Lightweight aluminum paint cup
- Stainless steel needle and nozzle set resists corrosion and wear from abrasive materials
- Infinitely adjustable fluid control for precise paint metering
- Spray pattern control allows adjustment from round to full-fan shape
- Air valve for precise air flow adjustment
- Includes pressure regulator and cleaning kit

19014 - BOXED

Master: 5 Inner: 1

UPC: 8-02090-19014-8



3" Air Cut-Off Tool

- Ideal for cutting sheet metals, fiberglass, bolts, muffler clamps etc.
- No-load speed: 18,000 RPM
- Includes 3" abrasive wheel, arbor wrench and allen wrench

19703 - BOXED

Master: 5 Inner: 1

UPC: 8-02090-19703-1



Cut Off Tool Rebuild Kit

- Contents Includes:
- (1) Valve Stem Seat (4) O-Ring
- (1) Pin (1) Spring
- (1) Air Regulator (4) Rotor Blade

19703-01 - POLYBAG

Master: 1 Inner: 1

UPC: 8-02090-00036-2



20 pc Air Die Grinder Kit

- 1 Straight die grinder - 1 Angle die grinder
- 10 Assorted grinding stones - 2 Connectors
- 1 Collet - 4 Wrenches - Blow mold case

19701 - BOXED

Master: 5 Inner: 1

UPC: 8-02090-19701-7



Die Grinder Rebuild Kit

- Contents Includes:
- (1) Valve Bushing (4) O-Ring (1) Valve Stem (1) Spring
- (1) Air Regulator (4) Rotor Blade (1) Chuck

19701-01 - POLYBAG

Master: 1 Inner: 1

UPC: 8-02090-00040-9

Air Die Grinder

- Ideal for light duty metal fabrication, grinding, porting and polishing applications
- Durable, lightweight composite housing design helps reduce vibration
- Lever lock throttle for safety.
- 1/4" Collet - Includes 2 collet wrenches

19704 - BOXED
 Master: 20 Inner: 1
 UPC: 8-02090-19704-8



Die Grinder Rebuild Kit

- Contents Includes:
- (4) O-Ring
- (1) Compass Spring
- (4) Rotor Blade
- (1) Chuck

19704-01 - POLYBAG
 Master: 1 Inner: 1
 UPC: 8-02090-00038-6

1/2" Air Impact Wrench

- Die cast aluminum body with rubber scuff guards on nose and back
- Reversible - Built-in air regulator varies speed & power
- Front exhaust - Max torque: 230 ft/lbs (310 N/m)

19706 - BOXED
 Master: 5 Inner: 1
 UPC: 8-02090-19706-1



1/2" Dr. Air Impact Gun Rebuild Kit

- Contents Includes:
- (3) O-Ring (1) Oil Seal
- (6) Rotor Blade (4) Washer
- (4) Bolt (1) Inlet Spring
- (1) Spring

19706-01 - POLYBAG
 Master: 1 Inner: 1
 UPC: 8-02090-00039-3

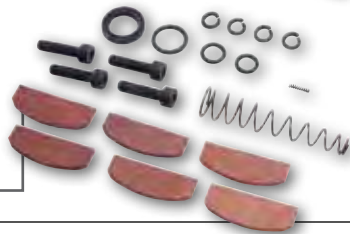

3/8" Air Ratchet

- Forward/reverse lever conveniently located for quick direction changes
- Front exhaust blows debris away from work area.
- Compact head design allows access to confined areas
- Max torque: 45ft/lb (68N/m)

19707 - BOXED
 Master: 20 Inner: 1
 UPC: 8-02090-19707-9



3/8" Dr. Air Ratchet Rebuild Kit

- (1) Roll Pin (1) Trigger (4) Rotor Blade (3) Idler Gear
- (3) Idler Gear Pin (1) Crank Shaft (1) Drive Bushing O-Rings

19707-01 - POLYBAG
 Master: 1 Inner: 1
 UPC: 8-02090-00041-6

Air Hammer

- Hardened steel barrel & piston
- Lightweight aluminum pistolgrip housing
- Front exhaust
- Includes the 4 most popular chisels
- 4,500 blows per minute

19709 - BOXED
 Master: 5 Inner: 1
 UPC: 8-02090-19709-3



Air Hammer Rebuild Kit

- Contents Includes: (3) O-Ring, (1) Clamp Screw, (1) Spring, (1) Switch Pin

19709-01 - POLYBAG
 Master: 1 Inner: 1
 UPC: 8-02090-00037-9



Air Hammer Retainer Spring

- Replacement retainer spring for item 19709

19710 - POLYBAG
 Master: 5 Inner: 1
 UPC: 8-02090-19710-9



3/8" Filter

- Maintains steady outlet pressure, unaffected by variations / fluctuations in the inlet pressure
- Aluminum die cast construction with a Non raising "Press to Lock" adjusting knob for locking at any set pressure
- Can be installed in any position (horizontal / vertical etc.)
- Modular mounting systems allows for removal of components without disturbing the pipe line

19297 - BOXED

Master: 30 Inner: 1
UPC: 8-02090-19297-5



3/8" Regulator

- Maintains steady outlet pressure, unaffected by variations / fluctuations in the inlet pressure
- Aluminum die cast construction with a Non raising "Press to Lock" adjusting knob for locking at any set pressure
- Can be installed in any position (horizontal / vertical etc.)
- Modular mounting systems allows for removal of components without disturbing the pipe line

19296 - BOXED

Master: 50 Inner: 1
UPC: 8-02090-19296-8



3/8" Filter-Regulator

-Lubricators

- Maintains steady outlet pressure, unaffected by variations / fluctuations in the inlet pressure
- Aluminum die cast construction with a Non raising "Press to Lock" adjusting knob for locking at any set pressure
- Can be installed in any position (horizontal / vertical etc.)
- Modular mounting systems allows for removal of components without disturbing the pipe line

19298 - BOXED

Master: 15 Inner: 1
UPC: 8-02090-19298-2



1/2" Filter-Regulator

- Maintains steady outlet pressure, unaffected by variations / fluctuations in the inlet pressure
- Aluminum die cast construction with a Non raising "Press to Lock" adjusting knob for locking at any set pressure
- Can be installed in any position (horizontal / vertical etc.)
- Modular mounting systems allows for removal of components without disturbing the pipe line

19299 - BOXED

Master: 18 Inner: 1
UPC: 8-02090-19299-9



1/2" Filter-Regulator-Lubricators

- Maintains steady outlet pressure, unaffected by variations / fluctuations in the inlet pressure
- Aluminum die cast construction with a Non raising "Press to Lock" adjusting knob for locking at any set pressure
- Can be installed in any position (horizontal / vertical etc.)
- Modular mounting systems allows for removal of components without disturbing the pipe line

19301 - BOXED

Master: 10 Inner: 1
UPC: 8-02090-19301-9



1/2" Filter

- Maintains steady outlet pressure, unaffected by variations / fluctuations in the inlet pressure
- Aluminum die cast construction with a Non raising "Press to Lock" adjusting knob for locking at any set pressure
- Can be installed in any position (horizontal / vertical etc.)
- Modular mounting systems allows for removal of components without disturbing the pipe line

19300 - BOXED

Master: 16 Inner: 1
UPC: 8-02090-19300-2



1/4" Filter-Regulator-Lubricators

- Maintains steady outlet pressure, unaffected by variations / fluctuations in the inlet pressure
- Aluminum die cast construction with a Non raising "Press to Lock" adjusting knob for locking at any set pressure
- Can be installed in any position (horizontal / vertical etc.)
- Modular mounting systems allows for removal of components without disturbing the pipe line

19306 - BOXED

Master: 25 Inner: 1
UPC: 8-02090-19306-4



1/4" Filter-Regulator-Lubricators

- Maintains steady outlet pressure, unaffected by variations / fluctuations in the inlet pressure
- Aluminum die cast construction with a Non raising "Press to Lock" adjusting knob for locking at any set pressure
- Can be installed in any position (horizontal / vertical etc.)
- Modular mounting systems allows for removal of components without disturbing the pipe line

19307 - BOXED

Master: 20 Inner: 1
UPC: 8-02090-19307-1



1/4" Filter

- Steady outlet pressure, unaffected by variations/fluctuations in the inlet pressure
- Aluminum die cast construction with a Non raising "Press to Lock" adjusting knob for locking at any set pressure
- Can be installed in any position (horizontal / vertical etc.)
- Modular mounting systems allows for removal of components without disturbing the pipe line

19308 - BOXED

Master: 40 Inner: 1
UPC: 8-02090-19308-8



1/4" Regulator

- Maintains steady outlet pressure, unaffected by variations / fluctuations in the inlet pressure
- Aluminum die cast construction with a Non raising "Press to Lock" adjusting knob for locking at any set pressure
- Can be installed in any position (horizontal / vertical etc.)
- Modular mounting systems allows for removal of components without disturbing the pipe line

19309 - BOXED

Master: 60 Inner: 1
UPC: 8-02090-19309-5



Male Ball Foot Chuck

- 1/4" (6,3mm) NPT (M)

19321 - CARDED

Master: 192 Inner: 12
UPC: 8-02090-19321-7



4 pc Air Inflater Kit

- Includes inflation adapter, tapered inflation nozzle, inflation needle, and tire nozzle

19356 - CARDED

Master: 96 Inner: 24
UPC: 8-02090-19356-9



Female Ball Foot Chuck

- 1/4" NPT (F)

19323 - CARDED

Master: 192 Inner: 12
UPC: 8-02090-19323-1



2 pc Female Plugs

- (2) 1/4" NPT Female
- Quick-connect fittings

19325 - CARDED

Master: 192 Inner: 12
UPC: 8-02090-19325-5



2 pc Male Plugs

- (2) 1/4" NPT Male
- Quick-connect fittings

19322 - CARDED

Master: 192 Inner: 12
UPC: 8-02090-19322-4



Dual Head Tire Chuck

- 1/4" NPT Female
- 6" overall length
- Offset dual head

19324 - CARDED

Master: 96 Inner: 12
UPC: 8-02090-19324-8

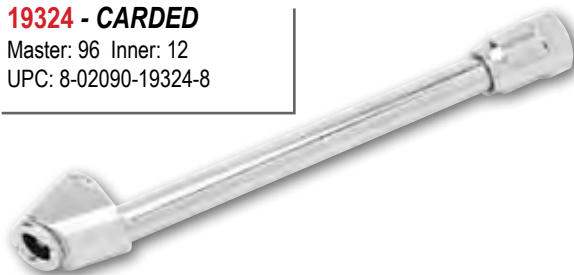

Air Line Couplers

- Attaches to end of air hose to connect to air tools and accessories equipped with plugs

19326 1/4" NPT Female - CARDED

Master: 192 Inner: 12
UPC: 8-02090-19326-2

19343 1/4" NPT Male - CARDED

Master: 192 Inner: 12
UPC: 8-02090-19343-9



Swivel Plug

- 1/4" (6,3mm) NPT (M)
- 30° Swivel action reduces fatigue by increasing mobility at the tool
- Swivel feature for easy access in confined spaces

19327 - CARDED

Master: 120 Inner: 20
UPC: 8-02090-19327-9



4 pc Quick Connector Kit

- Includes 1/4" NPT:
- Steel female coupler
- Male plug
- Female plug
- Double male connector

19330 - CARDED

Master: 96 Inner: 12
UPC: 8-02090-19330-9



5 pc Coupler and Plug Set

- Includes 1/4" NPT:
- Steel female coupler
- (4) Male plugs

19333 - CARDED

Master: 48 Inner: 6
UPC: 8-02090-19333-0



Female Air Chuck with Clip

- 1/4" NPT (F)
- Handy clip holds chuck on tire valve until released

19334 - CARDED
 Master: 192 Inner: 12
 UPC: 8-02090-19334-7



Tire Inflator/Dial Gauge

- 1/4" NPT (F)
- 0 - 160 PSI
- Locking chuck

19344 - CARDED
 Master: 24 Inner: 6
 UPC: 8-02090-19344-6



5 pc 3" Cut Off Wheels

- 3" diameter x 1/16" thick
- Fits standard 3/8" spindle
- 25,000 RPM rating
- For use with Vaper #19703 Cut-Off Tool and other similar models

19336 - CARDED
 Master: 192 Inner: 12
 UPC: 8-02090-19336-1



7 pc Blow Gun Kit

- Blow gun with 6 accessory attachments:
- 3-3/4" extension, Rubber tip
- Sports ball inflator and adaptor
- Inflatable toy inflator and safety adaptor

19337 - CARDED
 Master: 36 Inner: 6
 UPC: 8-02090-19337-8



17 pc Air Accessory Kit

- Blow Gun - (2) 1/4" NPT brass double male connectors
- 1/4" NPT double female connector
- 6" offset dual-head tire chuck - Tire pressure gauge
- 1/4" NPT Brass female coupler
- (2) 1/4" NPT female plugs - (4) 1/4" NPT male plugs
- Sports ball inflator and adaptor - Inflatable toy inflator and safety adaptor

19338 - CARDED
 Master: 24 Inner: 6
 UPC: 8-02090-19338-5



Air Line Inflator Gauge

- 1/4" NPT (M)
- 10 - 120 PSI gauge
- Dual foot chuck

19341 - CARDED
 Master: 24 Inner: 6
 UPC: 8-02090-19341-5



3/8" Hose Mender

- Repairs 3/8" I.D. hose
- 2 double end brass hose fittings
- 4 hose clamps

19345 - CARDED
 Master: 192 Inner: 12
 UPC: 8-02090-19345-3



3/8" Hose Ends, 1/4" NPT

- Repairs 3/8" I.D. air hose

19346 - CARDED
 Master: 192 Inner: 12
 UPC: 8-02090-19346-0



NEW PRODUCTS



5 pc Grinding Stone Set

- 5 assorted grinding stones for Vaper 19701 die grinders and similar models with 1/4" collets
- Rated for 25,000 RPM

19352 - CARDED

Master: 72 Inner: 12
UPC: 8-02090-19352-1



4 pc Air Chisel Set

- Assortment of the 4 most popular chisels for Vaper 19709 Air Hammer and other similar models with .401" bores
- 4-3/4" overall length
- Bushing splitter, weld buster, ripping chisel & tapered punch

19355 - CARDED

Master: 36 Inner: 6 UPC: 8-02090-19355-2



Air Adjusting Valve with Gauge

- 0 to 140 PSI gauge
- 1/4" NPT Male and female fittings

19359 - CARDED

Master: 48 Inner: 6
UPC: 8-02090-19359-0



Double Male Connector

- 1/4" NPT Male adapter allows 2 Female accessories to be connected

19361 - CARDED

Master: 192 Inner: 12
UPC: 8-02090-19361-3



3/8" x 50' PVC Air Hose

- Resists gasoline, oil and other automotive liquids
- Premium grade hose with bend restrictors at each end for prolonged life
- Includes 1/4" NPT male fittings at each end
- Working pressure: 300 PSI
- Burst pressure: 1,200 PSI

19371 - SHRINK WRAP

Master: 6 Inner: 1
UPC: 8-02090-19371-2



3/8" x 50' Hybrid Air Hose

- Blended rubber and PVC hose is extremely light weight and flexible
- Bend restrictors at each end for prolonged life
- Includes 1/4" NPT male fittings at each end
- Working pressure: 300 PSI
- Burst pressure: 1,200 PSI

19377 - SHRINK WRAP

Master: 6 Inner: 1
UPC: 8-02090-19377-4



3/8" x 50' Rubber Air Hose

- Working pressure: 300PSI
- Burst pressure: 1,200 PSI
- 3/8" Brass Fittings
- Vinyl kink Restrictors

19376 - SHRINK WRAP

Master: 5 Inner: 1
UPC: 8-02090-19376-7



3/8" x 50' Rubber Air Hose

- Working Pressure: 300psi
- Burst Pressure: 1,200psi
- 3/8" Brass Fittings
- Vinyl Kink Restrictors

19382 - SHRINK WRAP

Master: 5 Inner: 1
UPC: 8-02090-19382-8



Snub Nose Safety Blow Gun

- Protective snub nose, stainless steel nozzle
- 1/4" NPT (F) - Soft molded rubber grip
- Variable speed trigger
- Nylon body, threaded brass insert

19397 - CARDED

Master: 120 Inner: 10
UPC: 8-02090-19397-2



4-1/4" Professional Safety Blow Gun

- Vented tip, stainless steel nozzle
- 1/4" NPT (F) - Soft molded rubber grip
- Variable speed trigger
- Nylon body, threaded brass insert

19398 - CARDED

Master: 60 Inner: 10
UPC: 8-02090-19398-9



Low Noise Safety Blow Gun

- Noise reduced, stainless steel nozzle
- 1/4" NPT (F) - Soft molded rubber grip
- Variable speed trigger
- Nylon body, threaded brass insert

19399 - CARDED

Master: 60 Inner: 10
UPC: 8-02090-19399-6



Venturi Blow Gun

- Venturi Tip Allows for 4X the pressure - Lightweight and durable - 1/4" NPT
- Working Pressure: 90-120 psi/ 6.0-8.0 kg \bar{i}
- Max Pressure: 220 psi / 15 kg - Sound Pressure: 90 ~ 92 dB
- Air Consumption (90 psi):^om Hose-13
- CFM-350L/min 3/8" Hose-15 CFM-430 L/min
- Air Inlet Thread: SAE Size (1/4" NPT), MM Size (1/4" PT)

19402 - CARDED

Master: 36 Inner: 6
UPC: 8-02090-19402-3



Air Gun & Wand

- Zinc Alloy Gun with aluminum nozzle
- 30 degree angled nozzle
- Air inlet: 1/4" NPT - Rubber Tip

19992 24" - POLYBAG

Master: 40 Inner: 10 UPC: 8-02090-19992-9

19993 36" - POLYBAG

Master: 40 Inner: 10 UPC: 8-02090-19993-6

19994 48" - POLYBAG

Master: 40 Inner: 10 UPC: 8-02090-19994-3



Spot Spray Non-Aerosol Sprayer - Twin Pack

- 80-150psi operating pressure (max pressure: 200 psi)
- Refillable - Not for use with paint products
- Eliminates dangerous or harmful propellants
- No more aerosol disposal issues
- Eco friendly - Maximum capacity 32oz

19421 - BOXED

Master: 10 Inner: 1
UPC: 8-02090-19421-4



1/2" Dr. Electric Impact Wrench

- 120V/60Hz, 7.5 amp motor
- Rocker switch for easy one hand reversing & forwarding
- 185 ft-lbs max torque
- 2,100 RPM no load speed
- 6 ft cord

22152 - BOXED

Master: 4 Inner: 1
UPC: 8-02090-22152-1



Triple Flint Lighter

- Easy-to-use triple flint lighter
- Ideal for lighting oxy-fuel torches
- Uses Vaper replacement flints #41258

41257 - COLOR LABEL

Master: 240 Inner: 24
UPC: 8-02090-41257-8



Replacement Flint

41258 - CARDED

Master: 480 Inner: 60
UPC: 8-02090-41258-5



11 AMP 7" Polisher

- Adjustable dial speed control - Lock-on switch for extended use
- Auxiliary handle mounts either side for left or right-hand use
- Includes velcro pad for sandpaper, and rubber pad for polishing bonnet

22504 - BOXED

Master: 4 Inner: 1
UPC: 8-02090-22504-8



SHOP IRON PRODUCTS

SHOP IRON PRODUCTS



This Section Includes:

BENCH VISES

LUG NUT WRENCHES

5" Bench Vise

- Hardened steel jaws
- Precision cast iron beam
- Replaceable jaws - Incorporated anvil
- Swivel base with position lock

22013 - BOXED

Master: 1 Inner: 1
UPC: 8 02090 22013 5



Replacement Jaw

22006 - BULK

Master: 1 Inner: 1
UPC: 8 02090 22006 7

4" Bench Vise

- Hardened Steel Jaws - Precision cast iron beam
- Replaceable jaws - Incorporated anvil
- Swivel base with position lock

22010 - BOXED

Master: 1 Inner: 1
UPC: 8 02090 22010 4



Replacement Jaw

22003 - BULK

Master: 1 Inner: 1
UPC: 8 02090 22003 6

4" Bench Vise

- Professional Grade - Forged Steel Beam
- Replaceable hardened steel jaws
- Serrated pipes jaws
- Incorporated anvil
- Swivel base with position lock

Professional Grade

22011 - BOXED

Master: 1 Inner: 1
UPC: 8 02090 22011 1



Replacement Jaw

22004 - BULK

Master: 1 Inner: 1
UPC: 8 02090 22004 3

5" Swivel Vise

- Hardened steel jaws rotate 360 degrees
- Jaws rotate for clamping at any angle
- Precision cast iron beam
- Replaceable jaws - Incorporated anvil
- Serrated pipe jaws

22012 - BOXED

Master: 1 Inner: 1
UPC: 8 02090 22012 8



Replacement Jaw

22005 - BULK

Master: 1 Inner: 1
UPC: 8 02090 22005 0

5" Bench Vise

- Professional Grade - Forged steel beam
- Replaceable hardened steel jaws
- Serrated pipe jaw - Incorporated anvil
- Swivel base with lock position

Professional Grade

22014 - BOXED

Master: 1 Inner: 1
UPC: 8 02090 22014 2



Replacement Jaw

22007 - BULK

Master: 1 Inner: 1
UPC: 8 02090 22007 4

6" Bench Vise

- Hardened steel jaws - Precision cast iron beam
- Replaceable jaws - Incorporated anvil
- Swivel base with position lock

22015 - BOXED

Master: 1 Inner: 1
UPC: 8 02090 22015 9



Replacement Jaw

22008 - BULK

Master: 1 Inner: 1
UPC: 8 02090 22008 1

6" Bench Vise

- Professional Grade - Hardened steel jaws
- Forged steel beam - Replaceable hardened steel jaws
- Serrated pipe jaws - Incorporated anvil
- Swivel base with position lock

Professional Grade

22016 - BOXED

Master: 1 Inner: 1
UPC: 8 02090 22016 6



Replacement Jaw

22009 - BULK

Master: 1 Inner: 1
UPC: 8 02090 22009 8



14" Lug Wrench - SAE/MM

- Carbon Steel
- chrome polish
- Sizes include:
17, 19, 21, 23MM
11/16", 3/4", 13/16", 7/8"
- Sizes stamped

21080 - Bulk

Master: 1 Inner: 12
UPC: 8 02090 21080 8



14" Folding Lug Wrench - SAE/MM

- Carbon Steel
- chrome polish
- Sizes include:
17, 19, 21, 23MM
11/16", 3/4", 13/16", 7/8"
- Sizes stamped

21081 - Bulk

Master: 1 Inner: 12
UPC: 8 02090 21081 5

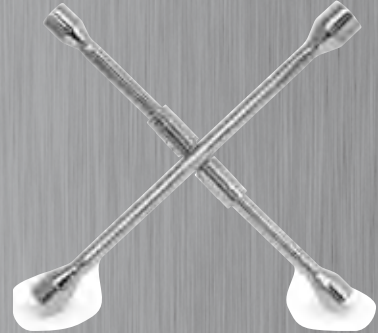

20" Lug Wrench - SAE/MM

- Carbon Steel
- chrome polish
- Sizes include:
17, 19, 21, 23MM
11/16", 3/4", 13/16", 7/8"
- Sizes stamped

21082 - Bulk

Master: 1 Inner: 12
UPC: 8 02090 21082 2



22" Universal 4-Way Lug Wrench

- Carbon Steel
- chrome polish
- Sizes include:
22, 24, 26, 27MM
1-1/16", 1", 15/16", 7/8"
- Sizes stamped

21086 - Hang Pouch

Master: 1 Inner: 6
UPC: 8 02090 21086 0





This Section Includes:

MECHANIC'S TOOLS

HAND TOOLS

GENERAL TOOLS / SERVICE KITS

WELDING

NEW TEKZ PRODUCTS

TEKZ PRODUCTS

22 pc Raised Panel SAE / Metric Wrench Set

- Chrome vanadium steel construction
- Drop forged for added strength and durability
- Polished chrome plated finish
- Includes storage pouch
- Contains 1/4 to 7/8" and 8 to 18mm wrenches



17322 - DISPLAY BOX

Master: 4 Inner: 1
UPC: 8-02090-17322-6

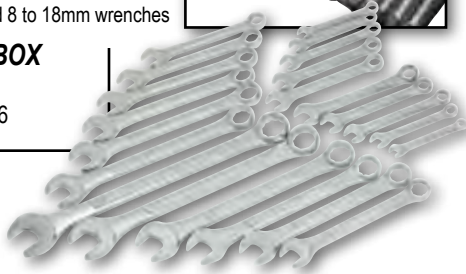

5 pc Combination Wrench Sets

- Drop forged steel construction - Flat panel design
- Handy storage pouch

SAE Set: 3/8, 7/16, 1/2, 9/16 & 5/8"

17384 - POUCH

Master: 48 Inner: 6
UPC: 8-02090-17384-4

Metric Set: 10, 12, 13, 14 & 15mm

17385 - POUCH

Master: 48 Inner: 6
UPC: 8-02090-17385-1



9 pc Combination Wrench Sets

- Chrome vanadium steel
- Reusable storage rack

SAE Set: 5/16, 3/8, 7/16, 1/2, 9/16, 5/8, 11/16, 3/4 and 7/8"

17394 - HANG TAB

Master: 20 Inner: 5
UPC: 8-02090-17394-3

Metric Set: 10, 11, 12, 13, 14, 15, 16, 17, 18mm

17395 - HANG TAB

Master: 20 Inner: 5
UPC: 8-02090-17395-0



7 pc SAE Stubby Combination Wrench Set

- SAE Sizes: 3/8, 7/16, 1/2, 9/16, 5/8, 11/16, & 3/4"
- Compact wrenches fit inside confined areas
- Chrome vanadium steel construction
- Packed on handy storage rack

17370 - HANG TAB

Master: 24 Inner: 6
UPC: 8-02090-17370-7



7 pc METRIC Stubby Combination Wrench Set

- Metric Sizes: 10, 11, 12, 13, 14, 15, & 18mm
- Compact wrenches fit inside confined areas
- Chrome vanadium steel construction
- Packed on handy storage rack

17371 - HANG TAB

Master: 24 Inner: 6
UPC: 8-02090-17371-4



30 pc Standard and Stubby Combination Wrench Set

- Full-size wrenches: 1/4, 5/16, 3/8, 7/16, 1/2, 9/16, 5/8, 3/4, 7/8" and 10, 11, 12, 13, 14, 15, 16, 17, 18 mm
- Stubby wrenches: 3/8, 7/16, 1/2, 9/16, 5/8, 11/16" and 10, 11, 12, 13, 14, 15 mm
- Chrome vanadium steel
- Reusable storage racks

17399 - HANG TAB

Master: 8 Inner: 2
UPC: 8-02090-17399-8



75 pc SAE / Metric Combination Socket Set

- 3/8" and 1/2" drive reversible ratchets
- 3/8" dr. accessories: Spin Disc, 3" Extension, 1/4" adaptor, coupler, 5/8" Spark Plug Socket
- 12 SAE & Metric 3/8" dr. sockets
- 31 SAE & Metric 1/4" dr. sockets
- 4 SAE 1/2" dr. sockets
- 1/4" dr. Spinner Handle
- 8 Hex Keys
- 11 Power bits & holder
- Blow Molded Case



18194 - DISPLAY BOX

Master: 5 Inner: 1
UPC: 8-02090-18194-8

21 pc SAE / Metric 1/4" Dr. Socket Set

- 1/4" drive ratchet
- 10 Inch sizes: 5/32, 7/32, 1/4, 9/32, 5/16, 11/32, 3/8, 7/16, 15/32 and 1/2"
- 10 Metric sizes: 4, 5, 6, 7, 8, 9, 10, 11, 12 and 13mm
- Fully polished and chrome plated
- Bonus storage rack included



18180 - HANG TAB

Master: 24 Inner: 6
UPC: 8-02090-18180-1

52 pc Socket Set

- Carbon steel construction
- 1/2" Dr. SAE sockets & ratchet handle
- 3/8" Dr. SAE & Metric sockets & ratchet handle
- 5/8" Spark plug socket, 3" Extension bar, Spin disc
- 1/4" Dr. SAE & Metric Sockets + 8 pt sockets
- Screwdriver bits: Slotted and Phillips
- 1/4" x 3/8" dr adapter, Coupler & spinner handle



18198 - DISPLAY BOX

Master: 5 Inner: 1
UPC: 8-02090-18198-6

19 pc SAE / Metric 3/8" Dr. Socket Set

- 3/8" drive ratchet
- 9 Inch sizes: 3/8, 7/16, 15/32, 1/2, 9/16, 5/8, 11/16, 3/4 and 13/16"
- 9 Metric sizes: 9, 10, 11, 12, 13, 14, 15, 17 and 19mm
- Fully polished and chrome plated
- Bonus storage rack included



18181 - HANG TAB

Master: 24 Inner: 6
UPC: 8-02090-18181-8

40 pc Socket Set

- Carbon steel construction
- 12 1/4" Dr. SAE sockets & 13 1/4" Dr. Metric sockets
- 3 3/8" Dr. SAE sockets: 7/16-9/16"
- 3 3/8" Dr. Metric sockets: 11-13mm
- 3 1/4" Dr. (8pt) sockets: 1/4-3/8"
- 1 3/8" Dr. ratchet handle
- 1/4" Dr. spinner handle, 3/8" Dr. 3" extension bar, 1/4" x 3/8" drive adapter, 3/8" Dr. spin disc



18196 - DISPLAY BOX

Master: 16 Inner: 1
UPC: 8-02090-18196-1

17 pc SAE / Metric 1/2" Dr. Socket Set

- 1/2" drive ratchet
- 8 Inch sizes: 3/8, 7/16, 1/2, 9/16, 5/8, 11/16, 3/4 and 13/16"
- 8 Metric sizes: 10, 11, 12, 13, 14, 15, 17 and 19mm
- Fully polished and chrome plated
- Bonus storage rack included



18182 - HANG TAB

Master: 24 Inner: 6
UPC: 8-02090-18182-5

Socket Holders

1/4" DR. HOLDER 31096 - CARDED

Master: 96 Inner: 6
UPC: 8-02090-31096-6

3/8" DR. HOLDER 38096 - CARDED

Master: 48 Inner: 6
UPC: 8-02090-38096-9

1/2" DR. HOLDER 32096 - CARDED

Master: 48 Inner: 6
UPC: 8-02090-32096-5



45 pc 1/4" & 3/8" Dr. Stubby Set

- 1/4" & 3/8" Ratchet - Stubby Wrench - High Torque Ratcheting Screwdriver
- 27 pc Chrome plated carbon steel sockets, Sizes: SAE: 5/32, 3/16, 7/32, 1/4, 9/32, 5/16, 11/32, 3/8, 7/16, 1/2, 9/16, 5/8, 3/4". MM: 4, 4.5, 5 through 15, & 17
- Extension Bar - Screwdriver Adaptors
- 12 pc CR-V screwdriver Bits:
 - Phillips: (2) #1, (2) #0, & (1) #00, Slotted: 1/8 & 3/32", Pozi: #0 & #1
 - Hex: 1/8, 7/64, 3/32, & 1/16", Star: T5, T7, T8, T9, T10, T15, T20

18020 - HANG TAB

Master: 12 Inner: 6
UPC: 8-02090-18020-1



16 pc SAE / Metric Hex Key Set

- Nickel plated SAE keys
- Size includes: 1/16, 5/64, 3/32, 1/8, 5/32, 3/16, 7/32, 1/4"
- Black finish Metric keys
- Size Includes: 1.5, 2, 2.5, 3, 4, 5, 5.5, & 6mm
- Made of Carbon Steel
- Conveniently stored on key rings

12726 - POUCH

Master: 96 Inner: 12
UPC: 8-02090-12726-7



10 pc Hex Bit Socket Sets

- 3/8" drive - Chrome vanadium steel construction
- Bonus storage rail included

SAE Bit Set: 3/32, 7/64, 1/8, 9/64, 3/16, 7/32, 1/4, 5/16 and 3/8"

16133 - CARDED

Master: 24 Inner: 6
UPC: 8-02090-16133-6

Metric Bit Set: 2, 3, 4, 5, 5.5, 6, 7, 8, 9 and 10mm

16134 - CARDED

Master: 24 Inner: 6
UPC: 8-02090-16124-5



9 pc 3/8" Dr Star Socket Bit Set

- Sizes include: T10, T15, T20, T25, T27, T30, T40, T45, & T50
- 3/8" Drive
- Storage rail included

16129 - CARDED

Master: 48 Inner: 6
UPC: 8-02090-16129-2

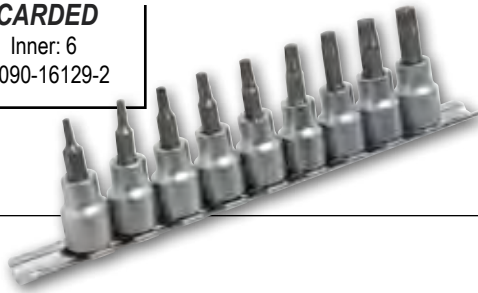

9 pc External Star Socket Set

- Contains 1 each of the following:
 - 1/4" Dr.: E5, E6, E7, E8
 - 3/8" Dr.: E10, E12, E14, E16
 - 1/4" (M) x 3/8" (F) Socket Adapter

16139 - CARDED

Master: 36 Inner: 6
UPC: 8-02090-16139-1



42 pc Screwdriver Set

- Chrome vanadium steel shafts
- Magnetic tips hold screws securely for confined areas
- Handle holes to hang for storage
- Mini magnetic parts tray
- Slotted, phillips, square drive and Star drivers, precision picks, tack puller and 9 SAE and 9 Metric 1/4" dr. sockets

17242 - CARDED

Master: 8 Inner: 1
UPC: 8-02090-17242-7



10 pc Screwdriver Set with Magnetic Dish and Pick-up Tool

- Chrome vanadium shafts with magnetic tips
- Handle holes to hang for storage
- 8 assorted slotted, phillips and square drive screwdrivers
- Mini magnetic parts dish
- Telescoping magnetic pick-up tool

17240 - CARDED

Master: 12 Inner: 6
UPC: 8-02090-17240-3



4 pc Precision Pick Set

- Comfortable TPR sure-grip handles
- Chrome plated shafts
- Includes 4 picks: Curved, 90 degree, Offset and Straight

17710 - CARDED

Master: 48 Inner: 12
UPC: 8-02090-17710-1



32976 - DISPLAY
(TITAN BRAND - YELLOW)

Master: 36 Inner: 6
UPC: 8-02090-32976-0

4 pc Precision Pliers Set

- Compact size for restricted areas and precision work
- Red vinyl-dipped handles for comfort and better grip
- Includes Diagonal Cutter, Flat Nose Pliers, Needle Nose Pliers and End Nippers

18406 - CARDED

Master: 300 Inner: 25
UPC: 8-02090-50013-8



4 pc Mini Screwdriver Set

- Contains:
- #1 & #2 Phillips, 3/16" & 1/4" Slotted
 - Perfect for use in hard to reach or confined areas

17204 - CARDED

Master: 96 Inner: 12
UPC: 8-02090-17204-5

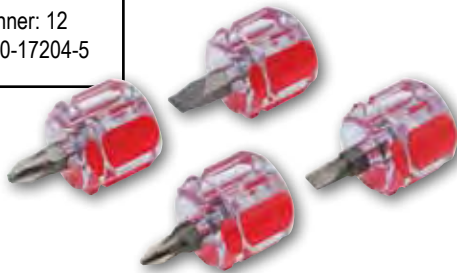

Multi-Funtion Tool

- Folding compact tool set includes most commonly used everyday household tools
- Perfect for home, auto, truck, rv, boat, motor-cycle, bicycle, and many other uses
- Stainless steel construction, Blue or Red anodized handle
- Ships in 8 pack counter display

12133 4 Red, 4 Blue - **COUNTER DISPLAY**

Master: 4 Inner: 1 UPC: 8-02090-12133-3

12135 Red Only - **COUNTER DISP.**

Master: 4 Inner: 1 UPC: 8-02090-12135-7

12136 Blue Only - **COUNTER DISP.**

Master: 4 Inner: 1 UPC: 8-02090-12136-4

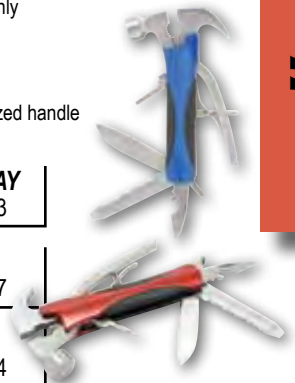

Ratcheting Driver Set

- Comfortable TPR triangular ratcheting handle - 1/4" Dr Adapter (25mm)
- Chrome vanadium bits
- Phillips: 0, 1, 2, & #3, Slotted: 1/8, 5/32, 3/16, & 1/4"
- Star: T15, T20, T25 & T30, Square: 0, 1, 2, 3
- 1/4" Dr Sockets, MM: 8, 9, 10, 11, & 12mm. SAE: 5/16, 11/32, 3/8, 7/16, & 15/32"
- Bit storage in handles - Includes convenient holster

16029 - CARDED

Master: 24 Inner: 6
UPC: 8-02090-16029-5



31 pc Bit & Driver Set

- Sizes Include:
- Slotted: 3.5, 4.5, 5.5, 6, 8
- Hex: 2, 2.5, 3, 4, 5, 6, 8
- Phillips: #0, #1, #2, #3
- Pozi: #0, #1, #2, #3
- Square: #1, #2
- Star: T9, 10, 15, 20, 25, 27, 30, 40
- Plastic bit case

16067 - HANG TAB

Master: 48 Inner: 12
UPC: 8-02090-16067-7



204 pc Master Drill and Bit Set

High Speed Steel Drill Bits:

51 - Titanium-Coated High Speed Steel Drill Bits, Brad Point Wood Bits, Standard & 1/2-inch Wood Boring Bits, Hex-Shank Pilot Bits, Standard and 1/2-inch Masonry Bits, Power Nut drivers, Power Screwdriver Bits, Nailsets, Center Punch, Drill Stoppers, Screw Finders, Counter Sink, Drill Gauge, Holesaws and more!

Unique Quad-panel tri-fold storage case opens to access the tools you need or folds compact for easy storage or transportation.

16204 - DISPLAY BOX

Master: 4 Inner: 1

UPC: 8-02090-16204-6

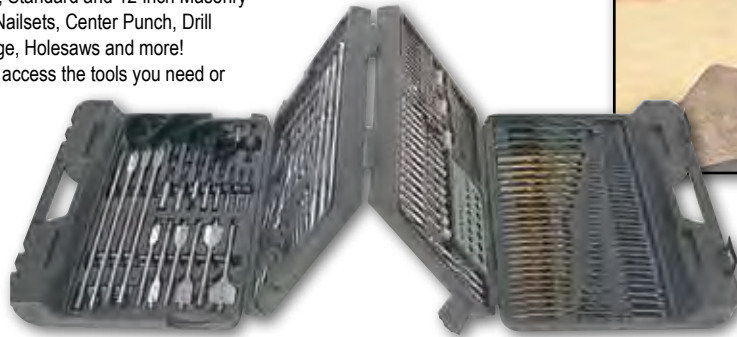

45 pc Multi-Use Power Bit Set

- 7 power nut drivers
- 27 various screwdriver bits
- 5 high-speed steel quick-disconnect drill bits
- 1/4" adaptor, magnetic bit extension, more

16044 - CARDED

Master: 12 Inner: 6

UPC: 8-02090-16044-8



125 pc Multi-Use Power Bit and Drill Bit Set

- 28 various drill bits
- 14 power nut drivers
- 67 power screwdriver bits
- Hole saws, countersink, center punch, screw finders, magnetic extension, bit holders

16125 - CARDED

Master: 5 Inner: 1

UPC: 8-02090-16125-4



100 pc Security Bit Set

- Assortment of the most popular, and hard to find bits for many different applications
- Contains Phillips, slotted, square drive, Star, Pozi-drive, inch and metric Hex, tamper resistant Star, tamper resistant hex, clutch drive, spline drive, spanner, three wing and four wing drives.

16100 - CARDED

Master: 20 Inner: 10

UPC: 8-02090-16100-1



Mini All-Purpose Cleaning Brush

- Compact size
- Non-marring finish
- Wrap-around handle
- Ships in 12 pack counter display

22603 - COUNTER DISPLAY

Master: 160 Inner: 20
UPC: 8-02090-22603-8



Pocket Tire Gauge

- 10-60 PSI
- Angled head
- Handy pocket clip
- Ships in 25 pack counter display

50013 - COUNTER DISPLAY

Master: 300 Inner: 25
UPC: 8-02090-50013-8

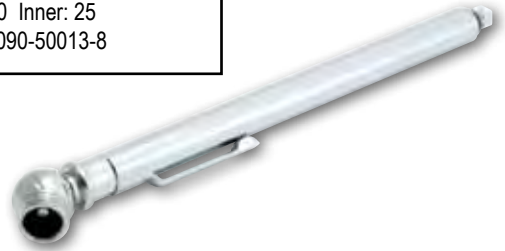

Telescoping Inspection Mirror

- Extends to 18-1/2"
- 1-1/8" Diameter inspection mirror
- Handy pocket clip
- Ships in 25 pack counter display

11160 - COUNTER DISPLAY

Master: 300 Inner: 25
UPC: 8-02090-11160-0



3 lb. Magnetic Retriever

- Extends to 25"
- Handy pocket clip
- Ships in counter display

11161 - COUNTER DISPLAY

Master: 300 Inner: 25
UPC: 8-02090-11161-7



1,000 pc Cotter Pin Assortment

- Contains:
 1/16" x 1" (380 PCS) 3/32" x 1" (240 PCS)
 3/32" x 1-1/2" (140 PCS) 1/8" x 1-1/4" (115 PCS)
 1/8" x 2" (75 PCS) 5/32" x 2-1/2" (50 PCS)

45204 - DISPLAY BOX

Master: 24 Inner: 6
 UPC: 8-02090-45204-8



555 pc Cotter Pin Assortment

- Contains:
 1/16" x 1" (150 PCS) 3/32" x 1" (150 PCS)
 3/32" x 1-1/2" (100 PCS) 1/8" x 1-1/4" (75 PCS)
 1/8" x 2" (50 PCS) 5/32" x 2-1/2" (30 PCS)

45205 - DISPLAY BOX

Master: 24 Inner: 6
 UPC: 8-02090-45205-5



144 pc Large Cotter Pin Assortment

- Contains:
 1/8" x 2" (50 PCS) 5/32" x 2-1/2" (30 PCS)
 3/16" x 3" (20 PCS) 1/4" x 2" (20 PCS)
 1/4" x 3" (16 PCS) 5/16" x 2-1/2" (8 PCS)

45206 - DISPLAY BOX

Master: 24 Inner: 6
 UPC: 8-02090-45206-2



555 pc Stainless Steel Cotter Pin Assortment

- Contains:
 1/16" x 1" (150 PCS) 3/32" x 1" (150 PCS)
 3/32" x 1-1/2" (100 PCS) 1/8" x 1-1/4" (75 PCS)
 1/8" x 2" (50 PCS) 5/32" x 2-1/2" (30 PCS)

45245 - DISPLAY BOX

Master: 24 Inner: 6
 UPC: 8-02090-45245-1

**STAINLESS
 STEEL!**



150 pc Hitch Pin Assortment

- Contains:
 3/32" x 1-3/16" (42 PCS) 5/64" x 1-5/16" (30 PCS)
 5/64" x 1-9/16" (25 PCS) 7/64" x 1-5/8" (25 PCS)
 9/64" x 1-3/4" (20 PCS) 5/32" x 2-15/16" (8 PCS)

45210 - DISPLAY BOX

Master: 24 Inner: 6
 UPC: 8-02090-45210-9



71 pc Clevis Pin Assortment

- Contains:
 Tiller Tine Pins
 5/16" x 2", 5 PCS 3/8" x 2", 18 PCS
 7/16" x 2-1/2", 5 PCS 1/2" x 2", 3 PCS
 Hair Pins:
 5/64" x 1-5/16", 7 PCS 7/64" x 1-5/8", 20 PCS
 7/64" x 2-5/16", 7 PCS 9/64" x 1-3/4", 6 PCS

45359 - DISPLAY BOX

Master: 24 Inner: 6
 UPC: 8-02090-45359-5



20 pc Clevis Pin Assortment

- Contains:
- | | | | |
|----------------|-------|----------------|-------|
| 1/4" x 1-1/4" | 1 PC | 1/4" x 1-1/2" | 2 PCS |
| 1/4" x 2" | 1 PC | 5/16" x 1" | 1 PC |
| 5/16" x 1-1/4" | 1 PC | 5/16" x 1-1/2" | 2 PCS |
| 5/16" x 2" | 2 PCS | 5/16" x 2-1/4" | 2 PCS |
| 5/16" x 2-1/2" | 2 PCS | | |
| 5/16" x 3" | 2 PCS | | |
| 3/8" x 1" | 1 PC | | |
| 3/8" x 2" | 2 PCS | | |
| 3/8" x 2-3/8" | 1 PCS | | |

45249 - DISPLAY BOX

Master: 24 Inner: 6
 UPC: 8-02090-45249-9



200 pc Hex Head Drill Screw Assortment

- Contains:
 #8 x 1/2", #8 x 5/8", #8 x 3/4", #8 x 1" (30 PCS ea. size)
 #10 x 1/2", #10 x 5/8", #10 x 3/4", #10 x 1" (20 PCS ea. size)

45220 - DISPLAY BOX

Master: 24 Inner: 6
 UPC: 8-02090-45220-8



General Tools

347 pc SAE Screw Assortment

- Contains:
- #6 x 1/2", #6 x 3/4", #10 x 1" Sheet Metal Screws (26 PCS/32 PCS/13 PCS)
- #4 x 1/2", #6 x 3/4", #8 x 1" Wood Screws (43 PCS/32 PCS/10 PCS)
- #10, 1/4" Flat Washers (59 PCS/19 PCS)
- #10 x 3/4", #10 x 1", 1/4" x 3/4"
- Machine Screws (10PCS/24PCS/19 PCS)
- #10-24, 1/4"-20 Hex Nuts (49PCS/11 PCS)
- Convenient re-sealable plastic case

45221 - DISPLAY BOX

Master: 24 Inner: 6
UPC: 8-02090-45221-5



347 pc Metric Screw Assortment

- Contains:
- #6 x 1/2", #6 x 3/4", #10 x 1" Sheet Metal Screws (32 PCS/26 PCS/13 PCS)
- #4 x 1/2", #6 x 3/4", #8 x 1" Wood Screws (43 PCS/32 PCS/10 PCS)
- M5m M6 Flat Washers (59 PCS/19 PCS)
- #6 x 3/4", #10 x 3/4", #10 x 1"
- Machine Screws (10 PCS/24 PCS/19 PCS)
- M5, M6 Hex Nuts (49 PCS/11 PCS)
- Convenient re-sealable plastic case

45222 - DISPLAY BOX

Master: 24 Inner: 6
UPC: 8-02090-45222-2



160 pc SAE Socket Head Set Screw Assortment

- Contains: USS & SAE Thread
- 1/4" x 1/4" - 20 20 PCS
- 1/4" x 3/8" - 20 10 PCS
- 5/16" x 3/8" - 18 20 PCS
- 5/16" x 1/2" - 18 10 PCS
- 3/8" x 3/8" - 16 10 PCS
- 3/8" x 1/2" - 18 10 PCS
- 1/8" x 3/16" - 40 15 PCS
- 3/16" x 1/4" - 24 10 PCS
- 5/32" x 3/16" - 32 15 PCS
- 1/4" x 1/4" - 28 15 PCS
- 5/16" x 3/8" - 24 15 PCS
- 3/8" x 3/8" - 24 10 PCS
- Convenient re-sealable plastic case

45235 - DISPLAY BOX

Master: 24 Inner: 6
UPC: 8-02090-45235-2



160 pc Metric Socket Head Set Screw Assortment

- Contains:
- 3mm x 5mm 15 PCS 4mm x 5mm 15 PCS
- 5mm x 6mm 10 PCS 6mm x 6mm 20 PCS
- 6mm x 6mmF 15 PCS 6mm x 10mm 10 PCS
- 8mm x 10mm 20 PCS 8mm x 10mmF 15 PCS
- 8mm x 12mm 10 PCS
- 10mm x 10mm 10 PCS
- 10mm x 10mmF 10 PCS
- 10mm x 12mm 10 PCS
- Convenient re-sealable plastic case

45251 - DISPLAY BOX

Master: 24 Inner: 6
UPC: 8-02090-45251-2



106 pc SAE Socket Head Screw Assortment

- Contains:
- #8 x 32 x 1/2", #10 x 24 x 1/2" (25 PCS ea. size), #10 x 24 x 1" (20 PCS)
- 1/4" x 20 x 1/2", 1/4" x 20 x 1" (10 PCS ea. size)
- 5/16" x 18 x 1", 5/16" x 18 x 1-1/2" (5 PCS ea. size)
- 3/8" x 16 x 1", 3/8" x 16 x 1-1/2" (3 PCS ea. size)
- Convenient re-sealable plastic case

45306 - DISPLAY BOX

Master: 24 Inner: 6
UPC: 8-02090-45306-9



106 pc Metric Socket Head Screw Assortment

- Contains:
- M4 x 12, M5 x 12 (25 PCS ea. size), M5 x 25 (20 PCS)
- M6 x 12, M6 x 25 (10 PCS ea. size)
- M8 x 25, M8 x 40 (5 PCS ea. size)
- M10 x 25, M10 x 40 (3 PCS ea. size)
- Convenient re-sealable plastic case

45307 - DISPLAY BOX

Master: 24 Inner: 6
UPC: 8-02090-45307-6



475 pc Metric Nut & Bolt Assortment

- Contains:
- M4x16, M4x25, M5x20, M5x25, M6x20 Machine Screws (20 PCS ea. size)
- #4, #5 Lock Washers (50 PCS ea. size), #6 Lock Washers (25 PCS)
- #4, #5 Flat Washers (50 PCS ea. size), #6 Flat Washers (25 PCS)
- M4, M5 Hex Nuts (50 PCS ea. size), M6 Hex Nuts (25 PCS)
- Convenient re-sealable plastic case

45250 - DISPLAY BOX

Master: 24 Inner: 6
UPC: 8-02090-45250-5



475 pc Stainless Steel Metric Nut & Bolt Assortment

- Contains:
- M4x16, M4x25, M5x20, M5x25, M6x20 Machine Screws (20 PCS ea. size)
- M4, M5 Lock Washers (50 PCS ea. size), M6 Lock Washers (25 PCS)
- M4, M5 Flat Washers (50 PCS ea. size), M6 Flat Washers (25 PCS)
- M4, M5 Hex Nuts (50 PCS ea. size), M6 Hex Nuts (25 PCS)
- Stainless Steel
- Convenient re-sealable plastic case

45248 - DISPLAY BOX

Master: 24 Inner: 6
UPC: 8-02090-45248-2



STAINLESS STEEL!

General Tools



240 pc Self-Tapping Wood & Metal Screw Assortment

- Contains:
- #4 x 1/2", #6 x 1/2", #6 x 5/8", #6 x 3/4", #8 x 5/8", and #8 x 1" Wood Screws (20 PCS ea. size) #6 x 1/2", #6 x 3/4", #8 x 1/2", #8 x 5/8", #8 x 3/4", and #10 x 1" Metal Screws (20 PCS ea. size)
- Convenient re-sealable plastic case

45234 - DISPLAY BOX

Master: 24 Inner: 6
UPC: 8-02090-45234-5



300 pc Metric Nut Assortment

- Contains:
- M3 x 0.5 (80 PCS) M4 x 0.7 (70 PCS)
- M5 x 0.8 (70 PCS) M6 x 1.0 (50 PCS)
- M8 x 1.25 (20 PCS) M10 x 1.50 (10 PCS)
- Convenient re-sealable plastic case

45300 - DISPLAY BOX

Master: 24 Inner: 6
UPC: 8-02090-45300-7



**STAINLESS
STEEL!**

150 pc Nylon Locknut Assortment

- Contains:
- #10 x 24 25 PCS
- 1/4" x 20 35 PCS
- 1/4" x 28 25 PCS
- 5/16" x 18 30 PCS
- 3/8" x 16 25 PCS
- 1/2" x 13 10 PCS
- Nylon inserts prevent loosening
- Convenient re-sealable plastic case

45223 - DISPLAY BOX

Master: 24 Inner: 6
UPC: 8-02090-45223-9



100 pc USS (UNC) Nylon Locknut Assortment

- Contains:
- #10 x 24 25 PCS
- 1/4" x 20 25 PCS
- 5/16" x 18 20 PCS
- 3/8" x 16 20 PCS
- 7/16" x 14 5 PCS
- 1/2" x 13 5 PCS
- Nylon inserts prevent loosening
- Convenient re-sealable plastic case

45233 - DISPLAY BOX

Master: 24 Inner: 6
UPC: 8-02090-45233-8



100 pc Metric Nylon Locknut Assortment

- Contains:
- M4 25 PCS
- M5 25 PCS
- M6 20 PCS
- M8 15 PCS
- M10 10 PCS
- M12 5 PCS
- Nylon inserts prevent loosening
- Convenient re-sealable plastic case

45243 - DISPLAY BOX

Master: 24 Inner: 6
UPC: 8-02090-45243-7



100 pc SAE (UNF) Nylon Locknut Assortment

- Contains:
- #10 x 32 25 PCS
- 1/4" x 28 25 PCS
- 5/16" x 24 20 PCS
- 3/8" x 24 20 PCS
- 7/16" x 20 5 PCS
- 1/2" x 20 5 PCS
- Nylon inserts prevent loosening
- Convenient re-sealable plastic case

45242 - DISPLAY BOX

Master: 24 Inner: 6
UPC: 8-02090-45242-0



550 pc Nail Assortment

- Contains:
- 3/64" x 7/8" Brad Nails 100 PCS
- 3/64" x 1" Brad Nails 80 PCS
- 1/16" x 1-1/4" Brad Nails 80 PCS
- 1/16" x 1-1/2" Brad Nails 50 PCS
- 3/32" x 1-1/4" Brad Nails 30 PCS
- 3/32" x 2" Brad Nails 20 PCS
- 3/64" x 1" Finishing Nails 80 PCS
- 3/64" x 1-1/4" Finishing Nails 80 PCS
- 3/32" x 1-1/2" Masonry Nails 30 PCS
- Convenient re-sealable plastic case

45240 - DISPLAY BOX

Master: 24 Inner: 6
UPC: 8-02090-45240-6



151 pc Hook & Eye Screw Assortment

- Contains:
- Eye Screws
- 1-1/8" 60 pcs
- 1-13/16" 12 pcs
- 1-15/16" 12 pcs
- Hook Screws
- 1-5/8" 50 pcs
- 2-1/2" 12 pcs
- 3-3/8" 5 pcs
- Convenient re-sealable plastic case

45340 - DISPLAY BOX

Master: 24 Inner: 6
UPC: 8-02090-45340-3



240 pc USS Nut & Bolt Assortment

- Contains:
- Bolts: #8 x 1/2", #8 x 3/4", #10 x 5/8", #10 x 1", 1/4" x 3/4", 1/4" x 1-1/4" (10 PCS ea. size), 5/16" x 1", 5/16" x 1-1/2", 3/8" x 5/8", 3/8" x 1-1/2" (5 PCS ea. size)
- Hex Nuts: #8, #10, 1/4" (20 PCS ea. size), 5/16", 3/8" (10 PCS ea. size)
- Washers: #8, #10, 1/4" (20 PCS ea. size), 5/16", 3/8" (10 PCS ea. size)
- Black Oxide Finish
- Convenient re-sealable plastic case

45330 - DISPLAY BOX

Master: 24 Inner: 6
UPC: 8-02090-45330-4



240 pc Metric Nut & Bolt Assortment

- Contains:
- Bolts: M4 x 12M, M4 x 20M, M5 x 16M, M5 x 25M, M6 x 20M, M6 x 30M (10 PCS ea. size), M8 x 25M, M8 x 40M, M10 x 16M, M10 x 40M (5 PCS ea. size)
- Hex Nuts: M4, M5, M6 (20 PCS ea. size), M8, M10 (10 PCS ea. size)
- Washers: M4, M5, M6 (20 PCS ea. size), M8, M10 (10 PCS ea. size)
- Black Oxide Finish
- Convenient re-sealable plastic case

45331 - DISPLAY BOX

Master: 24 Inner: 6
UPC: 8-02090-45331-1



240 pc USS Nut & Bolt Assortment

- Contains:
- Bolts: #8 x 1/2", #8 x 3/4", #10 x 5/8", #10 x 1", 1/4" x 3/4", 1/4" x 1-1/4" (10 PCS ea. size), 5/16" x 1", 5/16" x 1-1/2", 3/8" x 5/8", 3/8" x 1-1/2" (5 PCS ea. size)
- Hex Nuts: #8, #10, 1/4" (20 PCS ea. size), 5/16", 3/8" (10 PCS ea. size)
- Washers: #8, #10, 1/4" (20 PCS ea. size), 5/16", 3/8" (10 PCS ea. size)
- Zinc Oxide Finish
- Convenient re-sealable plastic case

45333 - DISPLAY BOX

Master: 24 Inner: 6
UPC: 8-02090-45333-5



240 pc Metric Nut & Bolt Assortment

- Contains:
- Bolts: M4 x 12M, M4 x 20M, M5 x 16M, M5 x 25M, M6 x 20M, M6 x 30M (10 PCS ea. size), M8 x 25M, M8 x 40M, M10 x 16M, M10 x 40M (5 PCS ea. size)
- Hex Nuts: M4, M5, M6 (20 PCS ea. size), M8, M10 (10 PCS ea. size)
- Washers: M4, M5, M6 (20 PCS ea. size), M8, M10 (10 PCS ea. size)
- Zinc Oxide Finish
- Convenient re-sealable plastic case

45334 - DISPLAY BOX

Master: 24 Inner: 6
UPC: 8-02090-45334-2



General Tools

720 pc Lock, Spring, & Star Washer Assortment

- Contains:
- #6, #8, #10 (50 PCS ea. size)
- 1/4", 5/16", 3/8" (40 PCS/30 PCS/20 PCS)
- Convenient re-sealable plastic case

45218 - DISPLAY BOX

Master: 24 Inner: 6
UPC: 8-02090-45218-5



350 pc Flat & Lock Washer Assortment

- Contains:
- #6, #8, #10 Flat Washers (50 PCS/40 PCS/30 PCS)
- 1/4", 5/16", 3/8" Flat Washer (25 PCS/15 PCS/15 PCS)
- #6, #8, #10 Lock Washers (50 PCS/40 PCS/30 PCS)
- 1/4", 5/16", 3/8" Lock Washer (25 PCS/15 PCS/15 PCS)
- Convenient re-sealable plastic case

45216 - DISPLAY BOX

Master: 24 Inner: 6
UPC: 8-02090-45216-1



110 pc Copper Washer Assortment

- Contains:
- 1/4" Washer 30 PCS
- 5/16" Washer 25 PCS
- 3/8" Washer 20 PCS
- 7/16" Washer 15 PCS
- 1/2" Washer 10 PCS
- 5/8" Washer 10 PCS
- Convenient re-sealable plastic case

45217 - DISPLAY BOX

Master: 24 Inner: 6
UPC: 8-02090-45217-8



300 pc E-Clip Assortment

- Contains:
- 1/16" 30 PCS
- 3/16" 40 PCS
- 3/8" 50 PCS
- 5/8" 20 PCS
- 7/8" 20 PCS
- 1/8" 30 PCS
- 1/4" 50 PCS
- 1/2" 40 PCS
- 3/4" 20 PCS
- Black Oxide Finish
- Convenient re-sealable plastic case

45208 - DISPLAY BOX

Master: 24 Inner: 6
UPC: 8-02090-45208-6



300 pc Snap Ring Assortment

- Contains:
- INTERNAL
- 3/16" (15 PCS), 3/8" (20 PCS), 7/16", 15/32" (15 PCS ea. size)
- 3/4" (25 PCS), 7/8" (20 PCS)
- EXTERNAL
- 1/8" (20 PCS), 5/32" (10 PCS), 1/4" (25 PCS),
- 5/16" (15 PCS), 1/2" (25 PCS), 9/16" (15 PCS),
- 5/8" (20 PCS), 13/16", 1", 1-1/16" (15 PCS ea. size)
- 1-1/8" (10 PCS), 1-1/4" (5 PCS)
- Convenient re-sealable plastic case

45212 - DISPLAY BOX

Master: 24 Inner: 6
UPC: 8-02090-45212-3



120 pc Roll Pin Assortment

- Contains:
- 5/32" x 5/8", 5/32" x 1", 5/32" x 1-1/2", 1/4" x 5/8", 1/4" x 1-1/4", 1/4" x 1-3/4",
- 5/16" x 3/4", 5/16" x 1-1/2", 5/16" x 2", 5/64" x 1/4", 5/64" x 1/2", 5/64" x 1", 1/16"
- x 3/16", 1/16" x 3/4", 1/16" x 5/16", 3/32" x 5/8", 3/32" x 1-1/4", 3/32" x 1-3/4" (4
- PCS ea. size), 1/8" x 5/8", 1/8" x 1", 1/8" x 1-1/4" (5 PCS ea. size), 3/8" x 3/4",
- 3/8" x 1-1/2", 3/8" x 2" (2 PCS ea. size), 7/32" x 5/8", 7/32" x 1-1/4", 7/32" x
- 1-3/4" (4 PCS ea. size), 3/16" x 5/8", 3/16" x 1", 3/16" x 1-1/4" (5 PCS ea. size)
- Convenient re-sealable plastic case

45342 - DISPLAY BOX

Master: 24 Inner: 6
UPC: 8-02090-45342-7



General Tools

60 pc Machinery Key Assortment

- Contains:
- 1/8" x 1/8" x 3/4", 1/8" x 1/8" x 1" (4 PCS ea. size)
- 3/16" x 3/16" x 3/4", 3/16" x 3/16" x 1", 3/16" x 3/16" x 1-1/4", 1/4" x 1/4" x
- 3/4", 1/4" x 1/4" x 1-1/4", 1/4" x 1/4" x 1-1/2", 5/16" x 5/16" x 1-1/4", 5/16"
- x 5/16" x 1-1/2", 3/8" x 3/8" x 1-1/4", 3/8" x 3/8" x 1-1/2" (5 PCS ea. size)
- 1/2" x 1/2" x 1-1/2" (2 PCS)
- Convenient re-sealable plastic case

45341 - DISPLAY BOX

Master: 24 Inner: 6
UPC: 8-02090-45341-0

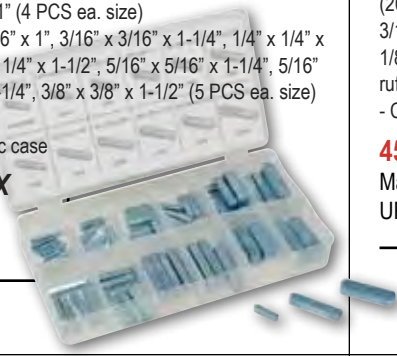

295 pc Shop Assortment

- Contains:
- 3/8", 1/2", 5/8", 3/4" Retaining Ring (12 PCS ea. size), 1/4", 3/8" E-Clip
- (20 PCS ea. size), 1/8 x 5/8", 1/8 x 1", 5/32 x 5/8", 5/32 x 1", 3/16 x 5/8",
- 3/16 x 1" Roll Pin (12 PCS ea. size), 3/32 x 3/8", 3/32 x 1/2", 1/8 x 1/2",
- 1/8 x 5/8", 5/32 x 5/8" Woodruff Key (25 PCS ea. size), 3/16 x 3/4" Wood-
- ruff Key (10 PCS)
- Convenient re-sealable plastic case

45343 - DISPLAY BOX

Master: 24 Inner: 6
UPC: 8-02090-45343-4



34 pc Hose Clamp Assortment

- Contains:
- 5/8" (16mm) 8 PCS
- 3/4" (19mm) 8 PCS
- 7/8" (22mm) 6 PCS
- 1" (25mm) 4 PCS
- 1-1/16" (28mm) 4 PCS
- 1-1/4" (32mm) 4 PCS
- Convenient re-sealable plastic case

45348 - DISPLAY BOX

Master: 24 Inner: 6
UPC: 8-02090-45348-9



500 pc Aluminum Rivet Assortment

- Contains:
- 1/8" x 1/4" 120 PCS
- 1/8" x 5/16" 120 PCS
- 1/8" x 3/8" 120 PCS
- 3/16" x 5/16" 70 PCS
- 3/16" x 3/8" 70 PCS
- Rustproof Aluminum Rivet Body
- Steel Mandrel
- Convenient re-sealable plastic case

45228 - DISPLAY BOX

Master: 24 Inner: 6
UPC: 8-02090-45228-4



200 pc Spring Assortment

- Contains:
- Compression Springs - 7/32" x 11/16", 7/32" x 1-1/2", 9/32" x 1/2", 9/32" x 3/4", 1/4" x 13/32" (10 PCS ea. size), 23/64" x 1-3/8" (8 PCS), 3/8" x 5/8" (6 PCS), 3/8" x 3/4" (12 PCS) Extension Springs - 3/16" x 1-3/4" (8 PCS), 5/32" x 3-1/8" (12 PCS), 13/64" x 13/16", 7/32" x 1", 9/32" x 1-1/2" (10 PCS ea. size), 9/32" x 2-13/16", 11/32" x 1-27/32" (12 PCS ea. size), 11/32" x 1-7/16", 1/4" x 7/8" (10 PCS ea. size), 5/16" x 1-1/8" (8 PCS), 5/16" x 1-1/4" (10 PCS), 5/16" x 1-3/4" (12 PCS)
- Small compression and extension springs
- Re-sealable plastic case

45200 - DISPLAY BOX

Master: 24 Inner: 6
UPC: 8-02090-45200-0



225 pc SAE O-Ring Assortment

- Contains:
- 3/32" X 15/64" (10 PCS), 1/8" X 1/4", 5/32" X 9/32", 3/16" X 5/16" (20 PCS ea. size), 7/32" X 11/32", 1/4" X 3/8", 5/16" X 7/16" (15 PCS ea. size) 3/8" X 1/2", 3/8" X 9/16", 7/16" X 5/8", 1/2" X 11/16", 9/16" X 3/4", 5/8" X 3/4", 5/8" X 13/16", 11/16" X 7/8", 3/4" X 15/16", 3/4" X 1", 13/16" X 1-1/16" (10 PCS ea. size)
- Convenient re-sealable plastic case

45225 - DISPLAY BOX

Master: 24 Inner: 6
UPC: 8-02090-45225-3



270 pc HNBR O-Ring Assortment

- For R134A Air Conditioning systems
- Contains the following 18 most popular sizes
- 7/32" x 1/16", 1/4" x 1/16", 9/32" x 5/64", 5/16" x 1/16", 5/16" x 5/64", 5/16" x 5/64", 11/32" x 5/64" (20 PCS ea. size), 3/8" x 5/64" (10 PCS), 7/16" x 1/16", 7/16" x 5/64", 7/16" x 3/32", 1/2" x 5/64" (15 PCS ea. size) 9/16" x 1/16", 9/16" x 3/32", 5/8" x 5/64", 11/16" x 1/16", 11/16" x 1/8", 11/16" x 5/64" (10 PCS ea. size)
- Convenient re-sealable plastic case

45201 - DISPLAY BOX

Master: 24 Inner: 6
UPC: 8-02090-45201-7



WHAT IS HNBR?

Hydrogenated Nitrile Butadiene Rubber (HNBR), also known as Highly Saturated Nitrile (HSN), is special class of nitrile that has been hydrogenated to increase saturation of the butadiene part of the carbon polymer for greater chemical resistance, more thermal stability and greater tensile strength.

HNBR can meet application temperatures that are between -50°C and 165°C.

HNBR nitrile o-rings have excellent resistance to petroleum oils and sour gas.

407 pc SAE O-Ring Assortment

- Contains the 32 most popular sizes of SAE o-rings
- Constructed of Buna-N BG715 (Nitrile 70 Shore) Rubber
- Meets ASTM D-2000 SAE J200 Standards
- Convenient re-sealable plastic case

45202 - DISPLAY BOX

Master: 24 Inner: 6
UPC: 8-02090-45202-4



419 pc Metric O-Ring Assortment

- Contains the 32 most popular sizes of metric o-rings
- Constructed of Buna-N BG715 (Nitrile 70 Shore) Rubber
- Meets ASTM D-2000 SAE J200 Standards
- Convenient re-sealable plastic case

45203 - DISPLAY BOX

Master: 24 Inner: 6
UPC: 8-02090-45203-1



125 pc Rubber Grommet Assortment

- Contains:
- Rubber Grommets - 1/8" x 1/4" (15 PCS), 7/32" x 5/16" (10 PCS), 9/32" x 1/2" (7 PCS), 5/16" x 9/16" (3 PCS), 3/8" x 15/32" (6 PCS), 3/8" x 1/2" (5 PCS), 3/8" x 13/16" (3 PCS), 7/16" x 3/4" (4 PCS), 1/2" x 19/32" (3 PCS), 5/8" x 31/32" (3 PCS), 3/4" x 15/16" (2 PCS)
- Rubber Plugs - 9/32" (20 PCS), 3/8" (20 PCS), 1/2" (10 PCS), 5/8" (5 PCS), 3/4" (4 PCS), 7/8" (3 PCS), 1" (2 PCS)
- Convenient re-sealable plastic case

45214 - DISPLAY BOX

Master: 24 Inner: 6
UPC: 8-02090-45214-7



110 pc Rubber Grommet Assortment

- Contains:
- 1/4" (25 PCS), 5/16", 3/8", 7/16" (20 PCS ea. size) 1/2" (10 PCS), 5/8" (5 PCS), 7/8" (5 PCS), 1" (5 PCS)
- Convenient re-sealable plastic case

45236 - DISPLAY BOX

Master: 24 Inner: 6
UPC: 8-02090-45236-9



70 pc Grease Fitting Assortment

- Contains:
- 1/8" - 27 Straight 10 PCS
- 1/8" - 27 45° 5 PCS
- 1/8" - 27 90° 5 PCS
- 1/4" - 28 Straight 20 PCS
- 1/4" - 28 45° 5 PCS
- 1/4" - 28 90° 5 PCS
- 6mm x 1.0 Straight 10 PCS
- 8mm x 1.0 Straight 5 PCS
- 10mm x 1.0 Straight 5 PCS
- Convenient re-sealable plastic case

45215 - DISPLAY BOX

Master: 24 Inner: 6
UPC: 8-02090-45215-4



80 pc Vacuum Cap Assortment

- Contains:
- 3/16" 20 pcs
- 5/32" 20 pcs
- 7/32" 20 pcs
- 1/4" 10 pcs
- 5/16" 5 pcs
- 3/8" 5 pcs
- Constructed of heat resistant Buna-N Rubber
- Convenient re-sealable plastic case

45252 - DISPLAY BOX

Master: 24 Inner: 6
UPC: 8-02090-45252-9



158 pc Wire Nut Assortment

- Contains:
- Gray: #22 to #16 AWG Wire (300v) 40 PCS
- Blue: #22 to #14 AWG Wire (300v) 40 PCS
- Orange: #22 to #14 AWG Wire (600v) 50 PCS
- Yellow: #18 to #12 AWG Wire (600v) 18 PCS
- Red: #18 to #10 AWG Wire (600v) 10 PCS
- UL Listed and CSA Certified
- Flame-Retardant Polypropylene Shell
- Reuseable
- Convenient re-sealable plastic case

45339 - DISPLAY BOX

Master: 24 Inner: 6
UPC: 8-02090-45339-7



250 pc Welding Stud Assortment

- Contains:
- 2" x 3/40" 250 PCS
- For use with a stud welder or stud gun
- Copper coated steel construction
- Convenient re-sealable plastic case

45241 - DISPLAY BOX

Master: 24 Inner: 6
UPC: 8-02090-45241-3



96 pc ATO Blade Fuse Assortment

- Contains:
- 3A (Violet) 12 PCS 5A (Orange) 12 PCS
- 7.5A (Brown) 12 PCS 10A (Red) 12 PCS
- 15A (Blue) 12 PCS 20A (Yellow) 12 PCS
- 25A (Clear) 12 PCS 30A (Green) 12 PCS
- Zinc electrodes
- Convenient re-sealable plastic case

45227 - DISPLAY BOX

Master: 24 Inner: 6
UPC: 8-02090-45227-7



96 pc Mini Blade Fuse Assortment

- Contains:
- 3A (Violet) 12 PCS 5A (Orange) 12 PCS
- 7.5A (Brown) 12 PCS 10A (Red) 12 PCS
- 15A (Blue) 12 PCS 20A (Yellow) 12 PCS
- 25A (Clear) 12 PCS 30A (Green) 12 PCS
- Zinc electrodes
- Convenient re-sealable plastic case

45229 - DISPLAY BOX

Master: 24 Inner: 6
UPC: 8-02090-45229-1



24 pc Maxi Blade Fuse Assortment

- Contains:
- 20A (Yellow), 30A (Green), 40A (Orange), 50A (Red), 60A (Blue), 70A (Tan), 80A (Clear), 100A (Purple) 3 PCS ea. size
- Zinc electrodes
- Convenient re-sealable plastic case

45232 - DISPLAY BOX

Master: 24 Inner: 6
UPC: 8-02090-45232-1



88 pc Master Auto Fuse Assortment

- Contains:
- Maxi Blade Fuses - 20A (Yellow), 30A (Green), 40A (Orange), 50A (Red), 60A (Blue), 70A (Tan), 80A (Clear), 100A (Purple)
- Blade Fuses - 3A (Violet), 5A (Orange), 7.5A (Brown), 10A (Red), 15A (Blue), 20A (Yellow), 25A (Clear), 30A (Green)
- Mini Blade Fuses - 3A (Violet), 5A (Orange), 7.5A (Brown), 10A (Red), 15A (Blue), 20A (Yellow), 25A (Clear), 30A (Green) 5 PCS ea. size
- Zinc electrodes
- Convenient re-sealable plastic case

45230 - DISPLAY BOX

Master: 24 Inner: 6
UPC: 8-02090-45230-7



Solar Powered Auto Darkening Welding Helmet (Red)

- Protects against UV and infrared radiation in variable shades from DIN 9 to DIN 13
- Lens automatically darkens when arc is struck, returns to normal when welding stops
- Powered by solar cells w/ battery back-up

41260 - DISPLAY BOX

Master: 4 Inner: 1
UPC: 8-02090-41260-8

REPLACEMENT HEADGEAR

41263 - BULK

Master: 36 Inner: 1
UPC: 8-02090-41263-9

Switching Time: .000033 Seconds Light to Dark



Clear Protective Replacement Lenses

- Clear cover safety welding lenses
- Works with Vaper 41260
- Protect shaded lens from spatter and debris
- Includes: 1 inner lens and 1 outer lens

41261 - POLY BAG

Master: 100 Inner: 25
UPC: 8-02090-41261-5



Auto Darkening Welding Helmet

- Durable lightweight material is corrosion resistant and flame retardant
- Clear vision both prior to and during welding for safety and higher work efficiency and quality
- Protects against ultraviolet (UV) and infrared (IR) radiation
- Automatic shut-off saves batteries
- Complies with DIN, ISO EN379 and ANSI Z87.1 standard
- 3.5 x 1.5" viewing area

41254 - DISPLAY BOX

Master: 4 Inner: 1
UPC: 8-02090-41254-7

Switching Time: .000033 Seconds Light to Dark



Fixed Shade Welding Helmet

- Durable, lightweight material is flame retardant
- 3.5 x 2.75" viewable area
- Protects against ultraviolet (UV) and infrared (IR) radiation
- Complies with DIN, ISO EN379 and ANSI Z87.1 standard

41247 - DISPLAY BOX

Master: 4 Inner: 1
UPC: 8-02090-41247-9



Solar Powered Auto Darkening Welding Helmet (Black)

- Protects against UV and infrared radiation in variable shades from DIN 9 to DIN 13
- Lens automatically darkens when an arc is struck and returns to normal when welding stops
- Powered by solar cells with battery back-up

41262 - DISPLAY BOX

Master: 4 Inner: 1
UPC: 8-02090-41262-2

REPLACEMENT LENSES

41264 - POLY BAG

Master: 100 Inner: 25
UPC: 8-02090-41264-6

Switching Time: .000033 Seconds Light to Dark



Solar Powered Auto Darkening Welding Helmet (Eagle / Flag)

- Protects against UV and infrared radiation in variable shades from DIN 9 to DIN 13
- Lens automatically darkens when an arc is struck and returns to normal when welding stops
- Powered by solar cells with battery back-up

41265 - DISPLAY BOX

Master: 4 Inner: 1
UPC: 8-02090-41265-3

REPLACEMENT LENSES

41264 - POLY BAG

Master: 100 Inner: 25
UPC: 8-02090-41264-6

Switching Time: .000033 Seconds Light to Dark



Solar Powered Auto Darkening Welding Helmet (Flames)

- Protects against UV and infrared radiation in variable shades from DIN 9 to DIN 13
- Lens automatically darkens when an arc is struck and returns to normal when welding stops
- Powered by solar cells with battery back-up

41266 - DISPLAY BOX

Master: 4 Inner: 1
UPC: 8-02090-41266-0

REPLACEMENT LENSES

41264 - POLY BAG

Master: 100 Inner: 25
UPC: 8-02090-41264-6

Switching Time: .000033 Seconds Light to Dark



170 pc Titanium Coated Drill Bit Set

- Titanium coated bits last up to six times longer than a normal bit
- Made of high speed steel for durability
- Includes convenient metal storage case
- 19 different drill bit sizes:
- (5 ea) 21/64, 23/64, 3/8, & 1/2
- (10 ea) 3/64, 1/16, 5/64, 3/32, 1/8, 9/64, 5/32, 11/64, 3/16, 7/32, 15/64, 1/4, 9/32, 19/64, & 5/16"

11170 - BOXED

Master: 5 Inner: 1

UPC: 8-02090-11170-9



Solar Powered Auto Dark Welding Helmet

- Ultra high performance filters protect against UV & IR
- Automatically changes from a light to a dark state when arc is struck
- Variable shades from DIN 9 to DIN 13
- Durable, lightweight material is corrosion resistant and flame retardant
- Outside sensitivity adjustment provides clear vision prior to and during welding
- Turnover headband mechanism allows for greater comfort and reduces fatigue
- Utilizes high performance solar cells w/ 2 built-in 3V lithium batteries as power back-up
- Complies with DIN, ISO, EN379 and ANSI Z87.1-2003

41267 - BOXED

Master: 4 Inner: 1

UPC: 8-02090-41267-7



NEW PRODUCTS

4 pc Nylon Scraper Set

- Removes decals, emblems & body moulding without scratching surface
- Durable design absorbs hammer blows
- Edges can be re-sharpened
- Sizes Includes 3/4, 7/8, 1/2, 1-1/2"

11565 - CARDED

Master: 12 Inner: 6

UPC: 8-02090-11565-3



110 pc Grease Fit Assortment

- Straight includes:
- 30pc M6x1
- 20pc M8x1
- 20pc M10x1
- 90° includes
- 20pc M6x1
- 10pc M8x1
- 10pc M10x1
- Convenient re-sealable plastic case

45274 - LABEL

Master: 24 Inner: 6

UPC: 8-02090-45274-1



4 pc Tape Measure Set

- Contains (4) tape measures
- 12'x 5/8", 16'x 3/4", 25'x 1, 33'x 1

17504 - CARDED

Master: 12 Inner: 6

UPC: 8-02090-17504-6



Paddle Mixer

- Ideal for mixing paint
- Attaches to drill
- Overall length: 16-1/2 in

12032 - CARDED

Master: 48 Inner: 1

UPC: 8-02090-12032-9





BOZEMAN PRODUCTS

This Section Includes:

HAND TOOLS / CUTTING TOOLS

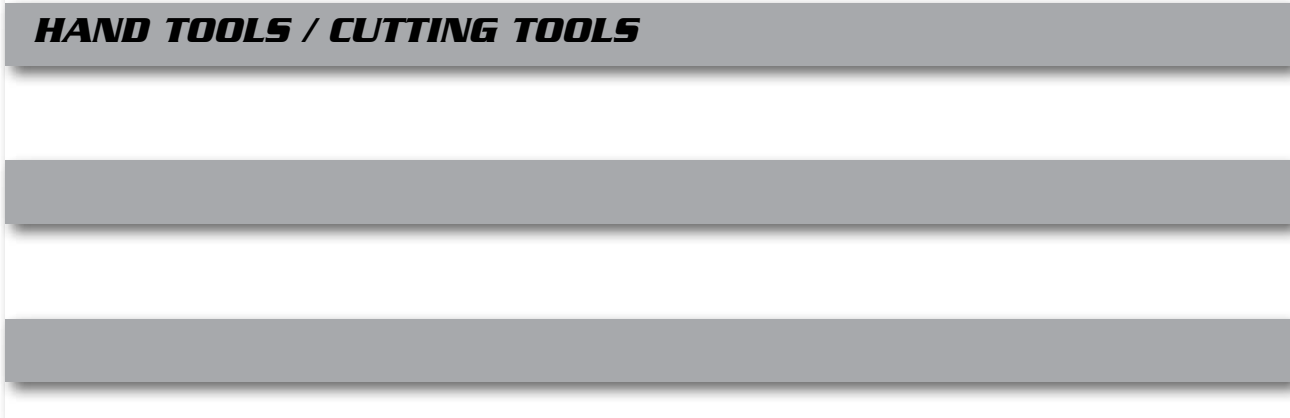

Multi-purpose Folding Pocket Knife

- Black satin finish blade - Open assist thumb tab on blade
- Overall length: 7.5", closed 4.5"
- Black stainless steel and aluminum handle - Handy belt clip
- Blade locks in open and closed positions

12112 - COUNTER DISPLAY

Master: 72 Inner: 12
UPC: 8-02090-12112-8



Multi-purpose Folding Pocket Knife

- Satin finish blade - Open assist thumb tab on blade
- Overall length: 8", closed 4.5"
- Black stainless steel handle - Handy belt clip
- Blade locks in open and closed positions

12111 - COUNTER DISPLAY

Master: 72 Inner: 12
UPC: 8-02090-12111-1



Hand Tools

Multi-purpose Folding Pocket Knife

- Matte finish blade - Open assist thumb tab on blade
- Overall length: 7.7", closed 4.5"
- Black satin stainless steel and aluminum handle with wood trim
- Blade locks in open & closed positions for safety
- Handy belt clip

12114 - COUNTER DISPLAY

Master: 72 Inner: 12
UPC: 8-02090-12114-2



Multi-purpose Folding Pocket Knife

- Matte finish blade
- Hunting knife style blade with bone saw, bottle opener and curved edge for skinning
- Open assist thumb tab on blade - Overall length: 7.5", closed 4"
- Black stainless steel and aluminum handle with gray resin trim
- Blade locks in open and closed positions for safety - Handy belt clip

12113 - COUNTER DISPLAY

Master: 72 Inner: 12
UPC: 8-02090-12113-5



Multi-purpose Folding Pocket Knife

- Satin finish blade - Open assist thumb tab on blade
- Overall length: 6", closed 4" - Anodized blue handle
- Blade locks in open position for safety - Handy belt clip

12120 - COUNTER DISPLAY

Master: 72 Inner: 12
UPC: 8-02090-12120-3



Multi-purpose Folding Pocket Knife

- Matte finish blade - Open assist thumb tab on blade
- Overall length: 8", closed 4.5"
- Black stainless steel and aluminum handle with wood trim
- Blade locks in open & closed positions - Handy belt clip

12115 - COUNTER DISPLAY

Master: 72 Inner: 12
UPC: 8-02090-12115-9



Multi-purpose Folding Pocket Knife

- Black satin finish handle with anodized blue trim
- Serrated blade
- Open assist thumb tab on blade
- Blade locks in open position for safety
- Handy belt clip
- Overall length: 6", closed 3.5"

12119 - COUNTER DISPLAY

Master: 96 Inner: 12
UPC: 8-02090-12119-7

12139 - CARDED

Master: 96 Inner: 6
UPC: 8-02090-12139-5



12 pc Multi-purpose Folding Pocket Knife Display

- Open assist thumb tab on blade for easy opening
- Blade locks in open and closed positions for safety
- Handy belt clip
- Package in tube in 12 pc counter display

12121 - COUNTER DISPLAY

Master: 6 Inner: 1
UPC: 8-02090-12121-0

12122 - COUNTER DISPLAY

Master: 6 Inner: 1
UPC: 8-02090-12122-7



12121



12122

Multi-purpose Folding Pocket Utility Knife

- Polished, stainless steel holder
- Aluminum handle
- Handy belt clip
- Blade locks in open position for safety
- Overall length: 6", closed 3.7"
- Open assist thumb tab on blade
- Accepts standard utility knife blades
- Includes 3 extra blades

12117 - CARDED

Master: 60 Inner: 12
UPC: 8-02090-12117-3



Multi-purpose Folding Pocket Utility Knife

- Polished, stainless steel holder
- Wood colored handle
- Handy belt clip
- Blade locks in open position for safety
- Overall length: 6", closed 3.7"
- Open assist thumb tab on blade
- Accepts standard utility knife blades
- Includes 3 extra blades

12116 - CARDED

Master: 60 Inner: 12
UPC: 8-02090-12116-6



All Purpose Shears

- Stainless steel precision ground blades for long-lasting edge
- Ergonomic handles for comfort
- Left or right hand usage
- Includes cutter, nut cracker, utility tool, scaler, bottle opener and can opener

12344 - CARDED

Master: 72 Inner: 12
UPC: 8-02090-12344-3



SCREWDRIVERS

- Magnetic tip - Chrome vanadium shaft
- Easy read tip indicator - Ergonomic handle



#2 X 4" Phillips	11230	UPC: 8-02090-11230-0
#1 X 3" Phillips	11231	UPC: 8-02090-11231-7
1/4" X 4" Slotted	11232	UPC: 8-02090-11232-4
3/16" X 3" Slotted	11233	UPC: 8-02090-11233-1
T-15 X 4" Star	11234	UPC: 8-02090-11234-8
R2 X 4" Square	11235	UPC: 8-02090-11235-5
BULK	Master: 100 Inner: 25	

5 pc Bit Sockets

- SAE size includes: 1/8, 5/32, 3/16, 7/32 and 1/4"
- Metric size includes: 3,4,5,6 and 7mm



32954 SAE

Master: 48 Inner: 6 UPC: 8-02090-32954-8

32955 Metric

Master: 48 Inner: 6 UPC: 8-02090-32955-5

5 pc Socket Sets

- SAE size includes: 11/32, 3/8, 7/16, 1/2 and 9/16"
- Metric Size includes: 9, 10, 12, 13 and 14mm
- Rubber boot for storage



32952 SAE

Master: 48 Inner: 6
UPC: 8-02090-32952-4

32953 Metric

Master: 48 Inner: 6
UPC: 8-02090-32953-1

25' Tape Measure

- 25' x 1" blade
- Easy, quick-read markings
- Tough, impact resistant plastic case
- Ergonomic cushion grips for maximum comfort
- Hands-free blade lock

11124

Master: 60 Inner: 6
UPC: 8-02090-11124-2



3/8" Ratchet

- 3/8" Dr.
- Cushioned rubber handle
- Carbon steel construction

32957

Master: 48 Inner: 6
UPC: 8-02090-32957-9



6" Adjustable Wrench

32950

Master: 48 Inner: 6
UPC: 8-02090-32950-0



Multi Function Tool

- Stainless steel blades and tools
- Lightweight aluminum handle with rubber grips for comfort

32956

Master: 48 Inner: 6
UPC: 8-02090-32956-2

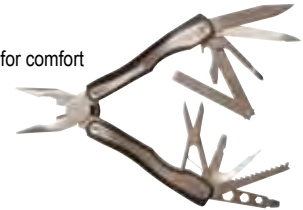

6" Slip Joint Pliers

32951

Master: 48 Inner: 6
UPC: 8-02090-32951-7



Stainless Steel Shoe Horn Wire Brush

- Ideal for removing debris and cleaning welds

41228

Master: 120 Inner: 12
UPC: 8-02090-41228-8



Adjustable Wrenches

- Heavy duty drop forged steel
- Chrome plated to resist corrosion
- Precision machined surfaces

6"	206	UPC: 8-02090-00206-9
8"	208	UPC: 8-02090-00208-3
10"	210	UPC: 8-02090-00210-6
		Master: 36 Inner: 6
12"	212	UPC: 8-02090-00212-0
		Master: 24 Inner: 6
15"	215	UPC: 8-02090-00215-1
		Master: 16 Inner: 4
18"	218	UPC: 8-02090-00218-2
		Master: 12 Inner: 12
24"	224	UPC: 8-02090-00224-3
		Master: 4 Inner: 4



Stainless Steel Wire Brush

- Ideal for removing debris and cleaning welds

41229

Master: 120 Inner: 12
UPC: 8-02090-41229-5



16" Adjustable Spud Wrench

- Chrome Vanadium construction
- Black oxide finish resists corrosion
- Opens to a maximum of 1-1/2"

216

Master: 18 Inner: 6
UPC: 8-02090-00216-8



ITEM NUMBER LISTING

ITEM NO:	DESCRIPTION:	PAGE:
206	6in Adjustable Wrench	102
208	8in Adjustable Wrench	102
210	10in Adjustable Wrench	102
212	12in Adjustable Wrench	102
215	15in Adjustable Wrench	102
216	16in Adjustable Spud Wrench	102
218	18in Adjustable Wrench	102
224	24in Adjustable Wrench	102
10997	16ft 2pk Tape Measure.....	27
10999	25ft 2pk Tape Measure.....	27
11006	22pc Titanium Drill Bit.....	38
11009	Fits-All-Phillips Screwdriver	33
11010	6-in-1 Screwdriver.....	33
11014	High Torque Ratcheting Screwdriver	33
11015	Folding Utility Knife - Red.....	28
11017	Mini Sliding Utility Knife - Yellow	28
11018	Folding Utility Knife - Blue.....	28
11020	Folding Utility Knife - Twin Pack	28
11024	Sliding Utility Knife - Yellow.....	28
11026	Readi-Blade Utility Knife	28
11027	Readi-Blade Breakaway Knife	28
11030	Multi-Purpose Razor Scraper.....	24
11031	Mini Razor Scraper	24
11032	15pc Mini Sliding Utility Knife Blades.....	28
11034	10pc Standard Utility Knife Blades	28
11035	10pc 18mm Snap-Off Knife Blades	28
11036	100pc #9 Single Edge Razor Blades	28
11038	100pc #12 Single Edge Razor Blades	28
11039	20pc Heavy Duty Razor Blades	28
11050	1/4 & 3/8in Dr. Dual Head Stubby Ratchet	5
11051	3/8 & 1/2in Dr. Stubby Ratchet	5
11054	Dual Head Stub Ratchet.....	5
11055	Stubby Gearless Ratchet Driver.....	33
11057	1/4 & 3/8in Dr. Ratchet.....	4
11058	3/8 & 1/2in Dr. Ratchet.....	4
11060	8in Stubby Adjustable Wrench	12
11061	Mini Magnetic Parts Tray.....	40
11065	3pc Utility Tool Set.....	40
11066	1/4in Dr. Swivel Head Ratchet.....	6
11067	3/8in Dr. Swivel Head Ratchet.....	6
11068	1/4in Dr. Swivel Head Extra Long Ratchet.....	6
11069	3/8in Dr. Swivel Head Extra Long Ratchet.....	6
11072	1/2in Dr. Flex Head Extra Long Ratchet.....	6
11073	3/8in Dr. Flex Head Extra Long Ratchet.....	6
11074	1/4in Dr. Flex Head Extra Long Ratchet.....	6
11075	3pc Flex Head Extra Long Ratchet Set	6
11076	3/8in Dr. Swivel Head Ratchet.....	6
11079	Heavy Duty Hacksaw	30
11080	Quick Release Close Quarter Hacksaw	30
11082	1/2in Dr. Ratchet Rebuild Kit.....	6
11083	3/8in Dr. Ratchet Rebuild Kit.....	6
11084	1/4in Dr. Ratchet Rebuild Kit.....	6
11085	1/4in Dr. Extra Long Ratchet.....	6
11086	3/8in Dr. Extra Long Ratchet.....	6
11087	1/2in Dr. Extra Long Ratchet.....	6
11088	3pc Extra Long Ratchet Set.....	6
11090	Power Spray Hose Nozzle.....	41
11091	Adjustable Water Spray Hose Nozzle	41
11094	Hori Hori Gardening Tool	41
11100	100ft Tape Measure.....	27
11112	12ft Tape Measure.....	27
11116	16ft Tape Measure.....	27
11124	25ft Tape Measure.....	102
11125	25ft Tape Measure.....	27
11126	25ft Dual Rule Tape Measure	27
11133	33ft Tape Measure.....	27
11150	165ft Tape Measure.....	27
11160	Telescoping Inspection Mirror.....	89
11161	3lbs Telescoping Magnetic Pickup Tool	89
11162	24in Flexible Claw Pickup Tool.....	40
11163	24in Flexible Magnetic Pickup Tool.....	40
11170	170pc Titanium Coated Drill Bit Set	98
11200	1/4in Dr. Gearless Micro Ratchet.....	7
11201	3/8in Dr. Gearless Micro Ratchet.....	7

ITEM NO:	DESCRIPTION:	PAGE:
11202	2pc Micro Bit Driver & Ratchet Set.....	46
11203	2pc Offset Micro Bit Driver & Ratchet Set	46
11204	1/4in Dr. Offset Micro Ratchet.....	46
11205	Offset Micro Bit Driver With Bits	46
11207	Offset Micro Bit Driver.....	46
11214	3pc Damaged Screw Removal Set	38
11219	19-in-1 Ratcheting Screwdriver	33
11230	#2 x 4in Phillips Screwdriver	32
11231	#1 x 3in Phillips Screwdriver	32
11232	1/4in x 4in Slotted Screwdriver.....	32
11233	3/16in x 3in Slotted Screwdriver.....	32
11234	T15 x 4in Torx Screwdriver	32
11235	R2 x 4in Square Screwdriver	32
11245	Slotted Screwdriver	32
11247	Screwdriver	32
11248	Slotted Screwdriver	32
11249	Slotted Screwdriver	32
11252	Screwdriver	32
11256	#1 x 3in Phillips Screwdriver	32
11260	#2 x 4in Phillips Screwdriver	32
11264	#3 x 6in Screwdriver.....	32
11267	Torx Screwdriver.....	32
11268	Torx Screwdriver.....	32
11351	3/8 & 1/2in Dr. Flex Head Stubby Ratchet.....	5
11357	1/4 & 3/8in Dr. Flex Head Ratchet.....	5
11358	3/8 & 1/2in Dr. Flex Head Ratchet.....	5
11412	7-1/2in Compound Diagonal Cutters.....	35
11448	MIG Wire Utility Pliers.....	68
11450	5" Lock Grip Pliers.....	35
11453	8" Lock Grip Pliers.....	35
11454	6" Lock Grip Long Nose Pliers	35
11460	Straight Cut Aviation Snips.....	29
11461	Right Cut Aviation Snips	29
11462	Left Cut Aviation Snips	29
11466	Right Cut Vertical Aviation Snips	30
11467	Left Cut Vertical Aviation Snips	30
11469	Adjustable Wire Stripper.....	55
11470	Compound Action Cable Cutters	30
11471	Extra Long Utility Snips	30
11472	Right Cut Offset Aviation Snips.....	30
11473	Left Cut Offset Aviation Snips	30
11475	Self Adjusting Wire Stripper	43
11477	Ratcheting Wire Terminal Crimper.....	53
11478	Wire Stripper	43
11479	Pistol Grip Wire Stripper	53
11483	3/8in Internal Pipe Wrench.....	42
11484	1/2in Internal Pipe Wrench.....	42
11485	3/4in Internal Pipe Wrench.....	42
11486	1/8in - 1/2in Tubing Bender	43
11487	Mini Tubing Bender.....	43
11488	Tubing Bending Pliers.....	43
11489	180 degree Tubing Bender.....	43
11490	1/8in - 7/8in Mini Tubing Cutter.....	42
11491	1/8in - 1-3/8in Tubing Cutter.....	42
11492	Tubing Cutter Replacement Blade	42
11493	Tubing Cutter Replacement Blade	42
11494	Chrome Tubing Cutter.....	42
11496	1/8in - 1-5/8in Tubing Cutter.....	42
11497	1/4in - 2-5/8in Tubing Cutter.....	42
11498	3pc Internal Pipe Wrench Set	42
11499	12in Basin Wrench.....	42
11500	1-1/4in Stainless Steel Scraper.....	24
11503	3in Refinishing Tool.....	26
11504	3in Offset Stainless Steel Scraper.....	24
11505	5-1/2in Mini Pry Bar.....	25
11506	5-1/2in Mini Wrecking Bar	25
11508	1-1/4in Offset Stainless Steel Scraper	24
11509	Multi-Purpose Pry Bar	25
11510	6-in-1 Painters Tool & Scraper.....	24
11512	7-1/2in Mini Pry Bar.....	25
11560	Straight Seam Splitter	31
11561	30 Degree Offset Seam Splitter	31
11562	90 Degree Angle Seam Splitter	31
11563	3pc Seam Splitter Set	31

ITEM NUMBER LISTING

ITEM NO:	DESCRIPTION:	PAGE:	ITEM NO:	DESCRIPTION:	PAGE:
11564	4pc Nylon Scraper Set.....	31	12121	12pc Assorted Knife Display	101
11565	4pc Nylon Scraper Set.....	98	12122	12pc Assorted Knife Display	101
11566	6pc Panel Removal Set.....	31	12133	12pc 13-in-1 Multi-Function Tool Display	87
11567	Super Scraper	31	12134	7-in-1 Multi-Function Tool	52
11663	Telescoping Magnetic Pickup Tool	40	12135	13-in-1 Multi-Function Tool	87
11763	3lbs Telescoping Magnetic Pickup Tool	40	12136	13-in-1 Multi-Function Tool	87
11802	12in Carbide Grit Hacksaw Blade.....	30	12139	Multi-Purpose Folding Pocket Knife	100
11817	12in Bi-Metal Hacksaw Blade.....	30	12208	8in Multi-Purpose Nail Puller & Pry Bar.....	25
11853	12in Carbon Steel Hacksaw Blades	30	12210	10in Indexable Pry Bar	26
12003	Multi-Function Tool Keychains.....	52	12212	12in Indexable Pry Bar	26
12010	6-in-1 Screwdriver.....	33	12215	15in Indexable Pry Bar	26
12012	6-in-1 Screwdriver.....	33	12216	3pc Indexable Pry Bar Set.....	26
12015	3/8in Dr. 15in Ratcheting Breaker Bar.....	8	12219	19-in-1 Ratcheting Screwdriver	33
12018	1/2in Dr. 18in Ratcheting Breaker Bar.....	8	12220	12in High Torque Ratcheting Screwdriver.....	33
12019	3/8in Dr. 18in Breaker Bar	8	12224	24in Indexable Pry Bar	26
12021	1/2in Dr. Replacement Breaker Bar Head	8	12308	8in Multi-Purpose Utility Shears	29
12022	3/4in Dr. Replacement Breaker Bar Head	8	12310	Multi-Purpose Utility Shears	29
12023	1in Dr. Replacement Breaker Bar Head	8	12340	Mini Multi-Purpose Shears.....	29
12024	1/2in Dr. 24in Ratcheting Breaker Bar.....	8	12341	Precision Shears.....	29
12025	1-1/4in Flexible Scraper.....	26	12344	All-Purpose Shears.....	101
12027	3/8in Dr. Replacement Breaker Bar Head	8	12345	7-1/2in Multi-Purpose Shears.....	29
12028	1/2in Dr. Replacement Breaker Bar Head	8	12346	5-1/2in Multi-Purpose Electrical Shears.....	29
12029	3-Position Scraper	25	12348	Multi-Purpose Offset Shears.....	29
12030	Multi-Purpose Razor Scraper.....	24	12350	1/4 & 3/8in Dr. Flex Head Stubby Ratchet.....	5
12031	Mini Razor Scraper	24	12351	1/2in x 3/8in Dual Drive Ratchet.....	5
12032	Paddle Mixer.....	98	12357	1/4in x 3/8in Dual Drive Ratchet.....	5
12033	Retractable Mini Razor Scraper.....	52	12358	1/2in x 3/8in Dual Drive Flex Head Ratchet.....	5
12037	Retractable Mini Razor Scraper	52	12440	Tinner Snips	30
12041	1/4in Dr. Ratchet Bit Driver.....	7	12447	Tinner Snips	30
12042	1/4in Dr. Offset Ratchet	4	12462	1in Carbon Scraper.....	26
12043	3/8in Dr. Offset Ratchet	4	12463	Carbon Scraper	26
12044	1/2in Dr. Offset Ratchet	4	12501	1-1/4in Flexible Scraper.....	24
12045	3/8in Dr. Offset Extra Long Ratchet.....	4	12502	2in Flexible Scraper	24
12046	1/2in Dr. Offset Extra Long Ratchet.....	4	12503	3in Flexible Scraper	24
12047	1/2in Dr. 30in Breaker Bar	8	12505	1-1/4in Offset Stainless Steel Scraper	24
12048	3/4in Dr. 40in Breaker Bar	8	12506	6mm Ratcheting Wrench.....	9
12049	1in Dr. 40in Breaker Bar	8	12507	7mm Ratcheting Wrench.....	9
12050	1/4 & 3/8in Dr. Stubby Ratchet.....	5	12508	8mm Ratcheting Wrench.....	9
12051	3/8 & 1/2in Dr. Stubby Ratchet.....	5	12509	9mm Ratcheting Wrench.....	9
12052	1/4 & 3/8in Dr. Offset Ratchet.....	5	12510	10mm Ratcheting Wrench.....	9
12053	3/8 & 1/2in Dr. Offset Ratchet.....	5	12511	11mm Ratcheting Wrench.....	9
12060	Stubby Adjustable Wrench	12	12512	12mm Ratcheting Wrench.....	9
12070	3/8in Dr. Extendable Ratchet.....	7	12513	13mm Ratcheting Wrench.....	9
12072	3/4in Dr. Extendable Ratchet.....	7	12514	14mm Ratcheting Wrench.....	9
12073	1/2in Dr. Extendable Ratchet.....	7	12515	15mm Ratcheting Wrench.....	9
12074	1/2in Dr. Extendable Ratchet.....	7	12516	16mm Ratcheting Wrench.....	9
12075	1/4in Dr. Extendable Ratchet.....	7	12517	17mm Ratcheting Wrench.....	9
12076	Adjustable Ext. Bar Set	21	12518	18mm Ratcheting Wrench.....	9
12077	Adjustable Ext. Bar Set	21	12519	19mm Ratcheting Wrench.....	9
12078	Extension Bar.....	21	12520	20mm Ratcheting Wrench.....	9
12079	3pc 3/8in Dr. Extra Long Extension Set	21	12521	21mm Ratcheting Wrench.....	9
12081	3pc 1/2in Dr. Extra Long Extension Set	21	12522	22mm Ratcheting Wrench.....	9
12082	3pc Socket Adapter Set.....	20	12524	24mm Ratcheting Wrench.....	9
12090	1/4in Dr. Finger Ratchet.....	7	12525	25mm Ratcheting Wrench.....	9
12091	3/8in Dr. Finger Ratchet.....	7	12526	27mm Ratcheting Wrench.....	9
12092	1/2in Dr. Finger Ratchet.....	7	12527	30mm Ratcheting Wrench.....	9
12093	2pc Finger Ratchet Set.....	7	12528	32mm Ratcheting Wrench.....	9
12094	3pc Indexing Ratchet Set	8	12529	34mm Ratcheting Wrench.....	9
12095	Indexing Ratchet.....	8	12601	1/4in Ratcheting Wrench	9
12096	Indexing Ratchet.....	8	12602	5/16in Ratcheting Wrench.....	9
12097	Indexing Ratchet.....	8	12603	3/8in Ratcheting Wrench	9
12098	4pc 2 Way Extension Set.....	21	12604	7/16in Ratcheting Wrench.....	9
12101	1/4in Dr. 3in Mini Ratchet	7	12605	1/2in Ratcheting Wrench	9
12102	3/8in Dr. 3in Mini Ratchet	7	12606	9/16in Ratcheting Wrench.....	9
12103	1/4 & 3/8in Dr. Mini Ratchet.....	7	12607	5/8in Ratcheting Wrench	9
12111	Multi-Purpose Folding Pocket Knife	100	12608	11/16in Ratcheting Wrench	9
12112	Multi-Purpose Folding Pocket Knife	100	12609	3/4in Ratcheting Wrench	9
12113	Multi-Purpose Folding Pocket Knife	100	12610	13/16in Ratcheting Wrench	9
12114	Multi-Purpose Folding Pocket Knife	100	12611	7/8in Ratcheting Wrench	9
12115	Multi-Purpose Folding Pocket Knife	100	12612	15/16in Ratcheting Wrench	9
12116	Multi-Purpose Folding Utility Knife	101	12613	1in Ratcheting Wrench	9
12117	Multi Purp. Folding Pocket Utility Knife.....	101	12614	1-1/16in Ratcheting Wrench.....	9
12119	Multi-Purpose Folding Utility Knife.....	100	12615	1-1/8in Ratcheting Wrench.....	9
12120	Multi Purp. Folding Pocket Utility Knife.....	100	12616	1-1/4in Ratcheting Wrench.....	9

ITEM NUMBER LISTING

ITEM NO:	DESCRIPTION:	PAGE:
12624	4pc Socket and Bit Conversion Kit.....	20
12700	10pc SAE Ball End Folding Hex Key Set.....	14
12703	9pc SAE Folding Hex Key Set.....	14
12705	9pc Metric Ball End Folding Hex Key Set.....	14
12708	7pc Metric Folding Hex Key Set.....	14
12710	10pc Tamper Resistant Star Key Set.....	14
12712	25pc Hex Key Set.....	14
12713	13pc SAE Non Slip Hex Key Set.....	15
12714	9pc MM Non Slip Hex Key Set.....	15
12715	13pc Tamper Resistant Star Key Set.....	15
12718	13pc SAE Long Arm Hex Key Set.....	15
12719	9pc Metric Long Arm Hex Key Set.....	15
12720	3pc Long Arm Hex and Star Key Set.....	15
12721	13pc SAE Ball End Hex Key Set.....	15
12722	9pc Metric Ball End Hex Key Set.....	15
12723	13pc Long Arm Star Key Set.....	15
12726	16pc SAE/Metric Hex Key Set.....	86
12727	7pc SAE Short Arm Hex Key Set.....	14
12729	9pc Metric Short Arm Hex Key Set.....	14
12733	8pc Triple Square Key Set.....	47
12734	10pc Tamper Resistant 5-Lobe Key Set.....	47
12739	39pc Star & Hex Key Set.....	14
12740	1/4in Dr. T-Handle Wrench.....	50
12742	3/8in Dr. T-Handle Wrench.....	50
12744	1/2in Dr. T-Handle Wrench.....	50
12746	4pc T-Handle Wrench Set.....	50
12748	8pc SAE T-Handle Hex Key Set.....	47
12749	8pc Metric T-Handle Hex Key Set.....	47
12751	1/4in T-Handle Bit Driver.....	50
12753	5pc SAE Swivel Hex Key Set.....	48
12754	6pc Metric Swivel Hex Key Set.....	48
12755	6pc Star Swivel Hex Key Set.....	48
12808	8mm Flex Ratcheting Wrench.....	10
12809	9mm Flex Ratcheting Wrench.....	10
12810	10mm Flex Ratcheting Wrench.....	10
12811	11mm Flex Ratcheting Wrench.....	10
12812	12mm Flex Ratcheting Wrench.....	10
12813	13mm Flex Ratcheting Wrench.....	10
12814	14mm Flex Ratcheting Wrench.....	10
12815	15mm Flex Ratcheting Wrench.....	10
12816	16mm Flex Ratcheting Wrench.....	10
12817	17mm Flex Ratcheting Wrench.....	10
12818	18mm Flex Ratcheting Wrench.....	10
12819	19mm Flex Ratcheting Wrench.....	10
12901	1/4in Flex Ratcheting Wrench.....	10
12902	5/16in Flex Ratcheting Wrench.....	10
12903	3/8in Flex Ratcheting Wrench.....	10
12904	7/16in Flex Ratcheting Wrench.....	10
12905	1/2in Flex Ratcheting Wrench.....	10
12906	9/16in Flex Ratcheting Wrench.....	10
12907	5/8in Flex Ratcheting Wrench.....	10
12908	11/16in Flex Ratcheting Wrench.....	10
12909	3/4in Flex Ratcheting Wrench.....	10
12910	13/16in Flex Ratcheting Wrench.....	10
12911	7/8in Flex Ratcheting Wrench.....	10
13520	8 x 9mm Double Box Wrench.....	11
13521	10 x 11mm Double Box Wrench.....	11
13522	12 x 13mm Double Box Wrench.....	11
13523	14 x 15mm Double Box Wrench.....	11
13524	16 x 18mm Double Box Wrench.....	11
13525	17 x 19mm Double Box Wrench.....	11
13526	5/16 x 3/8in Double Box Wrench.....	11
13527	7/16 x 1/2in Double Box Wrench.....	11
13528	9/16 x 5/8in Double Box Wrench.....	11
13529	11/16 x 3/4in Double Box Wrench.....	11
14508	8mm Reversible Ratcheting Wrench.....	10
14509	9mm Reversible Ratcheting Wrench.....	10
14510	10mm Reversible Ratcheting Wrench.....	10
14511	11mm Reversible Ratcheting Wrench.....	10
14512	12mm Reversible Ratcheting Wrench.....	10
14513	13mm Reversible Ratcheting Wrench.....	10
14514	14mm Reversible Ratcheting Wrench.....	10
14515	15mm Reversible Ratcheting Wrench.....	10
14516	16mm Reversible Ratcheting Wrench.....	10

ITEM NO:	DESCRIPTION:	PAGE:
14517	17mm Reversible Ratcheting Wrench.....	10
14518	18mm Reversible Ratcheting Wrench.....	10
14519	19mm Reversible Ratcheting Wrench.....	10
14601	1/4in Reversible Ratcheting Wrench.....	10
14602	5/16in Reversible Ratcheting Wrench.....	10
14603	3/8in Reversible Ratcheting Wrench.....	10
14604	7/16in Reversible Ratcheting Wrench.....	10
14605	1/2in Reversible Ratcheting Wrench.....	10
14606	9/16in Reversible Ratcheting Wrench.....	10
14607	5/8in Reversible Ratcheting Wrench.....	10
14608	11/16in Reversible Ratcheting Wrench.....	10
14609	3/4in Reversible Ratcheting Wrench.....	10
14610	13/16in Reversible Ratcheting Wrench.....	10
14611	7/8in Reversible Ratcheting Wrench.....	10
14612	15/16in Reversible Ratcheting Wrench.....	10
14613	1in Reversible Ratcheting Wrench.....	10
14614	7/16in Coaxial Nut Combination Wrench.....	12
15029	2.2x Magnifying Glass with LED Light.....	55
15038	2.2x Magnifying Glass.....	41
15040	Door Spring Tool.....	31
15046	Hose & Cotter Pin Remover.....	34
15060	Stepped Faucet Seat Wrench.....	53
15061	Tapered Faucet Seat Wrench.....	53
15062	Single Flare Tool.....	53
15063	PVC Pipe Cutter.....	53
15064	Plumbers Brush.....	55
15065	PVC Pipe Reamer.....	53
15066	Garbage Disposal Tool.....	53
15200	Precision Oiler.....	23
15202	8pc 3/8in Dr. Metric Spline Set.....	19
15203	8pc 3/8in Dr. SAE Spline Set.....	19
15210	3pc 3in Locking Socket Adaptor Set.....	50
15211	1/4in Dr. 3in Locking Socket Adaptor.....	50
15212	3/8in Dr. 3in Locking Socket Adaptor.....	50
15213	1/2in Dr. 3in Locking Socket Adaptor.....	50
15214	3pc 6in Locking Socket Adapter Set.....	50
15215	1/4in Dr. 6in Locking Socket Adapter.....	50
15216	3/8in Dr. 6in Locking Socket Adapter.....	50
15217	1/2in Dr. 6in Locking Socket Adapter.....	50
15220	5pc SAE Nut Driver Set.....	54
15221	5pc Metric Nut Driver Set.....	54
15222	6pc SAE Nut Driver Set.....	54
15223	6pc Metric Nut Driver Set.....	54
15224	1/2in F to 3/4in M Impact Socket Adaptor.....	20
15225	3/4in F to 1/2in M Impact Socket Adaptor.....	20
15226	3/4in F to 1in M Impact Socket Adaptor.....	20
15227	1in F to 3/4in M Impact Socket Adaptor.....	20
15230	30mm 1/2in Dr. 12pt Axle Nut Socket.....	23
15232	32mm 1/2in Dr. 12pt Axle Nut Socket.....	23
15234	34mm 1/2in Dr. 12pt Axle Nut Socket.....	23
15236	36mm 1/2in Dr. 12pt Axle Nut Socket.....	23
15239	39mm 1/2in Dr. 12pt Axle Nut Socket.....	23
15328	28mm 1/2in Dr. 6pt Axle Nut Socket.....	23
15329	29mm 1/2in Dr. 6pt Axle Nut Socket.....	23
15330	30mm 1/2in Dr. 6pt Axle Nut Socket.....	23
15331	31mm 1/2in Dr. 6pt Axle Nut Socket.....	23
15332	32mm 1/2in Dr. 6pt Axle Nut Socket.....	23
15333	33mm 1/2in Dr. 6pt Axle Nut Socket.....	23
15334	34mm 1/2in Dr. 6pt Axle Nut Socket.....	23
15335	35mm 1/2in Dr. 6pt Axle Nut Socket.....	23
15336	36mm 1/2in Dr. 6pt Axle Nut Socket.....	23
15338	38mm 1/2in Dr. 6pt Axle Nut Socket.....	23
15345	5pc 1/2in Dr. 12pt Axle Nut Socket Set.....	50
15410	T10 TR 1/4in Dr. Star Bit Socket.....	16
15415	T15 TR 1/4in Dr. Star Bit Socket.....	16
15420	T20 TR 1/4in Dr. Star Bit Socket.....	16
15425	T25 TR 1/4in Dr. Star Bit Socket.....	16
15427	T27 TR 1/4in Dr. Star Bit Socket.....	16
15430	T30 TR 1/4in Dr. Star Bit Socket.....	16
15440	T40 TR 3/8in Dr. Star Bit Socket.....	16
15445	T45 TR 3/8in Dr. Star Bit Socket.....	16
15447	T47 TR 3/8in Dr. Star Bit Socket.....	16
15450	T50 TR 3/8in Dr. Star Bit Socket.....	16
15455	T55 TR 3/8in Dr. Star Bit Socket.....	16

ITEM NUMBER LISTING

ITEM NO:	DESCRIPTION:	PAGE:
15460	T60 TR 1/2in Dr. Star Bit Socket	16
15510	T10 1/4in Dr. Star Bit Socket	17
15515	T15 1/4in Dr. Star Bit Socket	17
15520	T20 1/4in Dr. Star Bit Socket	17
15525	T25 1/4in Dr. Star Bit Socket	17
15527	T27 1/4in Dr. Star Bit Socket	17
15530	T30 1/4in Dr. Star Bit Socket	17
15540	T40 3/8in Dr. Star Bit Socket	17
15545	T45 3/8in Dr. Star Bit Socket	17
15547	T47 3/8in Dr. Star Bit Socket	17
15550	T50 3/8in Dr. Star Bit Socket	17
15555	T55 3/8in Dr. Star Bit Socket	17
15560	T60 1/2in Dr. Star Bit Socket	16
15570	T70 1/2in Dr. Star Bit Socket	16
15600	2.5mm 1/4in Dr. Hex Bit Socket	16
15601	5.5mm 1/4in Dr. Hex Bit Socket	16
15602	2mm 1/4in Dr. Hex Bit Socket	16
15603	3mm 1/4in Dr. Hex Bit Socket	16
15604	4mm 1/4in Dr. Hex Bit Socket	16
15605	5mm 1/4in Dr. Hex Bit Socket	16
15606	6mm 3/8in Dr. Hex Bit Socket	16
15607	7mm 3/8in Dr. Hex Bit Socket	16
15608	8mm 3/8in Dr. Hex Bit Socket	16
15609	9mm 3/8in Dr. Hex Bit Socket	16
15610	10mm 3/8in Dr. Hex Bit Socket	16
15611	11mm 1/2in Dr. Hex Bit Socket	16
15612	12mm 1/2in Dr. Hex Bit Socket	16
15613	13mm 1/2in Dr. Hex Bit Socket	16
15614	14mm 1/2in Dr. Hex Bit Socket	16
15615	15mm 1/2in Dr. Hex Bit Socket	16
15616	16mm 1/2in Dr. Hex Bit Socket	16
15617	17mm 1/2in Dr. Hex Bit Socket	16
15618	18mm 1/2in Dr. Hex Bit Socket	16
15619	19mm 1/2in Dr. Hex Bit Socket	16
15620	20mm 1/2in Dr. Hex Bit Socket	16
15621	21mm 1/2in Dr. Hex Bit Socket	16
15622	22mm 1/2in Dr. Hex Bit Socket	16
15650	5/64in 1/4in Dr. Hex Bit Socket	16
15651	3/32in 1/4in Dr. Hex Bit Socket	16
15652	7/64in 1/4in Dr. Hex Bit Socket	16
15653	1/8in 1/4in Dr. Hex Bit Socket	16
15654	9/64in 1/4in Dr. Hex Bit Socket	16
15655	5/32in 1/4in Dr. Hex Bit Socket	16
15656	3/16in 3/8in Dr. Hex Bit Socket	16
15657	7/32in 3/8in Dr. Hex Bit Socket	16
15658	1/4in 3/8in Dr. Hex Bit Socket	16
15659	5/16in 3/8in Dr. Hex Bit Socket	16
15660	3/8in 3/8in Dr. Hex Bit Socket	16
15661	7/16in 1/2in Dr. Hex Bit Socket	16
15662	1/2in 1/2in Dr. Hex Bit Socket	16
15663	9/16in 1/2in Dr. Hex Bit Socket	16
15664	5/8in 1/2in Dr. Hex Bit Socket	16
15665	11/16in 1/2in Dr. Hex Bit Socket	16
15666	3/4in 1/2in Dr. Hex Bit Socket	16
15667	13/16in 1/2in Dr. Hex Bit Socket	16
15668	7/8in 1/2in Dr. Hex Bit Socket	16
15669	15/16in 1/2in Dr. Hex Bit Socket	16
15670	1in 1/2in Dr. Hex Bit Socket	16
16004	Flexible Extension Bit Holder	37
16006	6in Quick Release Extension Bit Holder	37
16008	8pc Magnetic Bit Holder With Bits	37
16010	20pc Quick Release Ext. Driver & Bit Set	37
16012	12in Quick Release Extension Bit Holder	37
16013	10pc Screw Extractor/Left Hand Drill Bit	38
16014	3pc Damaged Screw Removal Set	38
16018	18in Quick Release Extension Bit Holder	37
16020	2-1/4in Quick Release Mag. Bit Holder	37
16021	Magnetic Bit Holder Display	36
16025	1in #2 Phillips Depth Setter Display	36
16026	1in R2 Square dr Depth Setter Display	36
16029	28pc Screwdriver Set	87
16032	33pc Security Bit Set	36
16034	31pc High Performance Bit Set	37

ITEM NO:	DESCRIPTION:	PAGE:
16044	45pc Bit Kit	88
16048	48pc Drill & Power Bit Set	38
16061	61pc Bit Set	36
16062	Ratcheting Ball Driver	54
16063	Ball Grip Driver	54
16064	64pc Power Bit Set	36
16067	31pc Bit and Driver Set	87
16100	100pc Security Bit Set	88
16103	3pc 1/4in Shank Magnetic Nut Setter	39
16104	4pc Socket Adapter Set	20
16105	3pc Wobble Extension Set	22
16106	3pc 6in 1/4in Shank Magnetic Nut Setter	39
16107	7pc Nut Driver Set	34
16010	20pc Quick Release Ext. Driver & Bit Set	37
16111	13pc SAE Hex Bit Set	17
16112	13pc Metric Hex Bit Set	17
16113	13pc Tamper Resistant Star Bit Set	17
16114	8pc Metric Ball End Hex Bit Set	16
16115	6pc SAE/Metric Hex Bit Set	16
16116	6pc Star Bit Socket Set	16
16117	8pc SAE Ball End Hex Bit Set	16
16118	3pc Quick Release Extension Set	22
16121	12pc Tamper Resistant Star Bit SocketSet	18
16122	13pc Star Bit Socket Set	18
16123	13pc SAE Hex Bit Socket Set	18
16124	13pc Metric Hex Bit Socket Set	18
16125	125pc Bit Kit	88
16129	9pc Star Socket Bit Set	86
16130	6pc SAE Large Hex Bit Socket Set	18
16131	7pc Metric Large Hex Bit Socket Set	18
16132	8pc SAE/Metric Large Hex Bit Socket Set	18
16133	10pc 3/8in Dr. SAE Hex Bit Socket Set	86
16134	10pc 3/8in Dr. Metric Hex Bit Socket Set	86
16135	13pc TR SAE Hex Bit Socket Set	48
16136	13pc TR Metric Hex Bit Socket Set	48
16137	13pc Tamp. Resistant Star Bit Socket Set	48
16138	9pc Stubby Triple Square Bit Socket	49
16139	9pc External Star Socket Set	86
16140	9pc Stubby SAE Hex Bit Socket Set	49
16141	9pc Stubby MM Hex Bit Socket Set	49
16142	10pc Stubby Star Bit Socket Set	50
16143	10pc TR Stubby Star Bit Socket Set	50
16144	9pc Triple Square Socket Set	48
16145	11pc TR 5-Lobe Bit Socket Set	48
16146	13pc TR SAE Hex Bit Socket Set W/Rail	48
16147	13pc TR Metric Hex Bit Socket Set W/Rail	48
16148	148pc Master Security Bit Set	36
16149	12pc Ribe Bit Socket Set	48
16150	5pc Wobble Adapter Set	50
16152	12pc Tamper Resistant Star Bit SocketSet	49
16153	13pc Star Bit Socket Set	49
16154	13pc SAE Hex Bit Socket Set	49
16155	13pc Metric Hex Bit Socket Set	49
16156	6pc SAE Large Hex Bit Socket Set	49
16157	7pc Metric Large Hex Bit Socket Set	49
16158	8pc SAE/Metric Large Hex Bit Socket Set	49
16159	13pc External Star Socket Set	49
16204	204pc Master Drill Bit Set	88
16210	2pc #2 Phillips 2in Power Bits	39
16211	2pc #2 Phillips 6in Power Bits	39
16212	5pc 1in Impact Grade Ph Power Bit Set	54
16213	2pc #2 Phillips 2in Power Bit Set	54
16215	2pc #2 Phillips 6in Power Bit Set	54
16220	2pc #2 Square Dr. 2in Power Bits	39
16221	2pc #2 Square Dr. 6in Power Bits	39
16223	5pc 1in #2 Square Power Bit Set	54
16224	2pc 2in #2 Square Power Bit Set	54
16226	2pc 6in #2 Square Power Bit Set	54
16230	2pc 2in 1/4in Slotted Power Bit Set	39
16231	2pc 6in 1/4in Slotted Power Bit Set	39
16240	2pc 2-1/2in Fits-All-Phillips Bit Set	39
16241	2pc Countersink #1 Phillips Bit Set	54
16242	2pc Countersink #2 Phillips Bit Set	54
16243	2pc Countersink #3 Phillips Bit Set	54

ITEM NUMBER LISTING

ITEM NO:	DESCRIPTION:	PAGE:
16244	8pc Countersink Bit Set.....	54
16250	2pc Drywall Depth Setter.....	36
16260	20pc 1in #2 Phillips Power Bit Set.....	39
16270	20pc 1in #2 Square Power Bit Set.....	39
16501	1/8in-1/2in #1 Step Drill Bit.....	38
16503	3pc Step Drill Set.....	38
16505	5pc Hex Shank Drill Bit Set.....	55
16541	20pc Screwdriver Bit Set.....	52
17000	3pc Scraper & Putty Set.....	24
17002	2pc Multi-Purpose Razor Scraper Set.....	24
17005	2pc Stainless Steel Pry Bar/Scraper Set.....	25
17006	2pc Mini Pry Bar Set.....	25
17007	3pc Pry Bar Set.....	25
17067	13pc Mini File Set.....	55
17101	4pc Pry Bar Set.....	26
17102	4pc Pry Bar Set.....	26
17106	6pc Punch & Chisel Set.....	41
17204	4pc Mini Screwdriver Set.....	87
17208	8pc Standard Screwdriver Set.....	32
17210	6pc Star Driver Set.....	34
17215	3pc Square Drive Set.....	33
17220	4pc Go Thru Screw Driver.....	32
17224	4pc Jumbo Bolstered Pick & Hook Set.....	34
17237	7pc Electrician Screwdriver Set.....	34
17240	10pc Screwdriver Set.....	87
17242	42pc Screw Driver Set.....	87
17247	7 pc Screwdriver Set.....	32
17308	14pc SAE Combination Wrench Set.....	46
17309	16pc Metric Combination Wrench Set.....	46
17311	11pc SAE Combination Wrench Set.....	11
17312	11pc Metric Combination Wrench Set.....	11
17313	7pc Metric Spline Drive Wrench Set.....	46
17314	7pc SAE Spline Drive Wrench Set.....	46
17316	8pc SAE Lateral Drive Wrench Set.....	47
17317	12pc Metric Lateral Drive Wrench Set.....	47
17322	22pc Raised Panel SAE & MM Wrench Set.....	84
17327	11pc SAE Raised Panel Combo Wrench Set.....	12
17328	11pc MM Raised Panel Combo Wrench Set.....	12
17329	14pc SAE Raised Panel Wrench Set.....	12
17330	16pc Metric Raised Panel Wrench Set.....	12
17350	7pc SAE Ratcheting Wrench Set.....	9
17351	7pc Metric Ratcheting Wrench Set.....	9
17352	5pc SAE Ratcheting Wrench Set.....	9
17353	5pc Metric Ratcheting Wrench Set.....	9
17354	13pc SAE Ratcheting Wrench Set.....	9
17355	12pc Metric Ratcheting Wrench Set.....	9
17356	7pc SAE Ratcheting Combo Wrench Set.....	47
17357	7pc Metric Ratcheting Combo Wrench Set.....	47
17360	7pc SAE Flex Ratcheting Wrench Set.....	11
17361	7pc Metric Flex Ratcheting Wrench Set.....	11
17364	13pc SAEReversible Ratcheting Wrench Set.....	10
17365	12pc MM Reversible Ratcheting Wrench Set.....	10
17366	13pc SAE Flex Ratcheting Wrench Set.....	11
17367	13pc Metric Flex Ratcheting Wrench Set.....	11
17370	7pc SAE Stubby Wrench Set.....	84
17371	7pc Metric Stubby Wrench Set.....	84
17382	5pc SAE Combination Wrench Set.....	47
17383	5pc Metric Combination Wrench Set.....	47
17384	5pc SAE Combination Wrench Set.....	84
17385	5pc Metric Combination Wrench Set.....	84
17394	9pc SAE Wrench Set.....	84
17395	9pc Metric Wrench Set.....	84
17396	18pc Extra Long Wrench Set.....	11
17398	22pc SAE & Metric Wrench Set.....	11
17399	30pc SAE & Metric Wrench Set.....	84
17400	21pc Exo-Drive Socket Set.....	19
17401	3/8in Dr. 5/8in Spark Plug Socket.....	19
17402	3/8in Dr. 13/16in Spark Plug Socket.....	19
17403	13pc E-Star Socket Set.....	19
17407	7pc Adapter and U-Joint Set.....	20
17408	7pc Adapter and U-Joint Set.....	20
17500	4pc Tape Measure Set.....	27
17502	2pc Combo Dual Rule Tape Measure Set.....	27
17504	4pc Tape Measure Set.....	98

ITEM NO:	DESCRIPTION:	PAGE:
17612	12pc Pick Set.....	34
17710	4pc Pick and Hook Set.....	87
18020	45pc 1/4in & 3/8in Stubby Ratchet Set.....	86
18025	3pc Quick Release Offset Ratchet Set.....	4
18180	21pc 1/4in Dr. SAE/Metric Socket Set.....	85
18181	19pc 3/8in Dr. SAE/Metric Socket Set.....	85
18182	17pc 1/2in Dr. SAE/Metric Socket Set.....	85
18190	4pc Extra Long Hex Bit Socket Set.....	17
18194	75pc Socket Set.....	85
18196	40pc Socket Set.....	85
18198	52pc Socket Set.....	85
18202	1/4in & 3/8in Dr. Gearless Micro Ratchet.....	7
18403	Convertible Int-Ext Snap Ring Plier Set.....	43
18404	4pc 6in Plier Set.....	35
18405	5pc Mini Pliers Set.....	35
18406	Mini Precision Plier Set.....	87
18450	3pc Lock Grip Plier Set.....	35
18453	5pc Lock Grip Plier Set.....	35
19000	1.4mm HVLP Gravity Feed Spray Gun.....	58
19000-14	1.4mm Needle & Nozzle Set.....	60
19000-17	1.7mm Needle & Nozzle Set.....	60
19000-20	2.0mm Needle & Nozzle Set.....	60
19000-23	2.3mm Needle & Nozzle Set.....	60
19014	1.4mm HVLP Gravity Feed Spray Gun.....	72
19018	1.8mm HVLP Gravity Feed Spray Gun.....	58
19023	2.3mm HVLP Gravity Feed Spray Gun.....	58
19100	3pc Dual Setup HVLP Spray Gun Kit.....	58
19100-14	1.4mm Needle & Nozzle Set.....	60
19100-17	1.7mm Needle & Nozzle Set.....	60
19100-20	2.0mm Needle & Nozzle Set.....	60
19100-23	2.3mm Needle & Nozzle Set.....	60
19110	1.0mm HVLP Gravity Feed Touch Up Gun.....	58
19110-01	Replacement Needles for 19110.....	58
19110-07	Metal Trigger for 19110.....	58
19112	11pc Spray Gun Cleaning Kit.....	62
19113	1.3mm Gravity Feed HVLP Spray Gun.....	59
19114	1.4mm HVLP Gravity Feed Spray Gun.....	59
19115	1.5mm HVLP Gravity Feed Spray Gun.....	59
19117	1.7mm HVLP Gravity Feed Spray Gun.....	59
19120	2.0mm HVLP Gravity Feed Spray Gun.....	59
19123	2.3mm HVLP Gravity Feed Spray Gun.....	59
19219	3pc HVLP Spray Gun Kit.....	58
19220	4pc HVLP Triple Setup Spray Gun Kit.....	59
19221	4pc HVLP Triple Setup Spray Gun Kit.....	59
19223	4pc HVLP Dual Setup Spray Gun Kit.....	60
19225	6in Orbital Sander.....	64
19226	6in Sanding Pad.....	64
19229	4pc Spray Gun Set.....	60
19296	Air Regulator.....	74
19297	Filter-Regulator Combo.....	74
19298	Filter-Regulator-Lubricator.....	74
19299	Air Regulator.....	74
19300	Filter-Regulator Combo.....	75
19301	Filter-Regulator-Lubricator.....	74
19302	2pc Disposable Inline Moisture Filters.....	62
19303	Locking Air Regulator and Gauge.....	65
19304	AMT 3-Way Composite Coupler - Female.....	65
19305	AMT 3-Way Composite Coupler - Male.....	65
19306	3pc Air Control Unit.....	75
19307	2pc Air Control Unit.....	75
19308	Air Filter.....	75
19309	Air Regulator and Gauge.....	75
19321	Ball Foot Chuck.....	76
19322	2 pc I/M Steel Male Plugs.....	76
19323	Female Ball Foot Chuck.....	76
19324	Dual Head Tire Chuck.....	76
19325	2pc I/M Steel Female Plugs.....	76
19326	I/M Steel Female Coupler.....	76
19327	Swivel Plug.....	76
19330	4pc I/M Connector Kit.....	76
19333	5pc I/M Coupler and Plug Set.....	76
19334	Female Air Chuck With Clip.....	77
19336	5pc 3in x 1/16in Cut Off Wheels.....	77
19337	7pc Blow Gun Kit.....	77

ITEM NUMBER LISTING

ITEM NO:	DESCRIPTION:	PAGE:
19338	17pc I/M Air Line Accessory Kit.....	77
19341	Air Line Inflator Gauge.....	77
19343	I/M Steel Male Coupler.....	76
19344	Tire Inflator and Dial Gauge.....	77
19345	3/8in Hose Mender.....	77
19346	3/8in Hose Ends.....	77
19352	5pc Grinding Stone Assortment.....	78
19355	4pc Air Chisel Set.....	78
19356	4pc Inflator Kit.....	76
19359	Air Adjusting Valve and Gauge.....	78
19360	Pistol Grip Nylon Blow Gun.....	66
19361	Double Male Connector.....	78
19365	1/4in x 25ft Polyurethane Air Hose.....	65
19366	1/4in x 50ft Polyurethane Air Hose.....	65
19367	1/4in x 100ft Polyurethane Air Hose.....	65
19368	1/4 x 25ft Polyurethane Recoil Air Hose.....	65
19369	1/4in Swivel Connector.....	65
19371	3/8in x 50ft PVC Air Hose.....	78
19376	3/8in x 50ft Rubber Air Hose.....	78
19377	3/8in x 50ft Hybrid Air Hose.....	78
19378	Inline Blow Gun.....	66
19380	Pocket Blow Gun.....	66
19382	3/8in x 50ft Rubber Air Hose.....	78
19385	Blow Gun Shield.....	66
19387	20in Air Blow Gun.....	66
19388	30in Air Blow Gun.....	66
19389	40in Air Blow Gun.....	66
19390	Air Dryer Gun.....	64
19390-01	Replacement Screen for the 19390.....	64
19390-02	Replacement Directional Cone for 19390.....	64
19390-03	Replacement Valve Assembly for 19390.....	64
19395	Air Dryer Stand and Hose.....	64
19397	Snub Nose Safety Blow Gun.....	79
19398	4-1/4in Professional Safety Blow Gun.....	79
19399	Low Noise Safety Blow Gun.....	79
19402	Blow Gun with Removable Venturi Tip.....	79
19418	1.8mm Siphon Feed Production Spray Gun.....	60
19419	Spot Spray Non-Aerosol Sprayer.....	66
19420	Spot Spray Rebuild Kit.....	66
19421	Twin Pack Spot Spray Set.....	79
19551	Dual Action Gravity Feed Airbrush.....	61
19552	1.5mm Air Brush Hose.....	61
19614	1.4mm Waterborne Ready HVLP Spray Gun.....	60
19614-14	1.4mm Needle and Nozzle Set.....	60
19699	19pc Air Tool Kit.....	64
19701	20pc Die Grinder Kit.....	72
19701-01	Die Grinder Re-Build Kit.....	72
19703	3in Air Cut Off Tool.....	72
19703-01	Air Cut Off Tool Re-Build Kit.....	72
19704	Air Die Grinder.....	73
19704-01	Air Die Grinder Re-Build Kit.....	73
19706	1/2in Dr. Air Impact Wrench.....	73
19706-01	Air Impact Wrench Re-Build Kit.....	73
19707	3/8in Dr. Air Ratchet.....	73
19707-01	Air Ratchet Re-Build Kit.....	73
19709	Air Hammer.....	73
19709-01	Air Hammer Re-Build Kit.....	73
19710	2pc Air Hammer Retainer Springs.....	73
19800	3pc Dual Set Up HVLP Spray Gun Kit.....	58
19900	600ml Plastic Cup & Lid.....	62
19902	2pc Plastic Lid for 150ml Paint Cup.....	62
19903	150ml Stainless Steel Paint Cup.....	62
19905	600ml Paint Mixing Cup.....	62
19906	1000ml Aluminum Paint Cup & Lid.....	62
19907	1000ml Paint Cup Replacement Lid.....	61
19908	Spray Gun Rebuild Kit for 19000 Series.....	61
19909	Spray Gun Rebuild Kit for 19100 Series.....	61
19910	Spray Gun Rebuild Kit for Touch Up Gun.....	61
19911	5pc In-Line Paint Filter.....	61
19951	17in x 2-3/4in Flexible Sanding Block.....	63
19952	5in x 2-3/4in Flexible Sanding Block.....	63
19959	7in x 4in Flexible Sanding Block.....	63
19990	Air Spray Gun Holder.....	61
19991	Magnetic Spray Gun Holder.....	61

ITEM NO:	DESCRIPTION:	PAGE:
19992	24in Air Gun & Wand.....	79
19993	36in Air Gun & Wand.....	79
19994	48in Air Gun & Wand.....	79
21002	Service Cart.....	56
21003	2 Drawer Tool Cart.....	56
21004	Folding Workbench.....	56
21006	Professional Workbench.....	56
21006-01	Replacement Hardware Kit for 21006.....	56
21007	Professional Workbench with 2 Drawers.....	56
21007-01	Replacement Hardware Kit for 21007.....	56
21010	3000lb Scissor Jack.....	13
21080	14in Lug Wrench - SAE/MM.....	82
21081	14in Folding Lug Wrench - SAE/MM.....	82
21082	20in Lug Wrench - SAE/MM.....	82
21086	22in Universal 4-Way Lug Wrench.....	82
21091	17mm 1/2in Dr. Lug Nut Socket.....	50
21092	19mm 1/2in Dr. Lug Nut Socket.....	50
21093	21mm 1/2in Dr. Lug Nut Socket.....	50
21094	22mm 1/2in Dr. Lug Nut Socket.....	50
21264	5-7/8in Round Magnetic Parts Tray.....	40
21265	Rectangular Magnetic Parts Tray.....	40
21266	Collapsible Rubber Magnetic Parts Tray.....	55
22003	Replacement Jaw for 4in Bench Vise.....	81
22004	Replacement Jaw for 4in HD Bench Vise.....	81
22005	Replacement Jaw for 5in Swivel Vise.....	81
22006	Replacement Jaw for 5in Bench Vise.....	81
22007	Replacement Jaw for 5in HD Bench Vise.....	81
22008	Replacement Jaw for 6in Bench Vise.....	81
22009	Replacement Jaw for 6in HD Bench Vise.....	81
22010	4in Bench Vise.....	81
22011	4in Heavy Duty Bench Vise.....	81
22012	5in Swivel Vise.....	81
22013	5in Bench Vise.....	81
22014	5in Heavy Duty Bench Vise.....	81
22015	6in Bench Vise.....	81
22016	6in Heavy Duty Bench Vise.....	81
22152	1/2in Dr. Electric Impact Wrench.....	79
22160	1/2in Dr. 24V Cordless Impact Wrench.....	13
22162	24V Replacement Battery.....	13
22400	Heat Gun.....	70
22501	2pc 10in Replacement Bonnets.....	71
22502	2pc 6in Replacement Bonnets.....	71
22504	11amp 7in Polisher/Sander.....	79
22508	7in Replacement Rubber Polishing Pad.....	71
22509	7in Replacement Hook & Loop Sanding Pad.....	71
22511	Flange & Wrench Set.....	71
22515	Foam Buffing Pad.....	71
22516	7-1/2in Wool Buffing Pad.....	71
22518	Bonnet Cleaning Tool.....	71
22603	Mini All-Purpose Cleaning Brush.....	89
22606	6in Random Orbital Buffer/Polisher.....	70
22610	10in Orbital Electric Polisher.....	70
22707	11amp 7in Polisher/Sander.....	70
22707-01	Replacement Motor Brushes.....	70
22707-02	Replacement Trigger.....	70
23146	1/4in Dr. Micrometer Torque Wrench.....	53
23147	3/8in Dr. Micrometer Torque Wrench.....	53
23148	1/2in Dr. Micrometer Torque Wrench.....	53
23149	3/8in Dr. Adjustable Micro Torque Wrench.....	8
23150	1/2in Dr. Reversible Torque Wrench.....	8
23151	1/2in Dr. Adjustable Micro Torque Wrench.....	8
23156	3-15 IN-LB Torque Screwdriver.....	52
23157	3-15 IN-LB Torque Screwdriver.....	52
23173	Fractional Digital Caliper.....	27
23175	Electronic Digital Caliper.....	27
30932	4pc Socket Adapter Set.....	20
30933	3pc Universal Joint Set.....	20
31096	1/4in Dr. Socket Holder.....	85
32096	1/2in Dr. Socket Holder.....	85
32097	1/2in Dr. SAE Magnetic Alum. Socket Rail.....	22
32098	1/2in Dr. Metric Mag. Alum. Socket Rail.....	22
32099	1/2in Dr. Metric Anodized Socket Holder.....	22
32130	1/2in Dr. Universal Joint.....	20
32140	3pc 1/2in Dr. Extension Set.....	21

ITEM NUMBER LISTING

ITEM NO:	DESCRIPTION:	PAGE:
32141	3pc 1/2in Dr. Wobble Extension Set.....	21
32143	1/2in Dr. 3in Extension.....	21
32145	1/2in Dr. 5in Extension.....	21
32150	1/2in Dr. 10in Extension.....	21
32157	1/2in Dr. F x 3/8in Dr. M Socket Adaptor.....	20
32158	1/2in Dr. F x 3/4in Dr. M Socket Adaptor.....	20
32948	Water Heater Socket.....	42
32950	6" Adjustable Wrench.....	102
32951	6" Slip Joint Plier.....	102
32952	5pc SAE Sockets.....	102
32953	5pc Metric Sockets.....	102
32954	5pc SAE Bit Sockets.....	102
32955	5pc Metric Bit Sockets.....	102
32956	Multi-Tool.....	102
32957	3/8" Ratchet.....	102
32958	3pc Finger Driver Set.....	46
32959	Inspection Mirror.....	55
32961	Fits-All Phillips Screwdriver.....	33
32962	Mini Magnetic Parts Tray.....	40
32963	22pc Titanium Drill Bit Set.....	38
32965	6-in-1 Screwdriver.....	33
32966	1/4in Dr. Offset Micro Ratchet.....	46
32967	Mini Razor Scraper.....	24
32968	Mini Sliding Utility Knife.....	28
32970	Pry Bar.....	25
32971	2.2x Magnifying Glass.....	41
32973	4pc Adapter Set.....	20
32974	5-1/2in Mini Wrecking Bar.....	25
32975	3pc Impact Socket Adapter Set.....	20
32976	4pc Pick and Hook Set.....	87
32977	3pc 1/4in Shank Magnetic Nut Setter.....	39
32979	Multi-Function Screwdriver/Hammer.....	52
34130	3/4in Dr. Universal Joint.....	20
34144	3/4in Dr. 4in Extension.....	21
34148	3/4in Dr. 8in Extension.....	21
34151	3/4in Dr. 16in Extension.....	21
34157	3/4in Dr. F x 1/2in Dr. M Socket Adaptor.....	20
34158	3/4in Dr. F x 1in Dr. M Socket Adaptor.....	20
34159	1in Dr. F x 3/4in Dr. M Socket Adaptor.....	20
36097	1/4in Dr. SAE Magnetic Alum. Socket Rail.....	22
36098	1/4in Dr. Metric Mag. Alum. Socket Rail.....	22
36130	1/4in Dr. Universal Joint.....	20
36142	1/4in Dr. 2in Extension.....	21
36144	1/4in Dr. 4in Extension.....	21
36146	1/4in Dr. 6in Extension.....	21
36157	1/4in Dr. F x 3/8in Dr. M Socket Adaptor.....	20
36940	3pc 1/4in Dr. Extension Set.....	21
38096	3/8in Dr. Socket Holder.....	85
38097	3/8in Dr. SAE Magnetic Alum. Socket Rail.....	22
38098	3/8in Dr. Metric Mag. Alum. Socket Rail.....	22
38130	3/8in Dr. Universal Joint.....	20
38140	3/8in Dr. 1-3/4in Extension.....	21
38143	3/8in Dr. 3in Extension.....	21
38146	3/8in Dr. 6in Extension.....	21
38148	3/8in Dr. 8in Extension.....	21
38150	3/8in Dr. 10in Extension.....	21
38152	4pc 3/8in Dr. Extension Set.....	21
38154	4pc 3/8in Dr. Wobble Extension Set.....	21
38156	3/8in Dr. 18in Extension.....	21
38158	3/8in Dr. F x 1/2in Dr. M Socket Adaptor.....	20
38159	3/8in Dr. F x 1/4in Dr. M Socket Adaptor.....	20
41185	90amp Gasless Wire Feed Welder.....	67
41221	Round Soap Stones.....	69
41222	Soap Stone Holder.....	69
41223	Welding Tip Cleaner.....	68
41224	Flint Lighter.....	69
41225	Chipping Hammer.....	68
41226	Small Brass Wire Brush.....	69
41227	Small Stainless Steel Wire Brush.....	69
41228	Stainless Steel Shoe Horn Wire Brush.....	102
41229	Stainless Steel Wire Brush.....	102
41230	1/16in Fast Fill Welding Rods.....	67
41231	5/64in General Purpose Welding Rods.....	67
41232	1/16in General Purpose Welding Rods.....	67

ITEM NO:	DESCRIPTION:	PAGE:
41233	3/32in Brass Brazing Rods.....	67
41234	1/8in Deep Penetrating Welding Rods.....	67
41235	Brazing Cutting Goggle.....	69
41236	1/8in Deep Penetrating Welding Rods.....	67
41237	1/8in General Purpose Welding Rods.....	67
41238	3/32in Deep Penetrating Welding Rods.....	67
41239	Welding Gloves.....	69
41240	.030 Mig Wire.....	68
41241	.035 Mig Wire.....	68
41242	.030 Flux Core Wire.....	68
41243	.024 Mig Wire.....	68
41244	.030 Aluminum Wire.....	68
41245	.035 Flux Core Wire.....	68
41247	Fixed Shade Welding Helmet.....	97
41250	.030 Contact Tips.....	68
41251	.035 Contact Tips.....	68
41252	Welding Nozzle.....	68
41253	Replacement Flints.....	69
41254	Auto Darkening Welding Helmet.....	97
41257	Triple Flint Lighter.....	79
41258	Replacement Flint.....	79
41260	Solar Powered Auto Dark Welding Helmet.....	97
41261	Clear Protective Replacement Lenses.....	97
41262	Solar Powered Auto Dark Welding Helmet.....	97
41263	Replacement Headgear for Welding Helmet.....	97
41264	Clear Protective Replacement Lenses.....	97
41265	Solar Powered Auto Dark Welding Helmet.....	97
41266	Solar Powered Auto Dark Welding Helmet.....	97
41267	Solar Powered Auto Dark Welding Helmet.....	98
41291	Small Magnetic Support Jig.....	68
41292	Medium Magnetic Support Jig.....	68
41293	Large Magnetic Support Jig.....	68
45200	200pc Spring Assortment.....	95
45201	270pc HNBR O-Ring Assortment.....	95
45202	407pc SAE O-Ring Assortment.....	95
45203	419pc Metric O-Ring Assortment.....	95
45204	1000pc Cotter Pin Assortment.....	90
45205	555pc Cotter Pin Assortment.....	901
45206	144pc Large Cotter Pin Assortment.....	90
45208	300pc E-Clip Assortment.....	94
45210	300pc Pin Hitch Assortment.....	90
45212	300pc Snap Ring Assortment.....	90
45214	125pc Rubber Grommet Assortment.....	95
45215	70pc Grease Fitting Assortment.....	96
45216	350pc Lock & Flat Washer Assortment.....	93
45217	110pc Copper Washer Assortment.....	94
45218	720pc Washer Assortment.....	93
45220	200pc Hex Head Screw Assortment.....	90
45221	347pc SAE Screw Assortment.....	91
45222	347pc Metric Screw Assortment.....	91
45223	150pc Nylon Locknut Assortment.....	92
45225	225pc SAE O-Ring Assortment.....	95
45227	96pc Blade Fuse Assortment.....	96
45228	500pc Aluminum Rivet Assortment.....	94
45229	96pc Mini Blade Fuse Assortment.....	96
45230	88pc Master Auto Fuse Assortment.....	96
45232	24pc Maxi Blade Fuse Assortment.....	96
45233	100pc USS Nylon Locknut Assortment.....	92
45234	240pc Wood & Metal Screw Assortment.....	92
45235	160pc SAE Hex Head Screw Assortment.....	91
45236	110pc Metric Rubber Grommet Assortment.....	95
45240	550pc Nail Assortment.....	92
45241	250pc Welding Stud Assortment.....	96
45242	100pc SAE Nylon UNF Locknut Assortment.....	92
45243	100pc Metric Nylon Locknut Assortment.....	92
45245	555pc Large SS Cotter Pin Assortment.....	90
45248	475pc Metric SS Nut & Bolt Assortment.....	91
45249	20pc Clevis Pin Assortment.....	90
45250	475pc Metric Nut & Bolt Assortment.....	91
45251	160pc Metric Hex Head Screw Assortment.....	91
45252	80pc Vacuum Cap Assortment.....	96
45274	110pc Grease Fit Assortment.....	92
45300	300pc Metric Nut Assortment.....	96
45306	106pc Hex Cap Screw Assortment.....	91

ITEM NUMBER LISTING

ITEM NO:	DESCRIPTION:	PAGE:
45307	106pc Metric Socket Screw Assortment.....	91
45330	240pc USS Nut & Bolt Assortment.....	93
45331	240pc Metric Nut & Bolt Assortment.....	93
45333	240pc Zinc USS Nut & Bolt Assortment.....	93
45334	240pc Zinc Metric Nut & Bolt Assortment.....	93
45339	158pc Wire Nut Assortment.....	96
45340	151pc Hook & Eye Screw Assortment.....	92
45341	60pc Machinery Key Assortment.....	94
45342	120pc Roll Pin Assortment.....	94
45343	295pc Shop Assortment.....	94
45348	34pc Hose Clamp Assortment.....	94
45359	71pc Clevis Pin Assortment.....	90
50013	Pocket Tire Gauge.....	89
51080	5pc 17in 80 Grit Sand Paper.....	63
51150	5pc 17in 150 Grit Sand Paper.....	63
51240	5pc 17in 240 Grit Sand Paper.....	63
51320	5pc 17in 320 Grit Sand Paper.....	63
51400	Brake Fluid Tester.....	51
51500	AC Fin Comb.....	51
51501	38pc Bore Brush Set.....	55
51613	Fuel & Air Conditioning Line Disco. Tool.....	23
51614	Fuel Line Disconnect Tool.....	23
51700	Honda/Acura Crankshaft Pulley Holder.....	23
51800	5pc Suspension Separator Kit.....	51
51801	Tie Rod Separator.....	51
51802	Ball Joint Separator.....	51
52080	5pc 5in 80 Grit Sand Paper.....	63
52150	5pc 5in 150 Grit Sand Paper.....	63
52240	5pc 5in 240 Grit Sand Paper.....	63
52320	5pc 5in 320 Grit Sand Paper.....	63
59080	Adhesive Back Wet/Dry Sandpaper 80 GRIT.....	63
59150	Adhesive Back Wet/Dry Sandpaper 150 GRIT.....	63
59240	Adhesive Back Wet/Dry Sandpaper 240 GRIT.....	63
59320	Adhesive Back Wet/Dry Sandpaper 320 GRIT.....	63
98012	12 Slot Metric Easy Carry Wrench Rack.....	12
98013	13 Slot SAE Easy Carry Wrench Rack.....	12
98017	Wallmount Wrench Holder.....	12
98022	60pc Screwdriver Display.....	32
98050	Wrench Set Pouch - SAE.....	12
98051	Wrench Set Pouch - Metric.....	12
98100	MM Ratcheting Combo Wrench Assortment.....	45
98101	SAE Ratcheting Combo Wrench Assortment.....	45
98108	Hex & Torx Bit Socket Assortment.....	44
98109	Hex & Torx Bit Socket Set Assortment.....	44

TITAN

PROFESSIONAL TOOLS



HAND TOOLS CATALOG

TITAN - Professional Tools



TITAN

PROFESSIONAL TOOL

QUALITY

Titan Professional Hand Tools feature top quality construction with eye catching appearance. Titan Hand Tools are subject to rigid manufacturing specifications. Titan's thorough and consistent quality control procedures ensure that all Titan Professional Hand Tools will deliver consistent, exceptional performance.



Socket Sets and Sockets:

Titan Socket Sets are available in a variety of drive sizes and socket styles. They feature durable, precise fitting sockets that are equipped with easy to read stamping for instant size identification. Each socket also features a knurled ring allowing for a secure grip in greasy or oily conditions.

Titan ratchets feature a smooth ratcheting action, along with very comfortable grips. These features, when coupled with the rugged, durable construction of these tools, help make tough jobs easier.

Ratchets and Drive accessories:

Titan Professional ratchets are available in various styles and drive sizes.

Features Included:

- 1/4", 3/8" & 1/2" drive sizes
- Quick or conventional release teardrop, round head, swivel head, flex-head, or offset styles
- Mini, stubby, standard, or extra long lengths
- Mirror polish finish

21pc 1/4" Dr. Fractional Socket Set

66001

- Professional Slim Head Ratchet
- 6" Spinner Handle
- 2" & 6" Extensions
- Universal Joint
- Sturdy Storage/Carry Case
- Sizes Included:
- 6 Point Sockets - 3/16, 7/32, 1/4, 9/32, 5/16, 11/32, 3/8, 7/16 & 1/2"
- 6 Point Deep Sockets - 1/4, 9/32, 5/16, 11/32, 3/8, 7/16 & 1/2"



21pc 3/8" Dr. Fractional Socket Set

68001

- Professional Slim Head Ratchet
- 1-1/2" & 6" Extensions
- Sturdy Storage/Carry Case
- Sizes Included:
- 6 Point Sockets - 1/4, 5/16, 3/8, 7/16, 1/2, 9/16, 5/8, 11/16 & 3/4"
- 6 Point Deep Sockets - 3/8, 7/16, 1/2, 9/16, 5/8, 11/16, 3/4, 13/16 & 7/8"



21pc 1/4" Dr. Metric Socket Set

66201

- Professional Slim Head Ratchet
- 6" Spinner Handle
- 2" & 6" Extensions
- Universal Joint
- Sturdy Storage/Carry Case
- Sizes Included:
- 6 Point Sockets - 4, 5, 6, 7, 8, 9, 10, 11 & 12mm
- 6 Point Deep Sockets - 6, 7, 8, 9, 10, 11 & 12mm



22pc Metric 3/8" Dr. Socket Set

68201

- Professional Slim Head Ratchet
- 3" & 6" Extensions
- 5/8" Spark Plug Socket
- Sturdy Storage/Carry Case
- Sizes Included:
- 6 Point Sockets - 10, 11, 12, 13, 14, 15, 16, 17, 18 & 19mm
- 6 Point Deep Sockets - 10, 11, 12, 13, 14, 15, 17 & 19mm



40pc 3/8" Dr. Fractional/Metric Socket Set

68203

- Professional Slim Head Ratchet
- 3" & 6" Extensions
- 5/8" Spark Plug Socket
- Sturdy Storage/Carry Case
- Sizes Included:
- 6 Point Sockets - 1/4, 5/16, 3/8, 7/16, 1/2, 9/16, 5/8, 11/16, 3/4" and 10, 11, 12, 13, 14, 15, 16, 17, 18, 19mm
- 6 Point Deep Sockets - 3/8", 7/16, 1/2, 9/16, 5/8, 11/16, 3/4, 13/16, 7/8" and 10, 11, 12, 13, 14, 15, 17, 19mm



22pc 3/8" Dr. Fractional/Metric Low Profile Socket Set

68003

- Sizes Included:
- 3/8" Dr.: 8, 9, 10, 11, 12, 13, 14, 15, 16, 17, 18 & 19mm
- 3/8" Dr.: 1/4, 5/16, 3/8, 7/16, 1/2, 9/16, 5/8, 11/16 & 3/4"

Low Profile Sockets & Ratchets provide at least an additional 3/4" of clearance



Low-Profile



Standard





Quick Release Ratchets

66101	5" Teardrop
11085	12" Extra Long (Rebuild Kit: Item#: 11084)
11074	12" Extra Long Flex Head (Rebuild Kit: Item#: 11084)



Round Swivel Head Ratchets

11066	5.5"
11068	11"

Stubby Ratchets

66113	3-5/8"
11204	3.5"
12101	3.5" with Bit Driver

1/4" Dr. Finger Ratchet

12090



3pc 1/4" Dr. Extension Set

66940

- Lengths Included: 2, 4 & 6"

66142	2"
66144	4"
66146	6"



1/4" Dr. Universal Joint

66130



1/4" Dr. Socket Rail

66000



1/4" F x 3/8" M Socket Adapter

66157



10pc Fractional 1/4" Dr. Std 6pt Socket Set

66002

- Sizes Included: 5/32, 3/16, 7/32, 1/4, 9/32, 5/16, 11/32, 3/8, 7/16 & 1/2"



10pc Metric 1/4" Dr. Std 6pt Socket Set

66202

- Sizes Included: 4, 5, 6, 7, 8, 9, 10, 11, 12 & 13mm



10pc Fractional 1/4" Dr. Deep 6pt Socket Set

66300

- Sizes Included: 5/32, 3/16, 7/32, 1/4, 9/32, 5/16, 11/32, 3/8, 7/16 & 1/2"



10pc Metric 1/4" Dr. 6pt Deep Socket Set

66400

- Sizes Included: 4, 5, 6, 7, 8, 9, 10, 11, 12 & 13mm





Quick Release Ratchets

68101	7-3/4" Teardrop
68107	7-7/8" Round
68102	11-1/2" Flexhead
11073	18" Extra Long Flexhead (Rebuild Kit: Item# 11083)
11086	18" Extra Long



Stubby Ratchets

68112	4-5/8"
12102	4"

Round Swivel Head Ratchets

11076	8-3/4"
11069	11"
11067	5-1/2"



3/8" Dr. Finger Ratchet

12091

Flex Handles

12015	15" Ratcheting (Replacement Head: Item# 12027)
68118	10"



4pc 3/8" Dr. Std Extension Set

68152
• Lengths Included: 1-3/4, 3, 6, 8"

68140	1-3/4"
68143	3"
68146	6"
68148	8"
68150	10"
68156	18"



3pc 3/8" Dr. Wobble Extension Set

68157
• Lengths Included: 1-3/4, 3, 8"



3/8" Dr. Universal Joint

68130



3pc 3/8" Dr. Extra Long Extension Set

12079
• Lengths included: 18, 24 & 30"



Socket Adapters

68158	3/8" F x 1/2" M
68159	3/8" F x 1/4" M



3/8" Dr. Socket Rail

68000



10pc 3/8" Dr. Fractional 12pt Std Socket Set

68500

- Sizes Included: 1/4, 5/16, 3/8, 7/16, 1/2, 9/16, 5/8, 11/16, 3/4, & 13/16"



10pc 3/8" Dr. Fractional 6pt Std Socket Set

68002

- Sizes Included: 1/4, 5/16, 3/8, 7/16, 1/2, 9/16, 5/8, 11/16, 3/4, & 13/16"



Fractional 3/8" Dr. Standard 6pt Sockets

68008	1/4"
68010	5/16"
68012	3/8"
68014	7/16"
68016	1/2"
68018	9/16"
68020	5/8"
68022	11/16"
68024	3/4"
68026	13/16"
68028	7/8"
68030	15/16"
68032	1"



10pc 3/8" Dr. Metric 12pt Std Socket Set

68800

- Sizes Included: 10, 11, 12, 13, 14, 15, 16, 17, 18 & 19mm



10pc 3/8" Dr. Metric 6pt Std Socket Set

68202

- Sizes Included: 10, 11, 12, 13, 14, 15, 16, 17, 18 & 19mm



Metric 3/8" Dr. Standard 6pt Sockets

68206	6mm
68207	7mm
68208	8mm
68209	9mm
68210	10mm
68211	11mm
68212	12mm
68213	13mm
68214	14mm
68215	15mm
68216	16mm
68217	17mm
68218	18mm
68219	19mm
68220	20mm
68221	21mm
68222	22mm



10pc 3/8" Dr. Fractional 12pt Deep Socket Set

68600

- Sizes Included: 1/4, 5/16, 3/8, 7/16, 1/2, 9/16, 5/8, 11/16, 3/4 & 13/16"



10pc 3/8" Dr. Fractional 6pt Deep Socket Set

68300

- Sizes Included: 1/4, 5/16, 3/8, 7/16, 1/2, 9/16, 5/8, 11/16, 3/4 & 13/16"



Fractional 3/8" Dr. 6pt Deep Sockets

68308	1/4"
68310	5/16"
68312	3/8"
68314	7/16"
68316	1/2"
68318	9/16"
68320	5/8"
68322	11/16"
68324	3/4"
68326	13/16"
68328	7/8"
68330	15/16"
68332	1"



10pc 3/8" Dr. Metric 12pt Deep Socket Set

68700

- Sizes Included: 10, 11, 12, 13, 14, 15, 16, 17, 18 & 19mm



10pc 3/8" Dr. Metric 6pt Deep Socket Set

68402

- Sizes Included: 10, 11, 12, 13, 14, 15, 16, 17, 18 & 19mm



Metric 3/8" Dr. 6pt Deep Sockets

68406	6mm
68407	7mm
68408	8mm
68409	9mm
68410	10mm
68411	11mm
68412	12mm
68413	13mm
68414	14mm
68415	15mm
68416	16mm
68417	17mm
68418	18mm
68419	19mm
68421	21mm
68422	22mm



3/8" Dr. Spark Plug Sockets

68160	5/8"
68170	9/16"
68163	3/4"
68164	13/16"
68166	14mm
68168	18mm

3/8" Dr. Universal Joint Spark Plug Sockets

68161	5/8" 3/8" Dr.
68165	13/16" 3/8" Dr.

3/8" Dr. Extended Spark Plug Sockets

68162	5/8" 3/8" Dr.
17402	13/16" 3/8" Dr.



Notes:



Quick Release Ratchets

62101	9-3/4" Teardrop
62102	17-1/2" Flex Teardrop
62106	9-3/4" Flexhead
11072	24" Extra Long Flexhead (Rebuild Kit: Item# 11082)
11087	24" Extra Long (Rebuild Kit: Item# 11082)



Flex Handles

62120	18"
62124	24"
12047	30" (Replacement Head: Item# 12021)
12018	18" Ratcheting (Replacement Head: Item# 12028)
12024	24" Ratcheting (Replacement Head: Item# 12028)



1/2" Dr. Finger Ratchet

12092

3pc 1/2" Dr. Extension Set

62140

- Lengths Included: 3, 5 & 10"



3pc 1/2" Dr. Wobble Extension Set

62141

- Lengths Included: 3, 5 & 10"



1/2" Dr. Extensions

62143	3"
62145	5"
62150	10"
62153	20"

3pc 1/2" Dr. Extra Long Extension Set

12081

- Lengths: 18, 24 & 30"



Socket Adapters

62158	1/2" F x 3/4" M
62157	1/2" F x 3/8" M



1/2" Dr. Universal Joint

62130



1/2" Dr. Socket Rail

62000



9pc 1/2" Dr. Fractional 12pt Std Socket Set

62500

- Sizes Included: 1/2, 9/16, 5/8, 11/16, 3/4, 13/16, 7/8, 15/16 & 1"



9pc 1/2" Dr. Fractional 6pt Std Socket Set

62002

- Sizes Included: 1/2, 9/16, 5/8, 11/16, 3/4, 13/16, 7/8, 15/16 & 1"



Fractional 1/2" Dr. 6pt Sockets

62012	3/8" 1/2" Dr.
62014	7/16" 1/2" Dr.
62016	1/2" 1/2" Dr.
62018	9/16" 1/2" Dr.
62020	5/8" 1/2" Dr.
62022	11/16" 1/2" Dr.
62024	3/4" 1/2" Dr.
62026	13/16" 1/2" Dr.
62028	7/8" 1/2" Dr.
62030	15/16" 1/2" Dr.
62032	1" 1/2" Dr.
62034	1-1/16" 1/2" Dr.
62036	1-1/8" 1/2" Dr.
62038	1-3/16" 1/2" Dr.
62040	1-1/4" 1/2" Dr.



9pc 1/2" Dr. Metric 12pt Std Socket Set

62800

- Sizes Included: 12, 13, 14, 15, 16, 17, 18, 19 & 22mm



9pc 1/2" Dr. Metric 6pt Std Socket Set

62202

- Sizes Included: 12, 13, 14, 15, 16, 17, 18, 19 & 22mm



Metric 1/2" Dr. 6pt Sockets

62210	10mm	62227	27mm
62211	11mm	62228	28mm
62212	12mm	62229	29mm
62213	13mm	62230	30mm
62214	14mm	62232	32mm
62215	15mm		
62216	16mm		
62217	17mm		
62218	18mm		
62219	19mm		
62220	20mm		
62221	21mm		
62222	22mm		
62223	23mm		
62224	24mm		
62225	25mm		
62226	26mm		



8pc 1/2" Dr. Fractional 6pt Deep Socket Set

62300

- Sizes Included: 1/2, 9/16, 5/8, 11/16, 3/4, 13/16, 7/8 & 15/16"



8pc 1/2" Dr. Fractional 12pt Deep Socket Set

62600

- Sizes Included: 1/2, 9/16, 5/8, 11/16, 3/4, 13/16, 7/8 & 15/16"



Fractional 1/2" Dr. Deep Sockets

6 point

62316	1/2"
62318	9/16"
62320	5/8"
62322	11/16"
62324	3/4"
62326	13/16"
62328	7/8"
62330	15/16"
62332	1"
62334	1-1/16"
62336	1-1/8"
62338	1-3/16"
62340	1-1/4"

12 point

62616	1/2"
62618	9/16"
62620	5/8"
62622	11/16"
62624	3/4"
62626	13/16"
62628	7/8"
62630	15/16"
62632	1"
62634	1-1/16"
62636	1-1/8"
62638	1-3/16"
62640	1-1/4"

1/2" DRIVE

3/4" & 1" DRIVE

8pc 1/2" Dr. Metric 6pt Deep Socket Set

62400

• Sizes Included: 12, 13, 14, 15, 16, 17, 18 & 19mm



8pc 1/2" Dr. Metric 12pt Deep Socket Set

62700

• Sizes Included: 12, 13, 14, 15, 16, 17, 18 & 19mm



Metric 1/2" Dr. Deep Sockets

6 point

62410	10mm	62422	22mm
62411	11mm	62423	23mm
62412	12mm	62424	24mm
62413	13mm	62425	25mm
62414	14mm	62426	26mm
62415	15mm	62427	27mm
62416	16mm	62428	28mm
62417	17mm	62429	29mm
62418	18mm	62430	30mm
62419	19mm	62432	32mm
62420	20mm		
62421	21mm		

12 point

62710	10mm	62722	22mm
62711	11mm	62723	23mm
62712	12mm	62724	24mm
62713	13mm	62725	25mm
62714	14mm	62726	26mm
62715	15mm	62727	27mm
62716	16mm	62728	28mm
62717	17mm	62729	29mm
62718	18mm	62730	30mm
62719	19mm	62732	32mm
62720	20mm		
62721	21mm		

Spark Plug Socket

62160	5/8"
62163	13/16"



Flex Handle

12048	3/4" Dr. x 40" (Replacement Head: Item# 12022)
12049	1" Dr. x 40" (Replacement Head: Item# 12023)



3/4" Dr Universal Joint

64130



3/4" Dr. Extensions

64144	4"
64148	8"
64151	16"

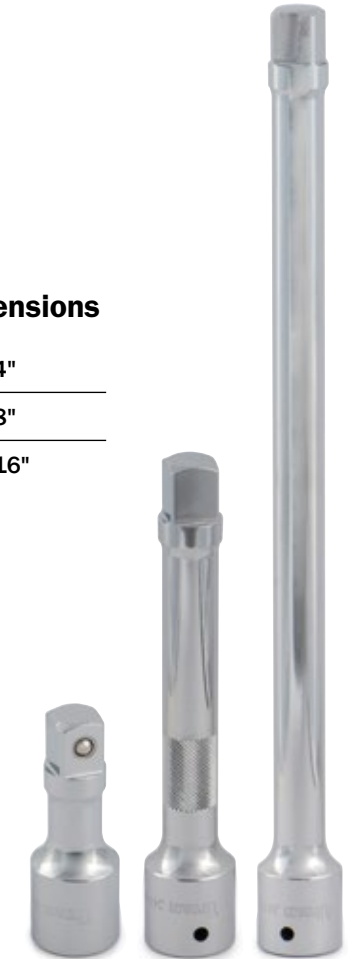

Socket Adapters

64159	1" F x 3/4" M
64158	3/4" F x 1" M
64157	3/4" F x 1/2" M



MULTI-DRIVE SETS

3pc Extra-Long Flex-Head Quick Release Ratchet Set

11075

- Contains 1/4" Dr. x 12", 3/8" Dr. x 18" & 1/2" Dr. x 24" ratchets



4" Dual Drive (1/4" Dr. x .3/8" Dr.)

12103



3pc Universal Joint Set

60933

- Sizes include: 1/4" 3/8 & 1/2 Dr.



4pc Socket Adapter Set

60934

- Sizes Included:
- 1/4" Dr. F to 3/8" Dr. M
- 3/8" Dr. F to 1/4" Dr. M
- 1/2" Dr. F to 3/8" Dr. M
- 3/8" Dr. F to 1/2" Dr. M



3pc Extra Long Ratchet Set

11088

- Drive sizes included 1/4, 3/8 & 1/2"



3pc Wobble Extension Set

16105

- Includes 3 extensions:
- 1/4" Dr. x 2"
- 3/8" Dr. x 2"
- 1/2" Dr. x 2"



1/4" Dr. & 3/8" Dr. Finger Ratchet

12093



3pc Socket Adapter Set

66156

- Sizes Included:
- 1/4" F x 3/8" M
- 3/8" F x 1/4" M
- 1/2" F x 3/8" M



7pc Adapter and U-Joint Set

17407

- 4 adapter sizes: 1/4" F to 3/8" M; 3/8" F to 1/4" M; 3/8" F to 1/2" M; 1/2" F to 3/8" M
- 3 Universal joint sizes: 1/4, 3/8 & 1/2" Dr.



4pc Socket & Bit Conversion Kit

12624

- Convert ratcheting wrenches into socket & bit driver
- Quick locking & release
- Works with 10, 13, & 19mm wrenches





Complete Hex Bit Socket Sets
Titan Hex Bit Socket Sets include a variety of sizes and styles to fit any project or job.

8pc 3/8" Dr. Fractional Hex Bit Socket Set

- 68870
- Sizes Included: 1/8, 9/64, 5/32, 3/16, 7/32, 1/4, 5/16 & 3/8"



8pc 3/8" Dr. Fractional Hex Bit Socket Set

- 68871
- Sizes Included: 1/8, 9/64, 5/32, 3/16, 7/32, 1/4, 5/16 & 3/8"
 - Impact



8pc 3/8" Dr. Metric Hex Bit Socket Set

- 68890
- Sizes Included: 3, 4, 5, 6, 7, 8, 9 & 10mm



8pc 3/8" Dr. Metric Hex Bit Socket Set

- 68891
- Sizes Included: 3, 4, 5, 6, 7, 8, 9 & 10mm
 - Impact



13pc Fractional Hex Bit Socket Set

- 16123
- Sizes include: 1/4" Dr.: 5/64, 3/32, 7/64, 1/8, 9/64, 5/32; 3/8" Dr.: 3/16, 7/32, 1/4, 5/16, 3/8; 1/2" Dr.: 7/16, 1/2"

Anodized Magnetic Rail



6pc 1/2" Dr. Fractional Hex Bit Socket Set

- 16130
- Sizes include: 9/16", 5/8", 11/16", 3/4", 13/16", 7/8"



13pc Metric Hex Bit Socket set

- 16124
- Sizes include:
 - 1/4" Dr.: 2, 2.5, 3, 4, 5, 5.5mm
 - 3/8" Dr.: 6, 7, 8, 9, 10mm
 - 1/2" Dr.: 11, 13mm



7pc 1/2" Dr. Metric Hex Bit Socket Set

- 16131
- Sizes include: 13, 14, 15, 17, 19, 21 & 22mm



8pc 1/2" Dr. Large Fractional/Metric Hex Bit Socket Set

- 16132
- Sizes include: 9/16, 5/8, 11/16, 3/4" 14mm, 15mm, 17mm, 19mm



HEX BIT SOCKETS

13pc Fractional Hex Bit Socket Set

16154

- Sizes included: 1/4" Dr.: 5/64, 3/32, 7/64, 1/8, 9/64 & 5/32"; 3/8" Dr: 3/16, 7/32, 1/4, 5/16, & 3/8"; 1/2" Dr: 7/16 & 1/2"

Reusable rail



6pc Large Fractional Hex Bit Socket Set

16156

- Sizes included: 1/2" Dr: 9/16, 5/8, 11/16, 3/4, 13/16 & 7/8"



8pc Large Fractional/Metric Hex Bit Socket Set

16158

- Sizes included: 1/2" Dr: Fractional: 9/16, 5/8, 11/16, & 3/4" 1/2" Dr: MM: 14, 15, 17 & 19mm



13pc Tamper Resistant Fractional Hex Bit Socket Set

16146

- Sizes included: 1/4" Dr: 5/64, 3/32, 7/64, 1/8, 9/64, & 5/32" 3/8" Dr: 3/16, 7/32, 1/4, 5/16, & 3/8" 1/2" Dr: 7/16 & 1/2"



8pc 3/8" Dr. Fractional Ball Tip Hex Bit Socket Set

16117

- Sizes Included: 1/8, 9/64, 5/32, 3/16, 7/32, 1/4, 5/16, 3/8" socket bits
- Ball tips allow access to fasteners in confined areas



15650	1/4" Dr. 5/64"	15660	3/8" Dr. 3/8"
15651	1/4" Dr. 3/32"	15661	1/2" Dr. 7/16"
15652	1/4" Dr. 7/64"	15662	1/2" Dr. 1/2"
15653	1/4" Dr. 1/8"	15663	1/2" Dr. 9/16"
15654	1/4" Dr. 9/64"	15664	1/2" Dr. 5/8"
15655	1/4" Dr. 5/32"	15665	1/2" Dr. 11/16"
15656	3/8" Dr. 3/16"	15666	1/2" Dr. 3/4"
15657	3/8" Dr. 7/32"	15667	1/2" Dr. 13/16"
15658	3/8" Dr. 1/4"	15668	1/2" Dr. 7/8"
15659	3/8" Dr. 5/16"	15669	1/2" Dr. 15/16"
		15670	1/2" Dr. 1"

13pc Metric Hex Bit Socket Set

16155

- Sizes included: 1/4" Dr: 2, 2.5, 3, 4, 5, & 5.5mm 3/8" Dr: 6-10mm 1/2" Dr: 11 & 12mm



7pc Large Metric Hex Bit Socket Set

16157

- Sizes included: 1/2" Dr: 13, 14, 15, 17, 19, 21 & 22mm



13pc Tamper Resistant Metric Hex Bit Socket Set

16147

- Sizes included: 1/4" Dr: 2, 2.5, 3, 4, 5, 5.5mm 3/8" Dr: 6-10mm 1/2" Dr: 11 & 12mm



8pc 3/8" Dr. Metric Ball Tip Hex Bit Socket Set

16114

- Sizes Included: 3, 4, 5, 6, 7, 8, 9 and 10mm socket bits



15602	1/4" Dr. 2mm	15612	1/2" Dr. 12mm
15600	1/4" Dr. 2.5mm	15613	1/2" Dr. 13mm
15603	1/4" Dr. 3mm	15614	1/2" Dr. 14mm
15604	1/4" Dr. 4mm	15615	1/2" Dr. 15mm
15605	1/4" Dr. 5mm	15616	1/2" Dr. 16mm
15601	1/4" Dr. 5.5mm	15617	1/2" Dr. 17mm
15606	3/8" Dr. 6mm	15618	1/2" Dr. 18mm
15607	3/8" Dr. 7mm	15619	1/2" Dr. 19mm
15608	3/8" Dr. 8mm	15620	1/2" Dr. 20mm
15609	3/8" Dr. 9mm	15621	1/2" Dr. 21mm
15610	3/8" Dr. 10mm	15622	1/2" Dr. 22mm
15611	1/2" Dr. 11mm		

STAR BIT SETS

BIT SOCKET SETS

12pc Tamper Resistant Star Bit Socket Set

16121

- Includes 1/4" Dr. TR10, TR15, TR20, TR25, TR27, and TR30 bits; 3/8" Dr. TR40, TR45, TR47, TR50, TR55 bits; and 1/2" Dr. TR60 bit



12pc Tamper Resistant Star Bit Socket Set

16152

- Sizes include: 1/4" Dr.: TR10, TR15, TR20, TR25, TR27, & TR30 3/8" Dr.: TR40, TR45, TR47, TR50, & TR55 1/2" Dr.: TR60



Tamper Resistant Star Bit Sockets

66810	TR10 1/4in Dr.
66815	TR15 1/4in Dr.
66820	TR20 1/4in Dr.
66825	TR25 1/4in Dr.
66827	TR27 1/4in Dr.
66830	TR30 1/4in Dr.
68840	TR40 3/8in Dr.
68845	TR45 3/8in Dr.
68847	TR47 3/8in Dr.
68850	TR50 3/8in Dr.
68855	TR55 3/8in Dr.
62860	TR60 1/2in Dr.



13pc Star Bit Socket Set

16122

- Includes 1/4" Dr. T10, T15, T20, T25, T27, and T30 bits; 3/8" Dr. T40, T45, T47, T50, and T55 bits; and 1/2" Dr. T60 and T70 bits



13pc Star Bit Socket Set

16153

- Sizes include: 1/4" Dr.: T10, T15, T20, T25, T27 & T30 3/8" Dr.: T40, T45, T47, T50, & T55 1/2" Dr.: T60 & T70



12pc Star Bit Socket Set

68802

- Sizes Included: 1/4" Dr.: T10, T15, T20, T-25, T-27 & T-30 3/8" Dr.: T-40, T-45, T-47, T-50 & T-55 1/2" Dr.: T-60



4pc Star Bit Socket Set

68804

- Sizes Included: T-45, T-47, T-50 & T-55 3/8" Dr.



Star Bit Sockets

66910	T10 1/4in Dr.	68945	T45 3/8in Dr.
66915	T15 1/4in Dr.	68947	T47 3/8in Dr.
66920	T20 1/4in Dr.	68950	T50 3/8in Dr.
66925	T25 1/4in Dr.	68955	T55 3/8in Dr.
66927	T27 1/4in Dr.	62960	T60 1/2in Dr.
66930	T30 1/4in Dr.	62970	T70 1/2in Dr.
68940	T40 3/8in Dr.		

9pc XZN triple Square Bit Socket Set

16144

- Sizes included: 1/4" Dr.: M4 & M5; 3/8" Dr.: M6, M8, & M10, 1/2" Dr.: M12, M14, M16, & M18



11pc Tamper Resistant 5-Lobe Bit Socket Set

16145

- Sizes included: 3/8" Dr.: IPR10, IPR15, IPR20, IPR25, IPR27, & IPR30 1/2" Dr.: IPR40, IPR45, IPR47, IPR50, IPR55



12pc Ribe Bit Socket Set

16149

- Sizes include: 1/4" Dr.: M4 & M5 3/8" Dr.: M6 - M10 1/2" Dr.: M11 - M16



13pc External Star Socket Set

16159

- Sizes included: 1/4" Dr.: E-4, E-5, E-6, E-7, E-8 3/8" Dr.: E-10, E-12, E-14, E16 1/2" Dr.: E-18, E-20, E-22, E24



13pc External Star Socket Set

17403

- Contains 1 ea of the following sizes: 1/4" Dr.: E-4, E-5, E-6, E-7, E-8; 3/8" Dr.: E-10, E-12, E-14, E-16; 1/2" Dr.: E-18, E-20, E-22, E-24
- Gold Aluminium Anodized Socket Rail
- CRV Construction
- Anodized Magnetic Base



DEEP IMPACT SOCKET SETS/ADAPTERS

IMPACT BIT SOCKET SETS

9pc 1/2" Dr. 6pt Fractional Deep Impact Socket Set

- 42300
- Sizes included: 1/2, 9/16, 5/8, 11/16, 3/4, 13/16, 7/8, 15/16 & 1"



1/2" Dr. 6pt Deep Impact Sockets

Fractional

42312	3/8"
42314	7/16"
42316	1/2"
42318	9/16"
42320	5/8"
42322	11/16"
42324	3/4"
42326	13/16"
42328	7/8"
42330	15/16"
42332	1"
42334	1-1/16"
42336	1-1/8"
42340	1-1/4"

9pc 1/2" Dr. 6pt Metric Deep Impact Socket Set

- 42400
- Sizes included: 12, 13, 14, 16, 17, 19, 21, 22 & 24mm



Metric

42410	10mm	42427	27mm
42411	11mm	42430	30mm
42412	12mm	42432	32mm
42413	13mm		
42414	14mm		
42415	15mm		
42416	16mm		
42417	17mm		
42418	18mm		
42419	19mm		
42421	21mm		
42422	22mm		
42424	24mm		
42426	26mm		

9pc 3/8" Dr. Stubby XZN Triple Square Impact Bit

- 16138
- Sizes included:
 - 1/4" Dr.: M4, M5, M6, M8, 3/8"
 - Dr.: M10, & M12, 1/2" Dr.: MT14, MT16, MT18 Tamper



9pc Hex Fractional Stubby Impact Bit Socket Set

- 16140
- Sizes included:
 - 1/4" Dr.: 1/4, 5/16, & 3/8"
 - 3/8" Dr.: 7/16, 1/2, 9/16, 5/8, 11/16 & 3/4"



9pc Stubby Metric Hex Bit Socket Set

- 16141
- Sizes included:
 - 1/4" Dr.: 6, 7, 8 & 10mm
 - 3/8" Dr.: 12, 14, 17, 18 & 19mm



10pc Star Stubby Impact Bit Socket Set

- 16142
- Sizes included:
 - 1/4" Dr.: T10, T15, T20, T25, T27 & T30
 - 3/8" Dr.: T40, T45, T47 & T50



10pc Tamper Resistant Star Stubby Impact Bit Socket Set

- 16143
- Sizes include: 1/4" Dr.: TR10, TR15, TR20, TR25, TR27 & TR30; 3/8" Dr.: TR40, TR45, TR47 & TR50



Impact Socket Adapters

15225	3/4" Dr. F x 1/2" Dr. M
15226	3/4" Dr. F x 1" Dr. M
15227	1" Dr. F x 3/4" Dr. M
42157	1/2" Dr. F x 3/8" Dr. M
48158	3/8" Dr. F x 1/2" Dr. M
42356	1/2" F to 3/4" M
42357	3/4" F to 1/2" M
42358	3/4" F to 1" M
42359	1" F to 3/4" M



IMPACT DRIVE SETS

5pc Fractional Power Nut Driver Set

15220

- Sizes 1/4, 5/16, 3/8, 7/16 & 1/2"
- 1/4" hex shank fits any standard drill chuck



5pc Metric Power Nut Driver Set

15221

- Sizes 8, 10, 12, 13 & 14mm
- 1/4" hex shank fits any standard drill chuck



6pc Fractional Power Nut Driver Set

15222

- Sizes 1/4, 5/16, 3/8, 7/16, 1/2 & 9/16"
- 1/4" hex shank fits any standard drill chuck



6pc Metric Power Nut Driver Set

15223

- Sizes 8, 10, 12, 13, 14 & 15mm
- 1/4" hex shank fits any standard drill chuck



3pc 3" Locking Socket Adapter Set

15210

- Includes 1/4, 3/8, & 1/2" Dr
- 3" length



3pc 6" Locking Socket Adapter Set

15214

- Includes 1/4, 3/8 & 1/2" Dr
- 6" length



TORQUE WRENCHES

1/4" Dr. Micrometer Torque Wrench

23146

- 20 to 200 inch-pound range



3/8" Dr. Micro Reversible Torque Wrench

23149

- 20-80 Ft-Lb (27-108 Nm)
- Easy to read analog scale window for setting torque in Pound-Feet and Newton-Meters
- Push-through drive square for accurate torque on both right and left hand threads



3/8" Dr. Micrometer Torque Wrench

23147

- 60 to 960 inch-pound range (5 - 80 ft/lbs)



1/2" Dr. Micro Reversible Torque Wrench

23150

- 20-150 Ft-Lb (27-203 Nm)
- Push-through drive square for accurate torque on both right and left hand threads



1/2" Dr. Micro Reversible Torque Wrench

23151

- 50-250 Ft-Lb (68-339 Nm)
- Easy to read analog scale window for setting torque in Pound-Feet and Newton-Meters
- Push-through drive square for accurate torque on both right and left hand threads
- Meets ANSI specifications
- Includes blow mold storage case



1/2" Dr. Micrometer Torque Wrench

23148

- 10 to 150 inch-pound range (120 - 1800 in/lbs)
- +/- 6%: 10 ~ 56 FT/LB
- +/- 4%: 56 ~ 150 FT/LB

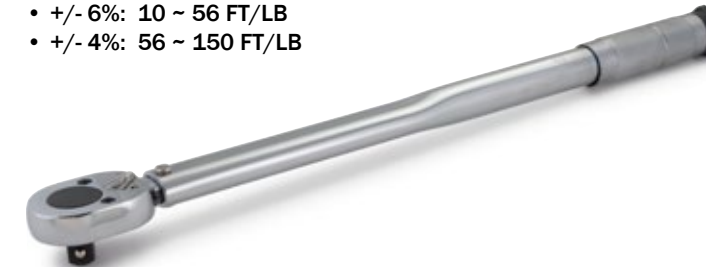

3/4" Dr. Micrometer Torque Wrench

23152

- 600 max inch-pound



COMBINATION WRENCHES

TITAN
PROFESSIONAL TOOL
QUALITY

Titan Combination and Flare Nut Wrenches are constructed from high quality chrome vanadium steel for strength and durability.

The mirror polish finish provides an appealing look to these quality wrenches. Both styles feature 15 degree offsets on the 12 point box or flare ends.

The slim body design allows for increased accessibility in tight areas. The precise, easy to read stamping makes size identification very easy.



12 Point Combination Wrenches

Fractional		Metric	
60208	1/4"	60006	6mm
60210	5/16"	60007	7mm
60212	3/8"	60008	8mm
60214	7/16"	60009	9mm
60216	1/2"	60010	10mm
60218	9/16"	60011	11mm
60220	5/8"	60012	12mm
60222	11/16"	60013	13mm
60224	3/4"	60014	14mm
60226	13/16"	60015	15mm
60228	7/8"	60016	16mm
60230	15/16"	60017	17mm
60232	1"	60018	18mm
60234	1-1/16"	60019	19mm
60236	1-1/8"	60020	20mm
60238	1-3/16"	60021	21mm
60240	1-1/4"	60022	22mm
		60023	23mm
		60024	24mm
		60025	25mm
		60026	26mm
		60027	27mm
		60028	28mm
		60029	29mm
		60030	30mm
		60032	32mm



Flare Nut Wrenches

60402	3/8 x 7/16"
60403	1/2 x 9/16"
60404	5/8 x 11/16"
60405	3/4 x 7/8"
60409	9 x 11mm
60410	10 x 12mm
60413	13 x 14mm
60415	15 x 17mm
60416	16 x 18mm
60419	19 x 21mm

RATCHETING WRENCHES

TITAN
PROFESSIONAL TOOL
QUALITY

Ratcheting Wrenches

- 72 fine-tooth ratchet design for fast performance
- Less than 5 degree sweep for use in tight spots
- Chrome vanadium steel



7pc SAE Ratcheting Combination Wrench Set

17350

- Sizes Included:
- 5/16, 3/8, 7/16, 1/2, 9/16, 5/8 & 3/4"

7pc Metric Ratcheting Combination Wrench Set

17351

- Sizes Included:
- 8, 10, 12, 13, 15, 16 & 18mm

13pc SAE Ratcheting Combination Wrench Set

17354

- Sizes Included:
- 1/4, 5/16, 3/8, 7/16, 1/2, 9/16, 5/8, 11/16, 3/4, 13/16, 7/8, 15/16 & 1"

12pc Metric Ratcheting Combination Wrench Set

17355

- Sizes Included:
- 8, 9, 10, 11, 12, 13, 14, 15, 16, 17, 18 & 19mm

Fractional	
12601	1/4"
12602	5/16"
12603	3/8"
12604	7/16"
12605	1/2"
12606	9/16"
12607	5/8"
12608	11/16"
12609	3/4"
12610	13/16"
12611	7/8"
12612	15/16"
12613	1"
12614	1 1/16"
12615	1 1/8"
12616	1 1/4"

Metric	
12506	6mm
12507	7mm
12508	8mm
12509	9mm
12510	10mm
12511	11mm
12512	12mm
12513	13mm
12514	14mm
12515	15mm
12516	16mm
12517	17mm
12518	18mm
12519	19mm
12520	20mm
12521	21mm

12522	22mm
12524	24mm
12525	25mm
12526	27mm
12527	30mm
12528	32mm
12529	34mm



Flex-Head Wrenches

- Design to reach confined areas



7pc Fractional Flex Head Ratcheting Combination Wrench Set

17360

- Sizes Included:
- 5/16, 3/8, 7/16, 1/2, 9/16, 5/8, 3/4"

13pc Fractional Flex Head Ratcheting Combination Wrench Set

17366

- Sizes Included:
- 1/4, 5/16, 3/8, 7/16, 1/2, 9/16, 5/8, 11/16, 3/4, 13/16, 7/8, 15/16 and 1"

Fractional

12901	1/4"
12902	5/16"
12903	3/8"
12904	7/16"
12905	1/2"
12906	9/16"
12907	5/8"
12908	11/16"
12909	3/4"
12910	13/16"
12911	7/8"
12912	15/16"
12914	1"

Metric

12808	8mm
12809	9mm
12810	10mm
12811	11mm
12812	12mm
12813	13mm
12814	14mm
12815	15mm
12816	16mm
12817	17mm
12818	18mm
12819	19mm

7pc Metric Flex Head Ratcheting Combination Wrench Set

17361

- Sizes Included:
- 8, 10, 12, 13, 15, 16 & 18mm

12pc Metric Flex Head Ratcheting Combination Wrench Set

17367

- Sizes Included:
- 8, 9, 10, 11, 12, 13, 14, 15, 16, 17, 18 and 19mm



Reversible Wrenches

- 15 degree offset design



13pc Fractional Reversible Ratcheting Combination Wrench Set

17364

- Sizes Included:
- 1/4, 5/16, 3/8, 7/16, 1/2, 9/16, 5/8, 11/16, 3/4, 13/16, 7/8, 15/16, & 1"

Fractional

14601	1/4"
14602	5/16"
14603	3/8"
14604	7/16"
14605	1/2"
14606	9/16"
14607	5/8"
14608	11/16"
14609	3/4"
14610	13/16"
14611	7/8"
14612	15/16"
14613	1"

12pc Metric Reversible Ratcheting Combination Wrench Set

17365

- Sizes Included:
- 8, 9, 10, 11, 12, 13, 14, 15, 16, 17, 18 & 19mm

Metric

14508	8mm
14509	9mm
14510	10mm
14511	11mm
14512	12mm
14513	13mm
14514	14mm
14515	15mm
14516	16mm
14517	17mm
14518	18mm
14519	19mm

Double Box Wrenches

Fractional

13526	5/16 x 3/8"
13527	7/16 x 1/2"
13528	9/16 x 5/8"
13529	11/16 x 3/4"

Metric

13520	8 x 9mm
13521	10 x 11mm
13522	12 x 13mm
13523	14 x 15mm
13524	16 x 18mm
13525	17 x 19mm





Titan Pliers are constructed from durable, long lasting, drop forged heat treated high carbon alloy steel.

On cutting pliers, the edges are hand sharpened to ensure a sharp, precise, even cut every time.

Titan Locking Pliers are constructed from high quality chrome vanadium steel for strength and durability.



Slip Joint Pliers

60720	6"
60721	8"
60722	10"

Diagonal Pliers

60725	6"
60726	8"



Long Nose Pliers

60731	6"
60732	6" Bent
60733	8"

Linesman Pliers

60727	8"
-------	----



Groove Joint Pliers

60741	10"
60743	12"
60745	16"

Long Reach Pliers

60771	11" Straight
60773	11" 45 Degree
60774	11" 90 Degree



Locking Pliers

60752	5" Curve Jaw
60754	7" Curve Jaw
60756	10" Curve Jaw
60758	6" Long Nose
60760	9" Long Nose
60757	10" Straight Jaw





Titan Hammers are available in many styles and sizes. Styles include Dead blow, Ball pein, Claw, Rubber, Brass, Copper, Sledge, and Cross pein. All feature comfortable, textured handles for handling ease.



Ball Pein Hammers

63308	8oz.
63312	12oz.
63316	16oz.
63016	24oz.
63024	32oz.

Dead Blow Hammers

63008	8oz.
63116	16oz.
63124	24oz.
63032	32oz.
63148	48oz.
63164	64oz.



Rubber Mallets

63217	16oz.
63232	32oz.



Non-Sparking Hammers

63048	2lb Copper
63064	3lb Copper
63216	2lb Brass
63040	3lb Brass



2.5lb Stoning Hammer

63233



3lb Sledge Hammer

63000



3lb Cross Pein Hammer

63004



16oz. Claw Hammer

63020

Steel Pipe Wrenches

21308	8"
21310	10"
21312	12"
21314	14"



SCREWDRIVERS

TITAN
PROFESSIONAL TOOL
QUALITY

Titan Screwdrivers feature chemical resistant, oversized fluted handles, and durable chrome vanadium shafts with magnetic tip.

5pc Screwdriver Set

61105

- Sizes included:
Phillips Screwdriver:
#1 & #2
Slotted Screwdriver:
3/16", 1/4" & 5/16"



Slotted Screwdrivers

60970	1/8" x 3"
60986	3/16" x 3"
60987	3/16" x 6"
60994	1/4" x 1-1/2"
60988	1/4" x 4"
60989	1/4" x 6"
60990	1/4" x 8"
60991	5/16" x 6"
60995	5/16" x 8"
60997	5/16" x 22"
60992	3/8" x 8"
60993	3/8" x 10"
60983	3/8" x 12"
60998	3/8" x 22"

Phillips Screwdrivers

60960	#0 x 3"
60961	#1 x 3"
60962	#1 x 6"
60967	#2 x 2-1/2"
60963	#2 x 4"
60964	#2 x 6"
60965	#2 x 8"
60966	#2 x 22"
60968	#3 x 6"
60971	#3 x 22"
60969	#4 x 8"

Square Screwdrivers

60890	R0 x 4"
60891	R1 x 4"
60892	R2 x 4"
60893	R3 x 4"

Star Screwdrivers

60810	T-10
60815	T-15
60820	T-20
60825	T-25
60827	T-27
60830	T-30
60840	T-40
60847	T-47



Air Tool & Accessories



Air Tools

Paint Systems

Accessories

Air Tools

19 pc Air Tool Kit

19669

- 3/8" Dr. Air Ratchet
- 1/2" Dr. Impact Wrench
- 1/2" Dr. Impact Sockets: 1/2", 9/16", 5/8", 11/16", 13/16", 10mm, 12mm, 15mm, 17mm, 19mm and 21mm.
- 3/8"F to 1/2"M Impact Socket Adapter
- 1/2" Dr. x 3" Impact Extension
- 1/4" NPT Male Industrial Plugs (2)
- Air Tool Oil
- Carry Case



20 pc Air Die Grinder Kit

19701

- 1 Straight die grinder
- 10 Assorted grinding stones
- 1 Collet
- Blow molded storage case
- 1 Angle die grinder
- 2 Connectors
- 4 Wrenches



3" Air Cut-Off Tool

19703

- Ideal for cutting sheet metals, fiberglass, bolts, muffler clamps etc.
- No-load speed: 18,000 RPM
- Includes 3" abrasive wheel, arbor wrench and allen wrench



Air Die Grinder

19704

- Ideal for light duty metal fabrication, grinding, porting and polishing applications
- Durable, lightweight composite housing design helps reduce vibration
- Lever lock throttle for safety.
- 1/4" Collet
- Includes 2 collet wrenches



1/2" Air Impact Wrench

19706

- Die cast aluminum body with rubber scuff guards on nose and back
- Reversible
- Built-in air regulator varies speed & power
- Front exhaust
- Max torque: 230 ft/lbs (310 N/m)



3/8" Air Ratchet

19707

- Light-weight aluminum body
- Forward/reverse lever conveniently located for quick direction changes
- Front exhaust blows debris away from work area.
- Compact head design allows access to confined areas
- Max torque: 45ft/lb (68N/m)



Air Hammer

19709

- Hardened steel barrel & piston
- Lightweight aluminum pistol-grip housing
- Front exhaust
- Includes the 4 most popular chisels
- 4,500 blows per minute



6" Orbital Sander

19225

- Low profile design with ergonomic grip
- Random orbital action assures a swirl-free finish
- Variable air speed control -- 5mm orbit for rapid material removal
- 6" diameter premium urethane vinyl face pad



Air Line Accessories

6" Sanding Pad

19226

- Standard replacement pad for Vaper item 19225 and other dual action sanders
- For self-adhesive abrasives
- Max operating speed: 10,000 RPM



5 pc Grinding Stone Set

19352

- 5 assorted grinding stones for Vaper 19701 die grinders and similar models with 1/4" collets
- Rated for 25,000 RPM



5 pc 3" Cut Off Wheels

19336

- 3" diameter x 1/16" thick
- Fits standard 3/8" spindle
- 25,000 RPM rating
- For use with Vaper #19703 Cut-Off Tool and other similar models



4 pc Air Chisel Set

19355

- Assortment of the 4 most popular chisels for Vaper 19709 Air Hammer and other similar models with .401" bores
- 4-3/4" overall length
- Bushing splitter, weld buster, ripping chisel and tapered punch



Female Air Chuck with Clip

19334

- 1/4" NPT (F)
- Handy clip holds chuck on tire valve until released



Ball Foot Chuck

19323

- 1/4" NPT (F)



Spot Spray Non-Aerosol Sprayers

19419 - RED Sprayer

19421 - Twin Pack

- 80-150psi operating pressure (max pressure: 200 psi)
- Refillable
- Not for use with paint products
- Eliminates dangerous or harmful propellants
- No more aerosol disposal issues
- Eco friendly
- Maximum capacity 32oz



19419

Air Adjusting Valve w/Gauge

19359

- 0 to 140 PSI gauge
- 1/4" NPT Male and female fittings



Rebuild Kit for Spot Spray Non-Aerosol Sprayer

19420

- Rebuild Kit for Vaper # 19419
- Kit includes: Pin stream Nozzle, Spray Nozzle, Head Washer, Valve Seat Adaptor, Inner Washer, Valve, Valve Spring, Black Cap, Filler Valve (Assembled together with filler cap assembly), Filler Cap Assembly, Cap Gasket, Sealing Washer, Guiding Nut, Trigger, Cotter Pin, & Trigger Liner



Air Line Inflator Gauge

19341

- 1/4" NPT (M)
- 10 - 120 PSI gauge
- Dual foot chuck



Tire Inflator/ Dial Gauge

19344

- 1/4" NPT (F)
- 0 - 160 PSI
- Locking chuck



Air Line Accessories

17 pc Air Accessory Kit

19338

- Blow Gun
- (2) 1/4" NPT brass double male connectors
- 1/4" NPT double female connector
- 6" offset dual-head tire chuck
- Tire pressure gauge
- 1/4" NPT Brass female coupler
- (2) 1/4" NPT female plugs
- (4) 1/4" NPT male plugs
- Sports ball inflator and adaptor
- Inflatable toy inflator and safety adaptor



4 pc Air Inflator Kit

19356

- Use to inflate tires, air mattresses and sports equipment
- Includes inflation adapter, tapered inflation nozzle, inflation needle, and tire nozzle



7 pc Blow Gun Kit

19337

- Blow gun with 6 accessory attachments:
- 3-3/4" extension
- Rubber tip
- Sports ball inflator and adaptor
- Inflatable toy inflator and safety adaptor



Dual Head Tire Chuck

19324

- 1/4" NPT Female
- 6" overall length
- Offset dual head



Air Hammer Retainer Spring

19710

- Replacement retainer spring for item 19709



Connectors, Plugs and Couplers

2 pc Male Plugs

19322

- (2) 1/4" NPT Male Quick-connect fittings



2 pc Female Plugs

19325

- (2) 1/4" NPT Female Quick-connect fittings



Double Male Connector

19361

- 1/4" NPT Male adapter allows 2 Female accessories to be connected



Air Line Couplers

19326 - 1/4" NPT Female

19343 - 1/4" NPT Male

- Attaches to end of air hose to connect to air tools and accessories equipped with plugs



4 pc Quick Connector Kit

19330

- Includes 1/4" NPT:
- Steel female coupler
- Male plug
- Female plug
- Double male connector



5 pc Coupler and Plug Set

19333

- Includes 1/4" NPT:
- Steel female coupler
- (4) Male plugs



AMT 3-Way Composite Couplers

19304 - Female / 19305 - Male

- Accepts the 3 most popular 1/4" nipple styles:
 - A Style: ARO 210 style
 - M Style: Milton or industrial style
 - T Style: Tru-Flate/Parker Automotive style
- Light and durable nylon construction
- Maximum working pressure: 210 PSI

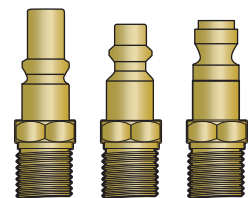

Fits A, M and T style fittings

Air Line Accessories

Air Hose & Blow Guns

1/4" x 25 ft. Polyurethane Recoil Air Hose

19368

- 1/4" NPT brass fittings with swivel-action to keep hose free of kinks
- High visibility yellow color for a safer workplace
- Oil-proof and abrasion & corrosion resistant
- 120 PSI working pressure



4" Air Blow Gun

19360

- Variable air pressure control
- Allows for quick removal of dust and dirt particles from hard to reach places
- Durable plastic body and stainless steel nozzle



Blow Gun Chip Shield

19385

- Attaches to blow gun nozzle to prevent blow-back material out of operator's eyes



3/8" x 50' PVC Air Hose

19371

- Resists gasoline, oil and other automotive liquids
- Premium grade hose with bend restrictors at each end for prolonged life
- Includes 1/4" NPT male fittings at each end
 - Working pressure: 300 PSI
 - Burst pressure: 1,200 PSI



Long Nozzle Air Blow Gun

19387 - 20"

19388 - 30"

19389 - 40"

- Variable air pressure control
- Allows for quick removal of dust and dirt particles from hard to reach places
- Durable plastic body and steel nozzle with brass threaded air inlet

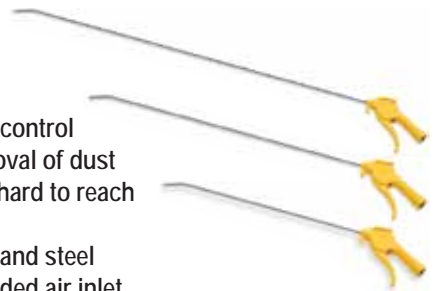

3/8" x 50' Hybrid Air Hose

19377

- Blended rubber and PVC hose is extremely light weight and flexible
- Bend restrictors at each end for prolonged life
- Resists kinking and curling
- Includes 1/4" NPT male fittings at each end
- Working pressure: 300 PSI
- Burst pressure: 1,200 PSI



Inline Blow Gun

19378

- Allows quick access
- Includes rubber safety tip
- 1/4" NPT Threads



Pocket Blow Gun

19380

- Lightweight anodized aluminum
- Twist action adjustable valve for better air control
- Fits standard 1/4" air couplers



Polyurethane Air Hoses

19365 - 25ft.

19366 - 50ft.

19367 - 100ft.

- 1/4" NPT brass fittings with swivel-action to keep hose free of kinks
- Up to 50% lighter than standard rubber air hoses
- Durable braided polyurethane construction with abrasion resistant finish



Air Hose Accessories

1/4" Swivel Connector

19369

- Convenient for all air tools
- Air flow control knob
- Working pressure: 90 PSI (6Kg/cm²)
- Increases hose life by preventing twists & kinks



3/8" Hose Mender - 19345

-(IMAGES NOT AVAILABLE)

3/8" Hose Ends, 1/4" NPT - 19346

-(IMAGES NOT AVAILABLE)

Professional Blow Guns

Snub Nose Safety Blow Gun

Item# 19397



4 1/2" Professional Safety Blow Gun

Item# 19398



Low-Noise Safety Blow Gun

Item# 19399



- **Extremely Quiet**
 - Noise Reduced tips ensure less noise than standard blow guns
- **Stainless Steel**
 - Stainless steel eliminates corroding or material blemishes
- **OSHA Compliant**
 - OSHA STD 1910-95 & OSHA STD 1-13.1
 - Nitrile rubber seal
 - Variable speed trigger
 - 1/4" NPT (F)
 - Durable brass threading
 - Scratch resistant rubber tip



Part#:	Noise level at 100psi:	Air consumption at 100psi:	Blowing force at 100psi:	Operating Pressure:	Operating Temperature:
19397	77db (OSHA compliant)	15.89 cfm	.83lbs	50psi-235psi	14F -158F
19398	80db (OSHA compliant)	15.18 cfm	.76lbs	50psi-235psi	14F -158F
19399	75db (OSHA compliant)	13.42 cfm	.31lbs	50psi-235psi	14F -158F



**ALWAYS WEAR EYE PROTECTION
THAT COMPLIES WITH ANSI
STANDARD**

NEW!

Filter-Regulator-Lubricators

FRL's in 3 Popular Sizes: 1/4, 3/8 & 1/2"

Air-Filter-Regulators

19306-19309: 1/4" • 19296-19298: 3/8" • 19299-19301: 1/2"

- Maintains steady outlet pressure, unaffected by variations / fluctuations in the inlet pressure
- Aluminum die cast construction with a Non raising "Press to Lock" adjusting knob for locking at any set pressure
- Can be installed in any position (horizontal / vertical etc.)
- Modular mounting systems allows for removal of components without disturbing the pipe line

1/4" FRL's

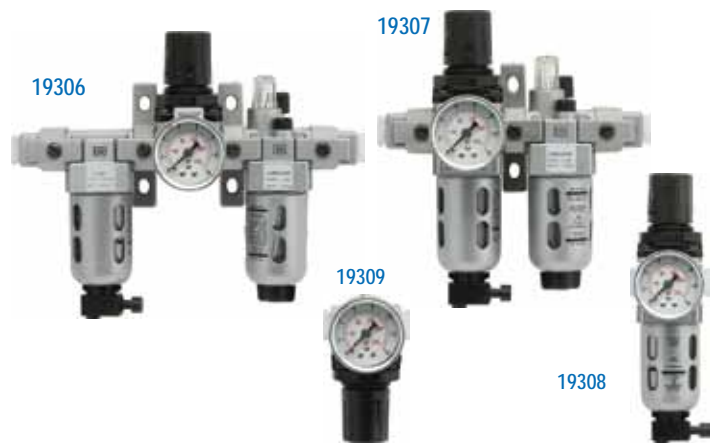

3/8" FRL's



1/2" FRL's

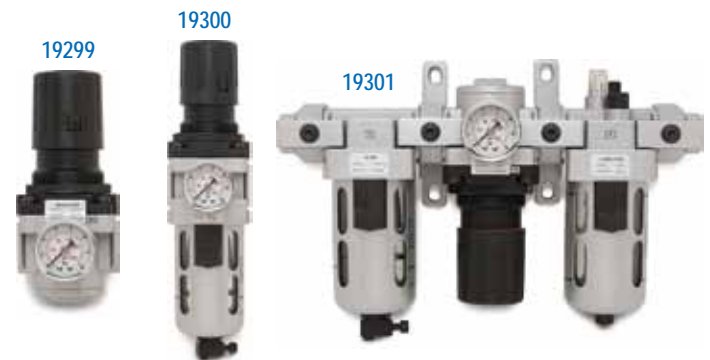

Item#:	Inlet/Outlet Port Size:	Pressure Gauge Port Size:	Max Pressure (PSI / BAR):	Maximum Flow Rate:	Pressure Adjustment Range:
19296	3/8"	1/8"	220PSI / 15 BAR	88 CFM	7 to 200
19297	3/8"	1/8"	145PSI / 10 BAR	64 CFM	7 to 145 PSI
19298	3/8"	1/8"	145PSI / 10 BAR	71 CFM	7 to 145 PSI
19299	1/2"	1/8"	220PSI / 15 BAR	140 CFM	7 to 200 PSI
19300	1/2"	1/8"	145PSI / 10 BAR	106 CFM	7 to 145 PSI
19301	1/2"	1/8"	145PSI / 10 BAR	123 CFM	7 to 145 PSI
19306	1/4"	1/8"	145PSI / 10BAR	48 CFM (1350 LPM)	7 to 145 PSI
19307	1/4"	1/8"	145PSI / 10 BAR	18 CFM (500 LPM)	7 to 145 PSI (0.5 to 10 BAR)
19308	1/4"	1/8"	145 PSI / 10 BAR	20 CFM (550 LPM)	7 to 145 PSI (0.5 to 10 BAR)
19309	1/4"	1/8"	220PSI / 15 BAR	21 CFM (600 LPM)	7 to 145 PSI (0.5 to 10 BAR)

Spray Guns

19000 Series Spray Guns

Gravity Feed H.V.L.P. Spray Guns

19000 1.4 mm, blue body

19018 1.8 mm, red body

19023 2.3mm, green body

- Locking pressure regulator with gauge
- Includes locking air regulator with gauge
- Air Consumption: 7.0 - 9.0 CFM
- Stainless steel needle
- Air Inlet: 1/4"
- 600cc plastic paint cup
- Brass Fluid & Air Nozzle



19100 Series Spray Guns

3 pc Dual Set-Up H.V.L.P. Spray Gun Set

19100

Set includes:

- (1) 1.4mm needle and nozzle set for lighter materials
- (1) 1.7mm needle and nozzle set for heavier materials
- (1) Locking Pressure regulator with gauge



H.V.L.P. Touch-Up Spray Gun

19110

- 1.0 mm touch up gun
- 100 cc Aluminum paint cup
- Ships in reusable storage tray
- Includes cleaning kit with maintenance tools



Gravity Feed H.V.L.P. Spray Guns

19113 1.3mm Needle & Nozzle

19114 1.4mm Needle & Nozzle

19115 1.5mm Needle & Nozzle

19117 1.7mm Needle & Nozzle

19120 2.0mm Needle & Nozzle

19123 2.3mm Needle & Nozzle

- Includes locking pressure regulator with gauge
- 1000 ml aluminum paint cup
- Spray pattern control knob on side of guns
- Air Inlet: 1/4"
- Operating pressure: 15 - 45 P.S.I.
- Avg. Air consumption: 7.0 - 9.0 C.F.M.



19200 Series Spray Guns

4 pc H.V.L.P. Color-Coded Triple Set-Up Spray Gun Kit with Case

19221

Green Gun - 1.0 mm nozzle

Red Gun - 1.4mm nozzle

Blue Gun - 1.7mm nozzle

Locking pressure regulator with gauge

Bonus aluminum storage/carry case



4pc HVLP Triple Set-Up Spray Gun Kit

19220

(1) 1.0 mm nozzle set for touch up work

(1) 1.4mm nozzle set for lighter materials

(1) 1.7mm nozzle set for heavier materials

(1) Locking pressure regulator with gauge



Spray Guns

19200 Series Spray Guns cont.

3 pc H.V.L.P. Dual Set-Up Spray Gun Kit

19219

- (1) 1.0 mm for touch up work
- (1) 1.4 mm for bases and clear coats
- (1) Locking pressure regulator with gauge

Features and Specs:

- Aluminum paint cups
- 2-Step trigger control
- Non-bleeder type, gravity feed external mix
- Stainless steel nozzles
- Adjustable spray width, air inlet and fluid outlet



4 pc H.V.L.P. Dual Set-Up Spray Gun Kit

19223

Gun A - 1.4 mm production gun / Gun B - 1.7mm production gun

- Locking pressure regulator with gauge
- 6" Random orbital sander for paint prep and finishing applications
- Mesh filters for gravity feed paint cups
- 2 spray gun wrenches
- Cleaning brush



4 pc H.V.L.P. Triple Set-Up Spray Gun Kit with Case

19229

Set Includes:

- Blue Gun - 1.0 mm nozzle set for lighter materials and touch up work
- Red Gun - 1.4mm nozzle set for lighter materials
- Green Gun - 1.7mm nozzle set for heavier materials
- Locking pressure regulator with gauge
- Bonus storage/carry case

All Guns:

- Spun aluminum paint cups
- Die cast aluminum body
- 2-Step trigger control
- Non-bleeder type, gravity feed external mix
- Stainless steel nozzles
- Adjustable spray width, air inlet and fluid outlet



Additional Spray Guns

1.4mm Gravity Feed HVLP Spray Gun

19014

- Unlike siphon feed guns, gravity feed guns ensure virtually 65-85% material usage
- Lightweight aluminum paint cup
- Stainless steel needle and nozzle set resists corrosion and wear from abrasive materials
- Air valve for precise air flow adjustment
- Includes pressure regulator and cleaning kit



Dual Action Gravity Feed Airbrush

19551

- Balanced, lightweight design with chrome plated finish
- Dual action trigger for greater control - press down for air; pull back for paint
- For use with automotive or water based paints



1.5mm Air Brush Hose

19552 - (IMAGE NOT AVAILABLE)

3pc Dual Set-Up HVLP Spray Gun Kit

19800

Set includes:

- (1) 1.4mm set for lighter materials
- (1) 1.7mm set for heavier materials
- (1) Locking Pressure regulator with gauge
 - 1000 ml aluminum paint cups
 - Air Inlet: 1/4"
 - Operating pressure: 15 - 45 P.S.I.
 - Avg. Air consumption: 7.0 - 9.0 C.F.M.



Siphon Feed Production Spray Gun

19418

- Fully adjustable spray pattern
- 1.8 mm needle and nozzle set for heavier materials
- Non bleeder type, siphon feed
- External mix for fine atomization
- Spun aluminum 1 liter canister



Spray Gun Accessories

Gravity Feed Paint Cups

19900, 19903 & 19906

19900 - Plastic, 600ml capacity

- Fits VAPER 19000 Series production spray guns

- Includes vented screw-on lid

19903 - Stainless Steel, 150ml capacity

19906 - Aluminium, 1000ml capacity

- Fits VAPER 19100 & 19200 Series production spray gun

- Includes snug fitting press fit lid



19906



19903



19900

Paint Cup Replacement Lids

19902 & 19907

- Snug fitting press fit

19902

- Fits 150ml capacity stainless steel paint cup

- Fits VAPER 19100 & 19200 Series touch-up spray guns

19907

- Fits 1000ml capacity stainless steel paint cup

- Fits VAPER 19100 & 19200 Series production spray guns



5 pc In-line Filter Screens

19911

- Genuine VAPER Replacement Part

- Fits all VAPER Gravity feed spray guns

- In-line mesh filter removes dirt particles from paint to protect against defects

- Insert into gravity feed spray gun fluid inlet prior to cup installation



Magnetic Spray Gun Holder

19991

- Provides convenient storage of gravity feed spray guns when not in use

- Attaches to spray booth walls, work stations, tool boxes or any metal surface

- Vinyl coated hooks protect spray gun finish from scratches
- Spray gun not included



Spray Gun Cleaning Kit

19112

- Ideal for cleaning all types of paint spray guns

- Maintain your spray guns and keep them lasting longer

- Brushes can be used with all types of paint thinners and spray gun cleaning solvents

- Designed to clean gun and all fluid and air passages without damage



Spray Gun Holder

19990

- Heavy duty steel construction

- Funnel holder over paint cup for easy filling



Disposable Inline Moisture Filters

19302

- Helps reduce painting defects

- Removes moisture, oil vapor and rust particles that pass through conventional filters

- Mounts at spray gun for best protection

- High flow design minimizes pressure drop to spray gun



1/4" Locking Pressure Regulator with Gauge

19303

- Small & lightweight

- Attaches to all conventional and HVLP spray guns



20 oz. Paint Mixing Cup

19905

- Works with Vaper gravity feed paint guns

- Translucent design with measurement scale for accurate mixing

- Durable polyethylene plastic for long life

- Includes cup, base stand, caps and coupler

- Cup capacity: 600ml



Spray Gun Accessories

Needle & Nozzle Sets



For 19000 Series Spray Gun:

- 19000-14 (1.4mm)
- 19000-17 (1.7mm)
- 19000-20 (2.0mm)
- 19000-23 (2.3mm)

For 19100 & 19200 Series Spray Gun:

- 19100-14 (1.4mm)
- 19100-17 (1.7mm)
- 19100-20 (2.0mm)
- 19100-23 (2.3mm)
- 19110-01 (1.0mm) touch up

Spray Gun Re-Build Kits



- 19908 - Fits 19000 series Production Spray Guns
- 19909 - Fits 19100 & 19200 series Production Spray Guns
- 19910 - Fits 19100 & 19200 series Touch-Up Guns
- Extends the life of your spray guns
- Includes all parts needed for a rebuild

Waterborne Paint Systems

Air Dryer Gun Stand

19395

- Securely holds 2 air dryer guns (not included)
- Air dryer gun rotates 360° and locks in any position
- Includes 2 90 PSI air hoses
- Adjustable height up to 82" and width up to 34"
- Steel construction with brass air couplers



Waterborne Ready HVLV Production Spray Gun

19614

- 1.4 mm needle and nozzle for high quality bases and clear coats
- Fast working speed and wide pattern
- Stainless steel needle and fluid tip
- 600ml plastic paint cup
- Cleaning kit included



19614-14

- 1.4mm Needle & Nozzle Set
- (IMAGE NOT AVAILABLE)

Air Dryer Gun

19390

- Speeds drying time of waterborne industrial coatings
- Variable air flow provides drying flexibility
- Includes intake filter to stop flying debris
- Working air pressure: 2-4 bar
- Max air pressure: 12 bar
- Air consumption at 4 bar: 350 L/min
- Weight: 460g
- Sound pressure at 4 bar: 72dB



Air Dryer Gun Replacement Parts

19390-01

- Replacement Screen

19390-02

- Replacement Directional Cone

19390-03

- Replacement Valve Assembly



PART NUMBER LISTING

PART NO.	DESCRIPTION	MASTER / INNER	UPC - CHECK DIGIT
19000	HVLP GRAVITY FEED SPRAY	10/1	802090-19000 -1
19000-14	1.4MM NEEDLE & NOZZLE SET	1/1	
19000-17	1.7MM NEEDLE & NOZZLE SET	1/1	
19000-20	2.0MM NEEDLE & NOZZLE SET	1/1	
19000-23	2.3 NEEDLE & NOZZLE SET	1/1	
19018	HVLP GRAVITY FEED SPRAY GUN	10/1	802090-19018 -6
19023	HVLP GREEN SPRAY GUN 2.3M	10/1	802090-19023 -0
19100	3PC DUAL SETUP HVLP SPRAY GUN KIT	5/1	802090-19100 -8
19100-14	1.4MM NEEDLE & NOZZLE FOR 19100	1/1	
19100-17	1.7MM NEEDLE & NOZZLE SET FOR 19100	1/1	
19100-20	2.0MM NEEDLE & NOZZLE SET FOR 19100	1/1	
19100-23	2.3MM NEEDLE & NOZZLE	1/1	
19110	HVLP TOUCH UP GUN 1.0MM	5/1	802090-19110 -7
19110-01	REPLACEMENT NEEDLES FOR 19110	1/1	
19112	SPRAY GUN CLEANING KIT, 11PC	48/6	802090-19112 -1
19113	1.3MM GRAVITY FEED HVLP SPRAY GUN	5/1	802090-19113 -8
19114	1.4MM HVLP CHROME SPRAY GUN	5/1	802090-19114 -5
19115	1.5MM GRAVITY FEED HVLP SPRAY GUN	5/1	802090-19115 -2
19117	1.7MM GRAVITY FEED HVLP SPRAY GUN	5/1	802090-19117 -6
19120	2.0MM GRAVITY FEED HVLP SPRAY GUN	5/1	802090-19120 -6
19123	2.3MM HVLP CHROME SPRAY GUN	5/1	802090-19123 -7
19219	3PC HVLP SPRAY GUN KIT	5/1	802090-19219 -7
19220	4PC HVLP TRIPLE SETUP SPRAY GUN KIT	5/1	802090-19220 -3
19221	4PC HVLP TRIPLE SETUP SPRAY GUN KIT	3/1	802090-19221 -0
19223	4PC HVLP DUAL SETUP SPRAY GUN KIT	3/1	802090-19223 -4
19225	6IN ORBITAL SANDER	10/1	802090-19225 -8
19226	6IN SANDING PAD	10/1	802090-19226 -5
19229	4PC SPRAY GUN SET	3/1	802090-19229 -6
19302	DISPOSABLE INLINE MOISTURE FILTERS, 2PC	48/6	802090-19302 -6
19303	AIR REGULATOR/GAUGE, LOCKING, 1/4IN NPT	48/6	802090-19303 -3
19304	AMT 3-WAY COMPOSITE COUPLER(FEMALE)	10/200	802090-19304 -0
19305	AMT 3-WAY COMPOSITE COUPLER(MALE)	10/200	802090-19305 -7
19322	MALE PLUG, I/M 1/4IN NPT, STEEL	192/12	802090-19322 -4
19323	BALL FOOT CHUCK, 1/4IN NPT, FEMALE	192/12	802090-19323 -1
19324	TIRE CHUCK, DUAL HEAD	96/12	802090-19324 -8
19325	FEMALE PLUG, I/M, 1/4IN NPT, STEEL	192/12	802090-19325 -5
19326	FEMALE COUPLER, I/M 1/4IN NPT, STEEL	192/12	802090-19326 -2

PART NUMBER LISTING

PART NO.	DESCRIPTION	MASTER / INNER	UPC - CHECK DIGIT
19330	CONNECTOR KIT, I/M 1/4IN NPT 4PC	96/12	802090-19330 -9
19333	COUPLER AND PLUG SET, I/M, 1/4IN NPT	48/6	802090-19333 -0
19334	FEMALE AIR CHUCK/CLIP	192/12	802090-19334 -7
19336	CUT OFF WHEELS, 3IN X 1/16IN, 5PC	192/12	802090-19336 -1
19337	BLOW GUN KIT, 1/4IN NPT, 7PC	36/6	802090-19337 -8
19338	AIR LINE ACCESSORY KIT, I/M, 1/4IN NPT	24/6	802090-19338 -5
19341	AIR LINE INFLATOR GAUGE	24/6	802090-19341 -5
19343	MALE COUPLER, I/M 1/4IN NPT, STEEL	192/12	802090-19343 -9
19344	TIRE INFLATOR/DIAL GAUGE	24/6	802090-19344 -6
19345	3/8IN HOSE MENDER	192/12	802090-19345 -3
19346	3/8 HOSE ENDS, 1/4IN NPT	192/12	802090-19346 -0
19352	GRINDING STONE ASSORTMENT, 5PC	72/12	802090-19352 -1
19355	AIR CHISEL SET, 4PC	36/6	802090-19355 -2
19356	INFLATOR KIT, 4PC	12/192	802090-19356 -9
19359	AIR ADJUSTING VALVE/GAUGE	48/6	802090-19359 -0
19360	PISTOL GRIP NYLON BLOW GUN	12/48	802090-19360 -6
19361	DOUBLE MALE CONNECTOR, 1/4IN NPT	192/12	802090-19361 -3
19365	1/4IN X 25FT POLYURETHANE AIR HOSE	20/5	802090-19365 -1
19366	1/4IN X 50FT POLYURETHANE AIR HOSE	2/10	802090-19366 -8
19367	1/4IN X 100FT POLYURETHANE AIR HOSE	2/10	802090-19367 -5
19368	1/4 X 25FT POLYURETHANE RECOIL AIR HOSE	40/1	802090-19368 -2
19369	1/4IN SWIVEL CONNECTOR	144/12	802090-19369 -9
19371	3/8IN X 50FT PVC AIR HOSE, 1/4IN NPT	6/1	802090-19371 -2
19377	3/8 HYBRID AIR HOSE, 50FT, 1/4IN NPT	6/1	802090-19377 -4
19378	INLINE BLOW GUN	48/8	802090-19378 -1
19380	POCKET BLOW GUN	80/10	802090-19380 -4
19385	BLOW GUN SHIELD	72/12	802090-19385 -9
19387	20IN AIR BLOW GUN	48/12	802090-19387 -3
19388	30IN AIR BLOW GUN	48/12	802090-19388 -0
19389	40IN AIR BLOW GUN	48/12	802090-19389 -7
19390	AIR DRYER GUN	20/1	802090-19390 -3
19395	AIR DRYER STAND AND HOSE	4/1	802090-19395 -8
19418	SIPHON FEED PRODUCTION SPRAY GUN	10/1	802090-19418 -4
19419	SPOT SPRAY NON-AEROSOL SPRAYER	1/20	802090-19419 -1
19420	SPOT SPRAY REBUILD KIT	50/25	802090-19420 -7
19421	TWINPACK SPOT SPRAYER SET	10/1	802090-19421 -4
19551	DUAL ACTION GRAVITY FEED AIRBRUSH	20/1	802090-19551 -8

PART NUMBER LISTING

PART NO.	DESCRIPTION	MASTER / INNER	UPC - CHECK DIGIT
19552	REPLACEMENT HOSE FOR 19551	1/1	802090-19552
19614	1.4MM WATERBORNE READY HVLP SPRAY GUN	10/1	802090-19614 -0
19614-14	1.4MM NEEDLE & NOZZLE SET	1/1	
19699	19PC AIR TOOL KIT	5/1	802090-19699 -7
19701	20PC DIE GRINDER KIT	5/1	802090-19701 -7
19703	CUT OFF TOOL	5/1	809020-19703 -1
19704	DIE GRINDER	20/1	802090-19704 -8
19706	1/2IN IMPACT WRENCH	5/1	809020-19706 -2
19707	AIR RATCHET	20/1	802090-19707 -9
19709	AIR HAMMER	5/1	802090-19709 -3
19800	3PC DUAL SET UP HVLP SPRAY GUN KIT	5/1	802090-19800 -7
19900	600ML PLASTIC CUP & LID	24/6	802090-19900 -4
19902	2PC PLASTIC LID FOR	48/6	802090-19902 -8
19903	REPLACEMENT CUP & LID	24/6	802090-19903 -5
19905	600ML PAINT MIXING CUP	10/1	802090-19905 -9
19906	ALUMINUM PAINT CUP AND PLASTIC LID	24/6	802090-19906 -6
19907	PAINT CUP REPLACEMENT LID	24/6	802090-19907 -3
19908	SPRAY GUN REBUILD KIT FOR 19000 SERIES	144/12	802090-19908 -0
19909	SPRAY GUN REBUILD KIT FOR 19100 SERIES	144/12	802090-19909 -7
19910	SPRAY GUN REBUILD KIT FOR TOUCH UP GUN	144/12	802090-19910 -3
19911	5PC IN-LINE PAINT FILTER	144/12	802090-19911 -0
19990	AIR SPRAY GUN HOLDER	10/5	802090-19990 -5
19991	SPRAY GUN HOLDER, MAGNETIC	24/6	802090-19991 -2

HARDWARE



ASSORTMENTS

A wide variety of assortment kits including:

- Nuts & Bolts
- Screws & Rivets
- Clips & Cotter Pins
- O-Rings and many more!
- Nylon Locknuts
- Washers
- Fuses

TEKZ



475pc Stainless Steel Metric Nut & Bolt Assortment

#45248

- Contains:
- | | | | |
|----------------------|--------|-----------------|--------|
| M4x16 Machine Screws | 20 PCS | M4 Flat Washers | 50 PCS |
| M4x25 Machine Screws | 20 PCS | M5 Flat Washers | 50 PCS |
| M5x20 Machine Screws | 20 PCS | M6 Flat Washers | 25 PCS |
| M5x25 Machine Screws | 20 PCS | M4 Hex Nuts | 50 PCS |
| M6x20 Machine Screws | 20 PCS | M5 Hex Nuts | 50 PCS |
| M4 Lock Washers | 50 PCS | M6 Hex Nuts | 25 PCS |
| M5 Lock Washers | 50 PCS | | |
| M6 Lock Washers | 25 PCS | | |
- Stainless Steel
- Re-sealable plastic case

Master Qty: 24 - Case Qty: 6
UPC: 8-02090-45248-2

475pc Metric Nut & Bolt Assortment

#45250

- Contains:
- | | | | |
|----------------------|--------|-----------------|--------|
| M4x16 Machine Screws | 20 PCS | #4 Flat Washers | 50 PCS |
| M4x25 Machine Screws | 20 PCS | #5 Flat Washers | 50 PCS |
| M5x20 Machine Screws | 20 PCS | #6 Flat Washers | 25 PCS |
| M5x25 Machine Screws | 20 PCS | M4 Hex Nuts | 50 PCS |
| M6x20 Machine Screws | 20 PCS | M5 Hex Nuts | 50 PCS |
| #4 Lock Washers | 50 PCS | M6 Hex Nuts | 25 PCS |
| #5 Lock Washers | 50 PCS | | |
| #6 Lock Washers | 25 PCS | | |
- Convenient re-sealable plastic case

Master Qty: 24 - Case Qty: 6
UPC: 8-02090-45250-5



300pc Metric Nut Assortment

#45300

- Contains:
- | | |
|------------|--------|
| M3 x 0.5 | 80 PCS |
| M4 x 0.7 | 70 PCS |
| M5 x 0.8 | 70 PCS |
| M6 x 1.0 | 50 PCS |
| M8 x 1.25 | 20 PCS |
| M10 x 1.50 | 10 PCS |

- Stainless Steel
- Convenient re-sealable plastic case
- Master Qty: 24 - Case Qty: 6
UPC: 8-02090-45300-7



106pc Hex Cap Screw Assortment

#45306

- Contains:
- | | | | |
|------------------|--------|---------------------|-------|
| #8 x 32 x 1/2" | 25 PCS | 5/16" x 18 x 1" | 5 PCS |
| #10 x 24 x 1/2" | 25 PCS | 5/16" x 18 x 1-1/2" | 5 PCS |
| #10 x 24 x 1" | 20 PCS | 3/8" x 16 x 1" | 3 PCS |
| 1/4" x 20 x 1/2" | 10 PCS | 3/8" x 16 x 1-1/2" | 3 PCS |
| 1/4" x 20 x 1" | 10 PCS | | |
- Convenient re-sealable plastic case

Master Qty: 24 - Case Qty: 6
UPC: 8-02090-45306-9



240pc Black USS Nut & Bolt Assortment

#45330

- Contains
- | | | | |
|----------------|--------|------------------|--------|
| Bolts: | | Hex Nuts: | |
| #8 x 1/2" | 10 PCS | #8 | 20 PCS |
| #8 x 3/4" | 10 PCS | #10 | 20 PCS |
| #10 x 5/8" | 10 PCS | 1/4" | 20 PCS |
| #10 x 1" | 10 PCS | 5/16" | 10 PCS |
| 1/4" x 3/4" | 10 PCS | 3/8" | 10 PCS |
| 1/4" x 1-1/4" | 10 PCS | Washers: | |
| 5/16" x 1" | 5 PCS | #8 | 20 PCS |
| 5/16" x 1-1/2" | 5 PCS | #10 | 20 PCS |
| 3/8" x 5/8" | 5 PCS | 1/4" | 20 PCS |
| 3/8" x 1-1/2" | 5 PCS | 5/16" | 10 PCS |
| | | 3/8" | 10 PCS |
- Black Oxide Finish
- Convenient re-sealable plastic case

Master Qty: 24 - Case Qty: 6
UPC: 8-02090-45330-4



240pc Black Metric Nut & Bolt Assortment

#45331

- Contains
- | | | | |
|---------------|--------|------------------|--------|
| Bolts: | | Hex Nuts: | |
| M4 x 12M | 10 PCS | M4 | 20 PCS |
| M4 x 20M | 10 PCS | M5 | 20 PCS |
| M5 x 16M | 10 PCS | M6 | 20 PCS |
| M5 x 25M | 10 PCS | M8 | 10 PCS |
| M6 x 20M | 10 PCS | M10 | 10 PCS |
| M6 x 30M | 10 PCS | Washers: | |
| M8 x 25M | 5 PCS | M4 | 20 PCS |
| M8 x 40M | 5 PCS | M5 | 20 PCS |
| M10 x 16M | 5 PCS | M6 | 20 PCS |
| M10 x 40M | 5 PCS | M8 | 10 PCS |
| | | M10 | 10 PCS |
- Black Oxide Finish
- Convenient re-sealable plastic case

Master Qty: 24 - Case Qty: 6
UPC: 8-02090-45331-1



240pc Zinc USS Nut & Bolt Assortment

#45333

- Contains
- | | | | | | |
|------------------|--------|-----------------|--------|----------------|--------|
| Hex Nuts: | | Washers: | | Bolts: | |
| #8 | 20 PCS | #8 | 20 PCS | #8 x 1/2" | 10 PCS |
| #10 | 20 PCS | #10 | 20 PCS | #8 x 3/4" | 10 PCS |
| 1/4" | 20 PCS | 1/4" | 20 PCS | #10 x 5/8" | 10 PCS |
| 5/16" | 10 PCS | 5/16" | 10 PCS | #10 x 1" | 10 PCS |
| 3/8" | 10 PCS | 3/8" | 10 PCS | 1/4" x 3/4" | 10 PCS |
| | | | | 1/4" x 1-1/4" | 10 PCS |
| | | | | 5/16" x 1" | 5 PCS |
| | | | | 5/16" x 1-1/2" | 5 PCS |
| | | | | 3/8" x 5/8" | 5 PCS |
| | | | | 3/8" x 1-1/2" | 5 PCS |
- Zinc Oxide Finish
- Convenient re-sealable plastic case

Master Qty: 24 - Case Qty: 6
UPC: 8-02090-45333-5



240pc Zinc Metric Nut & Bolt Assortment

#45334

- Contains
- | | | | | | |
|---------------|--------|------------------|--------|-----------------|--------|
| Bolts: | | Hex Nuts: | | Washers: | |
| M4 x 12M | 10 PCS | M4 | 20 PCS | M4 | 20 PCS |
| M4 x 20M | 10 PCS | M5 | 20 PCS | M5 | 20 PCS |
| M5 x 16M | 10 PCS | M6 | 20 PCS | M6 | 20 PCS |
| M5 x 25M | 10 PCS | M8 | 10 PCS | M8 | 10 PCS |
| M6 x 20M | 10 PCS | M10 | 10 PCS | M10 | 10 PCS |
| M6 x 30M | 10 PCS | | | | |
| M8 x 25M | 5 PCS | | | | |
| M8 x 40M | 5 PCS | | | | |
| M10 x 16M | 5 PCS | | | | |
| M10 x 40M | 5 PCS | | | | |
- Zinc Oxide Finish
- Convenient re-sealable plastic case

Master Qty: 24 - Case Qty: 6
UPC: 8-02090-45334-2





150pc Nylon Locknut Assortment

- #45223**
- Contains:
 - #10 x 24 25 PCS
 - 1/4" x 20 35 PCS
 - 1/4" x 28 25 PCS
 - 5/16" x 18 30 PCS
 - 3/8" x 16 25 PCS
 - 1/2" x 13 10 PCS
 - Nylon inserts prevent loosening
 - Convenient re-sealable plastic case
 - Master Qty: 24 - Case Qty: 6
 - UPC: 8-02090-45223-9

100pc USS (UNC) Nylon Locknut Assortment

- #45233**
- Contains:
 - #10 x 24 25 PCS
 - 1/4" x 20 25 PCS
 - 5/16" x 18 20 PCS
 - 3/8" x 16 20 PCS
 - 7/16" x 14 5 PCS
 - 1/2" x 13 5 PCS
 - Nylon inserts prevent loosening
 - Convenient re-sealable plastic case
 - Master Qty: 24 - Case Qty: 6
 - UPC: 8-02090-45233-8



100pc SAE (UNF) Nylon Locknut Assortment

- #45242**
- Contains:
 - #10 x 32 25 PCS
 - 1/4" x 28 25 PCS
 - 5/16" x 24 20 PCS
 - 3/8" x 24 20 PCS
 - 7/16" x 20 5 PCS
 - 1/2" x 20 5 PCS
 - Nylon inserts prevent loosening
 - Convenient re-sealable plastic case
 - Master Qty: 24 - Case Qty: 6
 - UPC: 8-02090-45242-0



100pc Metric Nylon Locknut Assortment

- #45243**
- Contains:
 - M4 25 PCS
 - M5 25 PCS
 - M6 20 PCS
 - M8 15 PCS
 - M10 10 PCS
 - M12 5 PCS
 - Nylon inserts prevent loosening
 - Convenient re-sealable plastic case
 - Master Qty: 24 - Case Qty: 6
 - UPC: 8-02090-45243-7



500pc Aluminum Rivet Assortment

- #45228**
- Contains:
 - 1/8" x 1/4" 120 PCS
 - 1/8" x 5/16" 120 PCS
 - 1/8" x 3/8" 120 PCS
 - 3/16" x 5/16" 70 PCS
 - 3/16" x 3/8" 70 PCS
 - Rustproof Aluminum Rivet Body
 - Steel Mandrel
 - Convenient re-sealable plastic case
 - Master Qty: 24 - Case Qty: 6
 - UPC: 8-02090-45228-4



200pc Hex Head Drill Screw Assortment

- #45220**
- Contains:
 - #8 x 1/2" 30 PCS
 - #8 x 5/8" 30 PCS
 - #8 x 3/4" 30 PCS
 - #8 x 1" 30 PCS
 - #10 x 1/2" 20 PCS
 - #10 x 5/8" 20 PCS
 - #10 x 3/4" 20 PCS
 - #10 x 1" 20 PCS
 - Convenient re-sealable plastic case
 - Master Qty: 24 - Case Qty: 6
 - UPC: 8-02090-45220-8



347pc SAE Screw Assortment

- #45221**
- Contains:
 - #6 x 1/2" Sheet Metal Screws 26 PCS
 - #6 x 3/4" Sheet Metal Screws 32 PCS
 - #10 x 1" Sheet Metal Screws 13 PCS
 - #4 x 1/2" Wood Screws 43 PCS
 - #6 x 3/4" Wood Screws 32 PCS
 - #8 x 1" Wood Screws 10 PCS
 - #10 Flat Washer 59 PCS
 - 1/4" Flat Washer 19 PCS
 - #10 x 3/4" Machine Screws 10 PCS
 - #10 x 1" Machine Screws 24 PCS
 - 1/4" x 3/4" Machine Screws 19 PCS
 - #10-24 Hex Nuts 49 PCS
 - 1/4"-20 Hex Nuts 11 PCS
 - Convenient re-sealable plastic case
 - Master Qty: 24 - Case Qty: 6
 - UPC: 8-02090-45221-5



347pc Metric Screw Assortment

- #45222**
- Contains:
 - #6 x 1/2" Sheet Metal Screws 32 PCS
 - #6 x 3/4" Sheet Metal Screws 26 PCS
 - #10 x 1" Sheet Metal Screws 13 PCS
 - #4 x 1/2" Wood Screws 43 PCS
 - #6 x 3/4" Wood Screws 32 PCS
 - #8 x 1" Wood Screws 10 PCS
 - M5 Flat Washers 59 PCS
 - M6 Flat Washers 19 PCS
 - #6 x 3/4" Machine Screws 10 PCS
 - #10 x 3/4" Machine Screws 24 PCS
 - #10 x 1" Machine Screws 19 PCS
 - M5 Hex Nuts 49 PCS
 - M6 Hex Nuts 11 PCS
 - Convenient re-sealable plastic case
 - Master Qty: 24 - Case Qty: 6
 - UPC: 8-02090-45222-2





240pc Self-Tapping Wood and Metal Screw Assortment

#45234

- Contains:
- | | | | |
|----------------|--------|-----------------|--------|
| #4 x 1/2" Wood | 20 PCS | #6 x 1/2" Metal | 20 PCS |
| #6 x 1/2" Wood | 20 PCS | #6 x 3/4" Metal | 20 PCS |
| #6 x 5/8" Wood | 20 PCS | #8 x 1/2" Metal | 20 PCS |
| #6 x 3/4" Wood | 20 PCS | #8 x 5/8" Metal | 20 PCS |
| #8 x 5/8" Wood | 20 PCS | #8 x 3/4" Metal | 20 PCS |
| #8 x 1" Wood | 20 PCS | #10 x 1" Metal | 20 PCS |

- Convenient re-sealable plastic case
 Master Qty: 24 - Case Qty: 6
 UPC: 8-02090-45234-5

160pc SAE Hex Head Set Screw Assortment

#45235

- Contains:
 USS Thread

- | | |
|-------------------|--------|
| 1/4" x 1/4" - 20 | 20 PCS |
| 1/4" x 3/8" - 20 | 10 PCS |
| 5/16" x 3/8" - 18 | 20 PCS |
| 5/16" x 1/2" - 18 | 10 PCS |
| 3/8" x 3/8" - 16 | 10 PCS |
| 3/8" x 1/2" - 18 | 10 PCS |

SAE Thread

- | | |
|--------------------|--------|
| 1/8" x 3/16" - 40 | 15 PCS |
| 3/16" x 1/4" - 24 | 10 PCS |
| 5/32" x 3/16" - 32 | 15 PCS |
| 1/4" x 1/4" - 28 | 15 PCS |
| 5/16" x 3/8" - 24 | 15 PCS |
| 3/8" x 3/8" - 24 | 10 PCS |

- Convenient re-sealable plastic case

Master Qty: 24 - Case Qty: 6
 UPC: 8-02090-45235-2



160pc Metric Hex Head Set Screw Assortment

#45251

- Contains:

- | | | | |
|---------------|--------|--------------|--------|
| 3mm x 5mm | 15 PCS | 8mm x 10mm | 20 PCS |
| 4mm x 5mm | 15 PCS | 8mm x 10mmF | 15 PCS |
| 5mm x 6mm | 10 PCS | 8mm x 12mm | 10 PCS |
| 6mm x 6mm | 20 PCS | 10mm x 10mm | 10 PCS |
| 6mm x 6mm (F) | 15 PCS | 10mm x 10mmF | 10 PCS |
| 6mm x 10mm | 10 PCS | 10mm x 12mm | 10 PCS |

- Convenient re-sealable plastic case

Master Qty: 24 - Case Qty: 6
 UPC: 8-02090-45251-2



METRIC

350pc Lock, Spring & Star Washer Assortment

#45216

- Contains:

- | | | | |
|-------------------|--------|-------------------|--------|
| #6 Flat Washer | 50 PCS | #6 Lock washer | 50 PCS |
| #8 Flat Washer | 40 PCS | #8 Lock Washer | 40 PCS |
| #10 Flat Washer | 30 PCS | #10 Lock Washer | 30 PCS |
| 1/4" Flat Washer | 25 PCS | 1/4" Lock Washer | 25 PCS |
| 5/16" Flat Washer | 15 PCS | 5/16" Lock Washer | 15 PCS |
| 3/8" Flat Washer | 15 PCS | 3/8" Lock washer | 15 PCS |

- Convenient re-sealable plastic case

Master Qty: 24 - Case Qty: 6
 UPC: 8-02090-45216-1



110pc Copper Washer Assortment

#45217

- Contains:

- | | |
|--------------|--------|
| 1/4" Washer | 30 PCS |
| 5/16" Washer | 25 PCS |
| 3/8" Washer | 20 PCS |
| 7/16" Washer | 15 PCS |
| 1/2" Washer | 10 PCS |
| 5/8" Washer | 10 PCS |

- Convenient re-sealable plastic case

Master Qty: 24 - Case Qty: 6
 UPC: 8-02090-45217-8



720pc Lock, Spring & Star Washer Assortment

#45218

- Contains:

- | | |
|-------|---------------------|
| #6 | 50 PCS (Each Style) |
| #8 | 50 PCS (Each Style) |
| #10 | 50 PCS (Each Style) |
| 1/4" | 40 PCS (Each Style) |
| 5/16" | 30 PCS (Each Style) |
| 3/8" | 20 PCS (Each Style) |

- Convenient re-sealable plastic case

Master Qty: 24 - Case Qty: 6
 UPC: 8-02090-45218-5



106pc Metric Socket Head Screw Assortment

#45307

- Contains:

- | |
|--------------------------|
| (25) M4 x 12 |
| (20) M5 x 25 |
| (10ea) M6 x 12, M6 x 25 |
| (5ea) M8 x 25, M8 x 40 |
| (3ea) M10 x 25, M10 x 40 |
- Convenient re-sealable plastic case

Master Qty: 24 - Case Qty: 6
 UPC: 8-02090-45307-6



1000pc Cotter Pin Assortment

#45204

- Contains:
- 1/16" x 1" 380 PCS 1/8" x 1-1/4" 115 PCS
- 3/32" x 1" 240 PCS 1/8" x 2" 75 PCS
- 3/32" x 1-1/2" 140 PCS 5/32" x 2-1/2" 50 PCS

- Convenient re-sealable plastic case

Master Qty: 24 - Case Qty: 6
UPC: 8-02090-45204-8



555pc Cotter Pin Assortment

#45205

- Contains:
- 1/16" x 1" 150 PCS 1/8" x 1-1/4" 75 PCS
- 3/32" x 1" 150 PCS 1/8" x 2" 50 PCS
- 3/32" x 1-1/2" 100 PCS 5/32" x 2-1/2" 30 PCS

- Convenient re-sealable plastic case

Master Qty: 24 - Case Qty: 6
UPC: 8-02090-45205-5



555pc Stainless Cotter Pin Assortment

#45245

- Contains:
- 1/16" x 1" 150 PCS
- 3/32" x 1" 150 PCS
- 3/32" x 1-1/2" 100 PCS
- 1/8" x 1-1/4" 75 PCS
- 1/8" x 2" 50 PCS
- 5/32" x 2-1/2" 30 PCS

- Stainless Steel

- Convenient re-sealable plastic case

Master Qty: 24 - Case Qty: 6
UPC: 8-02090-45245-1



144pc Large Cotter Pin Assortment

#45206

- Contains:
- 1/8" x 2" 50 PCS 1/4" x 2" 20 PCS
- 5/32" x 2-1/2" 30 PCS 1/4" x 3" 16 PCS
- 3/16" x 3" 20 PCS 5/16" x 2-1/2" 8 PCS

- Convenient re-sealable plastic case

Master Qty: 24 - Case Qty: 6
UPC: 8-02090-45206-2



300pc E-Clip Assortment

#45208

- Contains:
- 1/16" 30 PCS 1/2" 40 PCS
- 1/8" 30 PCS 5/8" 20 PCS
- 3/16" 40 PCS 3/4" 20 PCS
- 1/4" 50 PCS 7/8" 20 PCS
- 3/8" 50 PCS

- Black Oxide Finish

- Convenient re-sealable plastic case

Master Qty: 24 - Case Qty: 6
UPC: 8-02090-45208-6



300pc Snap Ring Assortment

#45212

- Contains:
- INTERNAL
- EXTERNAL
- EXTERNAL cont.
- 3/16" 15 PCS 1/8" 20 PCS 5/8" 20 PCS
- 3/8" 20 PCS 5/32" 10 PCS 13/16" 15 PCS
- 7/16" 15 PCS 1/4" 25 PCS 1" 15 PCS
- 15/32" 15 PCS 5/16" 15 PCS 1-1/16" 15 PCS
- 3/4" 25 PCS 1/2" 25 PCS 1-1/8" 10 PCS
- 7/8" 20 PCS 9/16" 15 PCS 1-1/4" 5 PCS

- Convenient re-sealable plastic case

Master Qty: 24 - Case Qty: 6
UPC: 8-02090-45212-3



125pc Rubber Grommet Assortment

#45214

- Contains:
- Rubber Grommets
- Rubber Grommets cont.
- Rubber Plugs
- 1/8" x 1/4" 15 PCS 3/8" x 13/16" 3 PCS 9/32" 20 PCS
- 7/32" x 5/16" 10 PCS 7/16" x 3/4" 4 PCS 3/8" 20 PCS
- 9/32" x 1/2" 7 PCS 1/2" x 19/32" 3 PCS 1/2" 10 PCS
- 5/16" x 9/16" 3 PCS 5/8" x 31/32" 3 PCS 5/8" 5 PCS
- 3/8" x 15/32" 6 PCS 3/4" x 15/16" 2 PCS 3/4" 4 PCS
- 3/8" x 1/2" 5 PCS 7/8" 3 PCS
- 1" 2 PCS

- Convenient re-sealable plastic case

Master Qty: 24 - Case Qty: 6
UPC: 8-02090-45214-7



110pc Rubber Grommet Assortment

#45236

- Contains:
- 1/4" 25 PCS
- 5/16" 20 PCS
- 3/8" 20 PCS
- 7/16" 20 PCS
- 1/2" 10 PCS
- 5/8" 5 PCS
- 7/8" 5 PCS
- 1" 5 PCS

- Convenient re-sealable plastic case

Master Qty: 24 - Case Qty: 6
UPC: 8-02090-45236-9



550pc Nail Assortment

#45240

- Contains:

3/64" x 7/8" Brad Nails	100 PCS	3/32" x 1-1/4" Brad Nails	30 PCS
3/64" x 1" Brad Nails	80 PCS	3/32" x 2" Brad Nails	20 PCS
1/16" x 1-1/4" Brad Nails	80 PCS	3/64" x 1" Finishing Nails	80 PCS
1/16" x 1-1/2" Brad Nails	50 PCS	3/64" x 1-1/4" Finishing Nails	80 PCS
- Convenient re-sealable plastic case		3/32" x 1-1/2" Masonry Nails	30 PCS

Master Qty: 24 - Case Qty: 6
UPC: 8-02090-45240-6



80pc Vacuum Cap Assortment

#45252

- Contains:

3/16"	20 PCS	5/16"	5 PCS
5/32"	20 PCS	3/8"	5 PCS
7/32"	20 PCS	- Constructed of heat resistant	
1/4"	10 PCS	Buna-N Rubber	
		- Convenient re-sealable plastic case	

Master Qty: 24 - Case Qty: 6
UPC: 8-02090-45252-9



250pc Welding Stud Assortment

#45241

- Contains:

2" x 3/40"	250 PCS
------------	---------

- For use with a stud welder or stud gun
- Copper coated steel construction
- Convenient re-sealable plastic case

Master Qty: 24 - Case Qty: 6
UPC: 8-02090-45241-3



158pc Wire Nut Assortment

#45339

- Contains:

Gray: #22 to #16 AWG Wire (300v)	40 PCS
Blue: #22 to #14 AWG Wire (300v)	40 PCS
Orange: #22 to #14 AWG Wire (600v)	50 PCS
Yellow: #18 to #12 AWG Wire (600v)	18 PCS
Red: #18 to #10 AWG Wire (600v)	10 PCS

- UL Listed and CSA Certified
- Flame-Retardant Polypropylene Shell
- Reuseable
- Convenient re-sealable plastic case

Master Qty: 24 - Case Qty: 6
UPC: 8-02090-45339-7



151pc Hook and Eye Screw Assortment

#45340

- Contains:

Eye Screws	Hook Screws	
1-1/8"	1-5/8"	50 pcs
1-13/16"	2-1/2"	12 pcs
1-15/16"	3-3/8"	5 pcs

- Convenient re-sealable plastic case

Master Qty: 24 - Case Qty: 6
UPC: 8-02090-45340-3



70pc Grease Fitting Assortment

#45215

- Contains:

1/8" - 27 Straight	10 PCS	1/4" - 28 45°	5 PCS
1/8" - 27 45°	5 PCS	1/4" - 28 90°	5 PCS
1/8" - 27 90°	5 PCS	6mm x 1.0 Straight	10 PCS
1/4" - 28 Straight	20 PCS	8mm x 1.0 Straight	5 PCS
- Convenient re-sealable plastic case		10mm x 1.0 Straight	5 PCS

Master Qty: 24 - Case Qty: 6
UPC: 8-02090-45215-4



60pc Machinery Key Assortment

#45341

- Contains:

1/8" x 1/8" x 3/4"	4 PCS	1/4" x 1/4" x 1-1/2"	5 PCS
1/8" x 1/8" x 1"	4 PCS	5/16" x 5/16" x 1-1/4"	5 PCS
3/16" x 3/16" x 3/4"	5 PCS	5/16" x 5/16" x 1-1/2"	5 PCS
3/16" x 3/16" x 1"	5 PCS	3/8" x 3/8" x 1-1/4"	5 PCS
3/16" x 3/16" x 1-1/4"	5 PCS	3/8" x 3/8" x 1-1/2"	5 PCS
1/4" x 1/4" x 3/4"	5 PCS	1/2" x 1/2" x 1-1/2"	2 PCS
1/4" x 1/4" x 1-1/4"	5 PCS		

- Convenient re-sealable plastic case

Master Qty: 24 - Case Qty: 6
UPC: 8-02090-45341-0



120pc Roll Pin Assortment

#45342

- Contains:

5/32" x 5/8"	4 PCS	5/64" x 1/2"	4 PCS	1/8" x 1-1/4"	5 PCS
5/32" x 1"	4 PCS	5/64" x 1"	4 PCS	3/8" x 3/4"	2 PCS
5/32" x 1-1/2"	4 PCS	1/16" x 3/16"	4 PCS	3/8" x 1-1/2"	2 PCS
1/4" x 5/8"	4 PCS	1/16" x 3/4"	4 PCS	3/8" x 2"	2 PCS
1/4" x 1-1/4"	4 PCS	1/16" x 5/16"	4 PCS	7/32" x 5/8"	4 PCS
1/4" x 1-3/4"	4 PCS	3/32" x 5/8"	4 PCS	7/32" x 1-1/4"	4 PCS
5/16" x 3/4"	4 PCS	3/32" x 1-1/4"	4 PCS	7/32" x 1-3/4"	4 PCS
5/16" x 1-1/2"	4 PCS	3/32" x 1-3/4"	4 PCS	3/16" x 5/8"	5 PCS
5/16" x 2"	4 PCS	1/8" x 5/8"	5 PCS	3/16" x 1"	5 PCS
5/64" x 1/4"	4 PCS	1/8" x 1"	5 PCS	3/16" x 1-1/4"	5 PCS

- Convenient re-sealable plastic case

Master Qty: 24 - Case Qty: 6
UPC: 8-02090-45342-7



295pc Shop Assortment

#45343

- Contains:

3/8" Retaining Ring	12 PCS	5/32 x 1" Roll Pin	12 PCS
1/2" Retaining Ring	12 PCS	3/16 x 5/8" Roll Pin	12 PCS
5/8" Retaining Ring	12 PCS	3/16 x 1" Roll Pin	12 PCS
3/4" Retaining Ring	12 PCS	3/32 x 3/8" Woodruff Key	25 PCS
1/4" E-Clip	20 PCS	3/32 x 1/2" Woodruff Key	25 PCS
3/8" E-Clip	20 PCS	1/8 x 1/2" Woodruff Key	25 PCS
1/8 x 5/8" Roll Pin	12 PCS	1/8 x 5/8" Woodruff Key	25 PCS
1/8 x 1" Roll Pin	12 PCS	5/32 x 5/8" Woodruff Key	25 PCS
5/32 x 5/8" Roll Pin	12 PCS	3/16 x 3/4" Woodruff Key	10 PCS

- Convenient re-sealable plastic case

Master Qty: 24 - Case Qty: 6
UPC: 8-02090-45343-4

34pc Hose Clamp Assortment

#45348

- Contains:

5/8" (16mm)	8 PCS	1" (25mm)	4 PCS
3/4" (19mm)	8 PCS	1-1/16" (27mm)	4 PCS
7/8" (22mm)	6 PCS	1-1/4" (32mm)	4 PCS

- Convenient re-sealable plastic case

Master Qty: 24 - Case Qty: 6
UPC: 8-02090-45348-9





150pc Hitch Pin Assortment

#45210

- Contains:
- 3/32" x 1-3/16" 42 PCS
- 5/64" x 1-5/16" 30 PCS
- 5/64" x 1-9/16" 25 PCS
- 7/64" x 1-5/8" 25 PCS
- 9/64" x 1-3/4" 20 PCS
- 5/32" x 2-15/16" 8 PCS

- Convenient re-sealable plastic case
Master Qty: 24 - Case Qty: 6
UPC: 8-02090-45210-9

20pc Clevis Pin Assortment

#45249

- Contains:
- 1/4" x 1-1/4" 1 PC 5/16" x 2-1/4" 2 PCS
- 1/4" x 1-1/2" 2 PCS 5/16" x 2-1/2" 2 PCS
- 1/4" x 2" 1 PC 5/16" x 3" 2 PCS
- 5/16" x 1" 1 PC 3/8" x 1" 1 PC
- 5/16" x 1-1/4" 1 PC 3/8" x 2" 2 PCS
- 5/16" x 1-1/2" 2 PCS 3/8" x 2-3/8" 1 PCS
- 5/16" x 2" 2 PCS

- Convenient re-sealable plastic case

Master Qty: 24 - Case Qty: 6
UPC: 8-02090-45249-9



71pc Clevis Pin Assortment

#45359

- Contains:
- Tiller Tine Pins**
- 5/16" x 2" 5 PCS
- 3/8" x 2" 18 PCS
- 7/16" x 2-1/2" 5 PCS
- 1/2" x 2" 3 PCS
- Hair Pins:**
- 5/64" x 1-5/16" 7 PCS
- 7/64" x 1-5/8" 20 PCS
- 7/64" x 2-5/16" 7 PCS
- 9/64" x 1-3/4" 6 PCS

- Convenient re-sealable plastic case

Master Qty: 24 - Case Qty: 6
UPC: 8-02090-45359-5

200pc Spring Assortment

#45200

- Contains:
- Compression Springs -**
- 7/32" x 11/16" 10 pcs
- 7/32" x 1-1/2" 10 pcs
- 9/32" x 1/2" 10 pcs
- 9/32" x 3/4" 10 pcs
- 1/4" x 13/32" 10 pcs
- 23/64" x 1-3/8" 8 pcs
- 3/8" x 5/8" 6 pcs
- 3/8" x 3/4" 12 pcs
- Small compression and extension springs
- Re-sealable plastic case
- Extension Springs -**
- 3/16" x 1-3/4" 8 pcs
- 5/32" x 3-1/8" 12 pcs
- 13/64" x 13/16" 10 pcs
- 7/32" x 1" 10 pcs
- 9/32" x 1-1/2" 10 pcs
- 9/32" x 2-13/16" 12 pcs
- 11/32" x 1-27/32" 12 pcs
- 11/32" x 1-7/16" 10 pcs
- 1/4" x 7/8" 10 pcs
- 5/16" x 1-1/8" 8 pcs
- 5/16" x 1-1/4" 10 pcs
- 5/16" x 1-3/4" 12 pcs

Master Qty: 24 - Case Qty: 6
UPC: 8-02090-45200-0



270pc HNBR O-Ring Assortment

#45201 Master Qty: 24 - Case Qty: 6 UPC: 8-02090-45201-7

- For R134A Air Conditioning systems
- Contains the following 18 most popular sizes
- 7/32" x 1/16" 20 pcs
- 1/4" x 1/16" 20 pcs
- 9/32" x 5/64" 20 pcs
- 5/16" x 1/16" 20 pcs
- 5/16" x 5/64" 20 pcs
- 5/16" x 5/64" 20 pcs
- 11/32" x 5/64" 20 pcs
- 3/8" x 5/64" 10 pcs
- 7/16" x 1/16" 15 pcs
- 7/16" x 5/64" 15 pcs
- 7/16" x 3/32" 15 pcs
- 1/2" x 5/64" 15 pcs
- 9/16" x 1/16" 10 pcs
- 9/16" x 3/32" 10 pcs
- 5/8" x 5/64" 10 pcs
- 11/16" x 1/16" 10 pcs
- 11/16" x 1/8" 10 pcs
- 11/16" x 5/64" 10 pcs



225pc SAE O-Ring Assortment

Master Qty: 24 - Case Qty: 6 UPC: 8-02090-45225-3 #45225

- Contains:
- 3/32" X 15/64" 10 PCS
- 1/8" X 1/4" 20 PCS
- 5/32" X 9/32" 20 PCS
- 3/16" X 5/16" 20 PCS
- 7/32" X 11/32" 15 PCS
- 1/4" X 3/8" 15 PCS
- 5/16" X 7/16" 15 PCS
- 3/8" X 1/2" 10 PCS
- 3/8" X 9/16" 10 PCS
- 7/16" X 5/8" 10 PCS
- 1/2" X 11/16" 10 PCS
- 9/16" X 3/4" 10 PCS
- 5/8" X 13/16" 10 PCS
- 11/16" X 7/8" 10 PCS
- 3/4" X 15/16" 10 PCS
- 1 1/8" 10 PCS
- 1 1/16" 10 PCS

- Convenient re-sealable plastic case

407pc SAE O-Ring Assortment

- Contains the following 32 most popular sizes #45202

Item Numbers	Nominal Sizes	Qty.	Item Numbers	Nominal Sizes	Qty.						
Loc. #	Size #	I.D.	O.D.	Thickness	Loc. #	Size #	I.D.	O.D.	Thickness		
R-01	006	1/8"	1/4"	1/16"	20	R-17	211	13/16"	1-1/16"	1/8"	10
R-02	008	3/16"	5/16"	1/16"	20	R-18	212	7/8"	1-1/8"	1/8"	10
R-03	010	1/4"	3/8"	1/16"	20	R-19	213	15/16"	1-3/16"	1/8"	10
R-04	011	5/16"	7/16"	1/16"	20	R-20	214	1"	1-1/4"	1/8"	10
R-05	012	3/8"	1/2"	1/16"	20	R-21	215	1-1/16"	1-5/16"	1/8"	10
R-06	014	1/2"	5/8"	1/16"	20	R-22	216	1-1/8"	1-3/8"	1/8"	10
R-07	110	3/8"	9/16"	3/32"	13	R-23	217	1-3/16"	1-7/16"	1/8"	10
R-08	111	7/16"	5/8"	3/32"	13	R-24	218	1-1/4"	1-1/2"	1/8"	10
R-09	112	1/2"	11/16"	3/32"	13	R-25	219	1-5/16"	1-9/16"	1/8"	10
R-10	113	9/16"	3/4"	3/32"	13	R-26	220	1-3/8"	1-5/8"	1/8"	10
R-11	114	5/8"	13/16"	3/32"	13	R-27	221	1-7/16"	1-11/16"	1/8"	10
R-12	115	11/16"	7/8"	3/32"	13	R-28	222	1-1/2"	1-3/4"	1/8"	10
R-13	116	3/4"	15/16"	3/32"	13	R-29	223	1-5/8"	1-7/8"	1/8"	10
R-14	117	13/16"	1"	3/32"	13	R-30	224	1-3/4"	2"	1/8"	10
R-15	118	7/8"	11/16"	3/32"	13	R-31	225	1-7/8"	2-1/8"	1/8"	10
R-16	210	3/4"	1"	1/8"	10	R-32	226	2"	2-1/4"	1/8"	10

- Constructed of Buna-N BG715 (Nitrile 70 Shore) Rubber
- Meets ASTM D-2000 SAE J200 Standards
- Convenient re-sealable plastic case

Master Qty: 24 - Case Qty: 6 **UPC: 8-02090-45202-4**

419pc Metric O-Ring Assortment

#45203 - Contains the following 32 most popular sizes

Item Numbers	Nominal Sizes	Qty	Item Numbers	Nominal Sizes	Qty		
Loc. #	I.D. MM	Thickness	Loc. #	I.D. MM	Thickness		
R-01	3.00	1.78	20	R-17	20.00	3.53	10
R-02	4.40	2.62	20	R-18	22.00	3.53	10
R-03	5.00	2.62	18	R-19	23.50	3.53	10
R-04	7.00	1.78	23	R-20	25.00	3.53	10
R-05	10.00	1.78	23	R-21	26.50	3.53	10
R-06	13.00	1.78	23	R-22	28.00	3.53	10
R-07	10.00	2.62	14	R-23	30.00	3.53	10
R-08	11.00	2.62	13	R-24	31.00	3.53	10
R-09	13.00	2.62	14	R-25	33.00	3.53	10
R-10	14.00	2.62	13	R-26	34.50	3.53	10
R-11	16.00	2.62	14	R-27	36.00	3.53	10
R-12	18.00	2.62	14	R-28	38.00	3.53	10
R-13	19.00	2.62	13	R-29	41.00	3.53	10
R-14	21.00	2.62	14	R-30	44.00	3.53	10
R-15	22.00	2.62	13	R-31	47.00	3.53	10
R-16	18.00	3.53	10	R-32	50.00	3.53	10

- Constructed of Buna-N BG715 (Nitrile 70 Shore) Rubber
- Meets ASTM D-2000 SAE J200 Standards
- Convenient re-sealable plastic case

Master Qty: 24 - Case Qty: 6
UPC: 8-02090-45203-1



Merchandising Options

All Hardware and Fuse Kits feature multiple options of merchandising styles.

Kits can be merchandized:

- Vertically....either being hung from a peg hook (perfect for wall and gondola displaying) or standing vertically on a shelf.
- Horizontally....either flat or on end

All Hardware and Fuse kits feature an itemized inner label, showing the items specifics and the piece count contained of each item in each kit.



Horizontally



Vertically



Inner label showing item specifics and piece count

96pc ATO Fuse Assortment

#45227



- Contains:

3A (Violet)	12 PCS	15A (Blue)	12 PCS
5A (Orange)	12 PCS	20A (Yellow)	12 PCS
7.5A (Brown)	12 PCS	25A (Clear)	12 PCS
10A (Red)	12 PCS	30A (Green)	12 PCS
- Zinc electrodes
- Convenient re-sealable plastic case

Master Qty: 20 - Case Qty: 5
UPC: 8-02090-45227-7

96pc Mini Fuse Assortment

#45229

- Contains:

15A (Blue)	12 PCS
3A (Violet)	12 PCS
5A (Orange)	12 PCS
7.5A (Brown)	12 PCS
10A (Red)	12 PCS
15A (Blue)	12 PCS
20A (Yellow)	12 PCS
25A (Clear)	12 PCS
30A (Green)	12 PCS
- Zinc electrodes
- Convenient re-sealable plastic case

Master Qty: 20 - Case Qty: 5
UPC: 8-02090-45229-1



88pc Master Auto Fuse Assortment

#45230

- | | |
|-------------------------|------------------------------|
| Blade Fuses
(5 Each) | Maxi Blade Fuses
(1 Each) |
| 3A (Violet) | 20A (Yellow) |
| 5A (Orange) | 30A (Green) |
| 7.5A (Brown) | 40A (Orange) |
| 10A (Red) | 50A (Red) |
| 15A (Blue) | 60A (Blue) |
| 20A (Yellow) | 70A (Tan) |
| 25A (Clear) | 80A (Clear) |
| 30A (Green) | 100A (Purple) |

Master Qty: 24 - Case Qty: 6
UPC: 8-02090-45230-7

24pc Maxi Fuse Assortment

#45232

- Contains:

20A (Yellow)	3 PCS	60A (Blue)	3 PCS
30A (Green)	3 PCS	70A (Tan)	3 PCS
40A (Orange)	3 PCS	80A (Clear)	3 PCS
50A (Red)	3 PCS	100A (Purple)	3 PCS
- Zinc electrodes
- Convenient re-sealable plastic case

Master Qty: 20 - Case Qty: 5
UPC: 8-02090-45232-1

