

PARTS INCLUDED

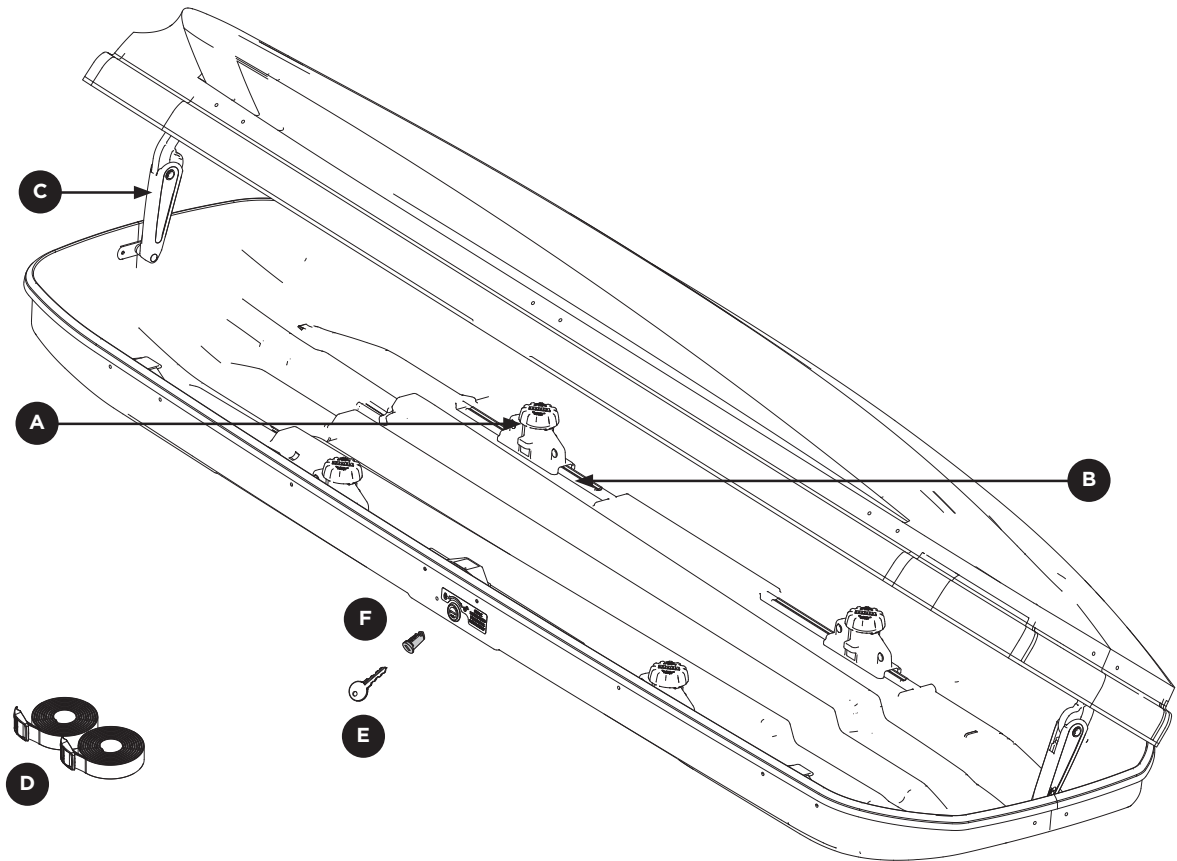

part	description	part number	qty.
A	Easy-Grip™ Mounting Hardware /	1401470000	4
B	Easy-Grip™ Sealing Strip /	1001071500	4
C	Lid Lifter /	14933	2
D	Tie Down Strap /	10169	2
E	Key /	—	2
F	Lock Cylinder /	—	1

1

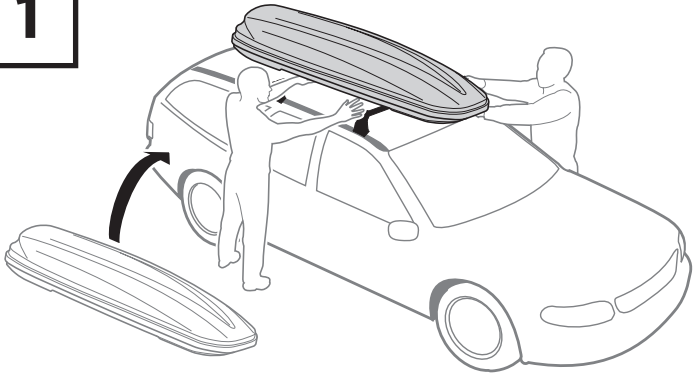

- With the help of another person place box on roof rack.

2



- Check rear hatch and front hood clearance.
- Check roof-mounted antenna clearance.

3

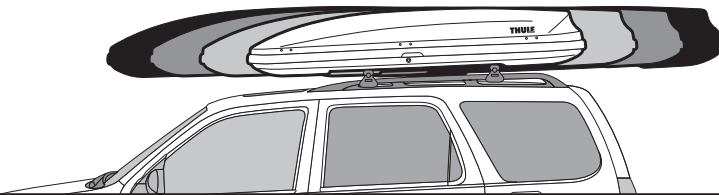

NOTE: Mount box towards the rear of the vehicle to minimize wind resistance.

- Slide box forward or backward to position rubber-lined mounting points over crossbars, and to eliminate any hood/hatch/antenna interference.

4

Minimum bar spread = 23 5/8" or 600mm.

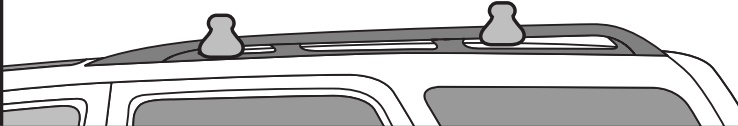

- If rack crossbars are adjustable, set to widest position which can be accommodated by vehicle and box's mounting points.

UNLOCKING/LOCKING THE BOX

5

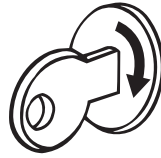
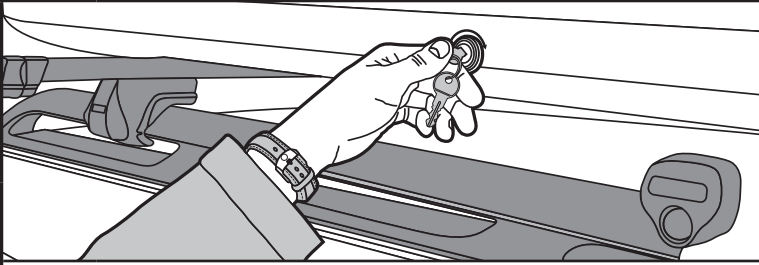

OPEN

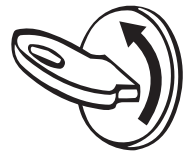

CLOSE

Unlocking: Insert the key and turn clockwise to the unlocked position. The key can only be removed when the box lid is closed and locked.
Locking: To close, press down on the lid at the front and rear of the box. Turn the key counterclockwise to lock. Remove key.

6

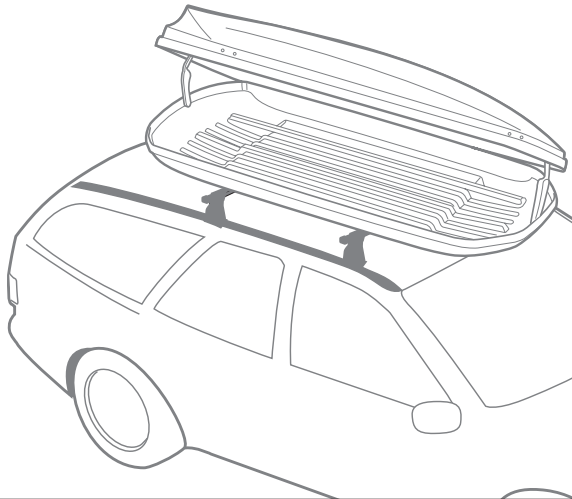
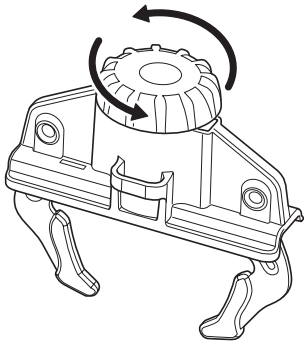

- Unlock cargo box and open.
- Remove Easy-Grip™ mounting hardware from packaging inside box. Turn knobs counter-clockwise until completely open.

7

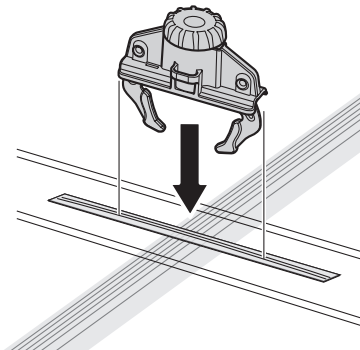
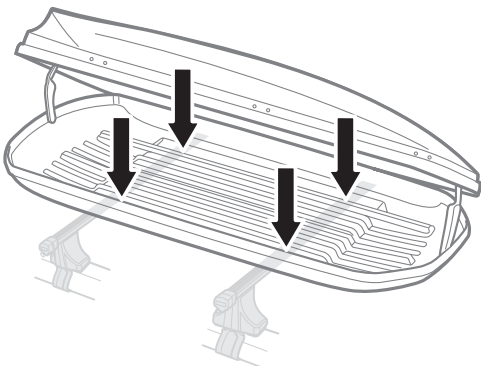

- Insert Easy-Grips™ into rubber-lined mounting slots in bottom of box and over vehicle crossbars.

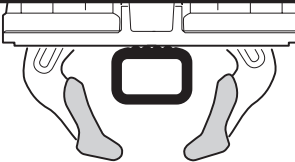
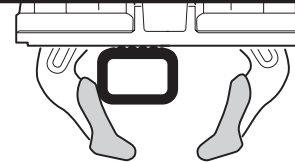
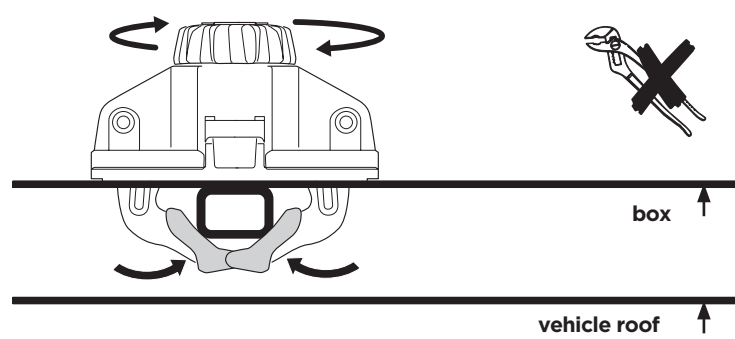
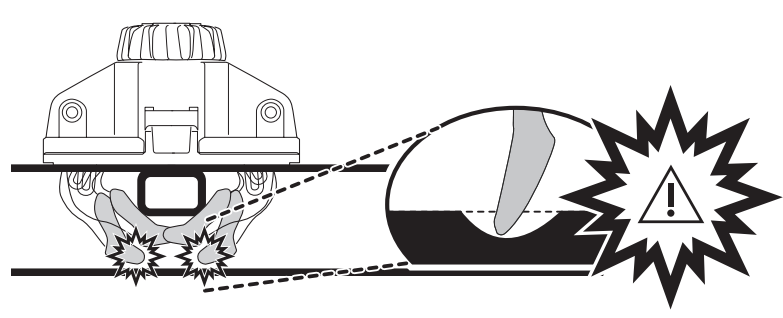
8			<ul style="list-style-type: none"> Center the Easy-Grips™ over the crossbars.
CORRECT		INCORRECT	
			<ul style="list-style-type: none"> Check to make sure all four Thule Easy-Grips™ are correctly positioned on the crossbars and tighten by turning in a clockwise direction. Tighten firmly! Check the tightness of each Easy-Grip™ once more to ensure a secure fit.
			<p>CAUTION: Avoid vehicle roof contact.</p>

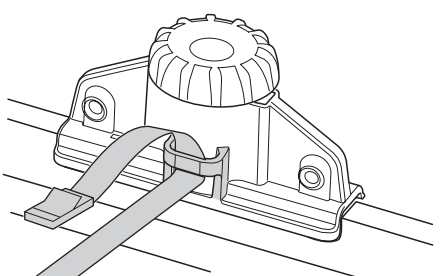
9		<ul style="list-style-type: none"> Secure loads to Easy-Grip™ with supplied load straps.
---	---	---

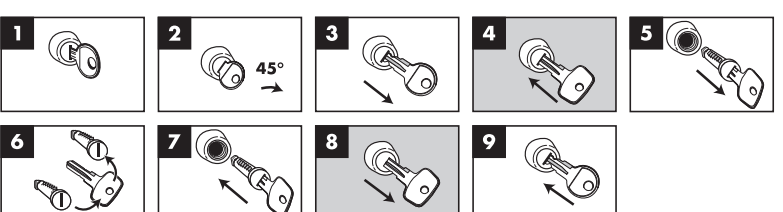
10	EXCHANGING LOCK CORES			
<ul style="list-style-type: none"> In order to change the existing lock core to a different lock core number, follow steps 1-9 below. 				
1	2	3	4	5
6	7	8	9	
				<p>NOTE: Key in #4 through #8 is a Master Key.</p>

11

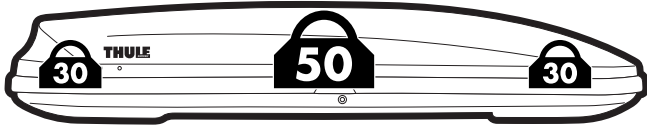

- Make sure that loads are evenly distributed inside the cargo box. Do not exceed the maximum permitted load of 110 lbs./50kg. for the box or the maximum permitted load for the roof as recommended by the vehicle manufacturer, as well of the maximum load of the load carrier.

12

MAINTENANCE

- The cargo box should be carefully cleaned and maintained, particularly in the winter months.
- For cleaning, use only water with a mild detergent which contains no additives (such as alcohol, chlorine or ammonia) as these could damage the surface of the cargo box.
- The locks should be lubricated with graphite or similar dry lubricant.
- Box should be protected from exposure to the elements during prolonged periods of storage.
- Box and fittings should be inspected periodically for damage.

13

CARGO AND USAGE WARNINGS

