



Thule XT Kit 3177

> Instructions

TOYOTA RAV4, 5-dr SUV, 19-

This kit is only for vehicles with fixpoint mounting.

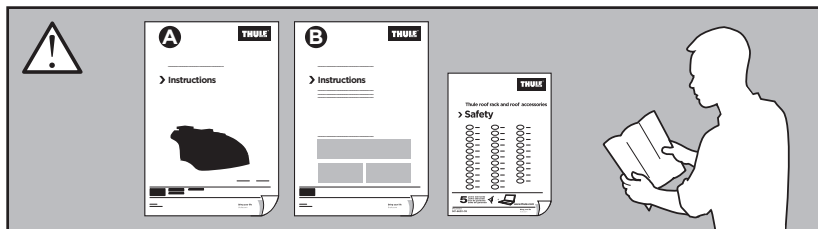

xx kg xx lbs	5 kg 11 lbs
+	
=	
Max. 75 kg	Max. 165 lbs

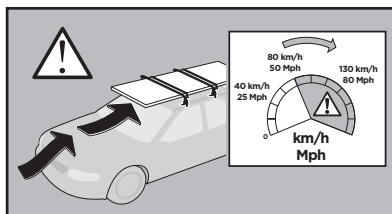

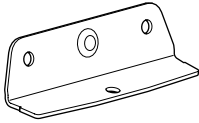

◀ 20 x4



50784

x4

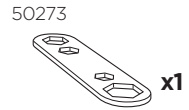

50273

x1

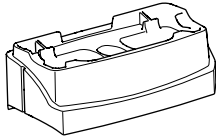

◀ 243 x2



31310

x4



B

THULE

> Instructions

x1

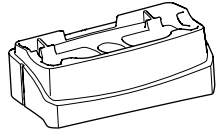

◀ 244 x1

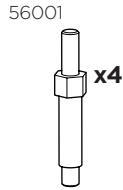

56001

x4

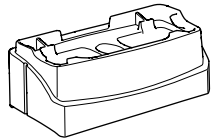

◀ 245 x1

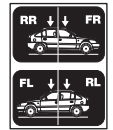

x1

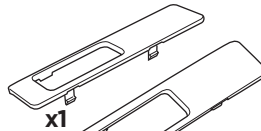

x1

x1

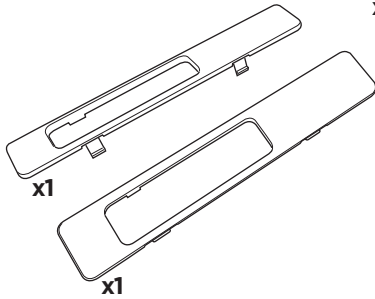

x1

x1

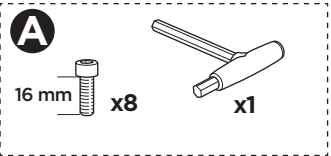

A

16 mm x8

x1

1

20

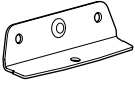

245



FL



FR



244

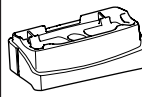

20

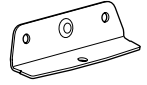

20

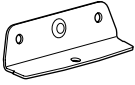

243

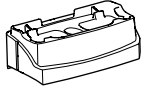

RL



RR



243

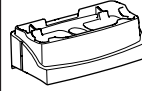

20

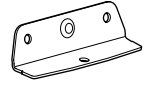

2

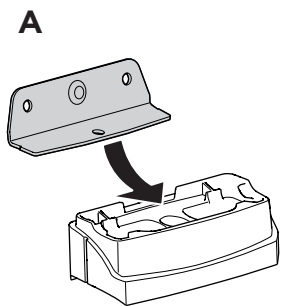

B

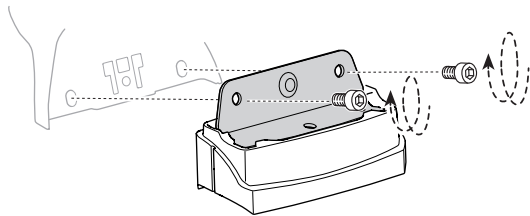
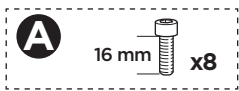

EN Only a few turns

3

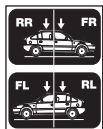

x1

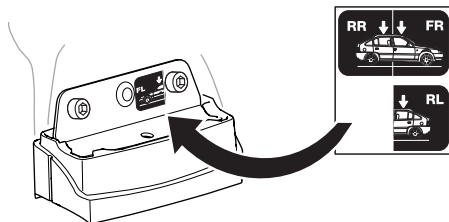

4

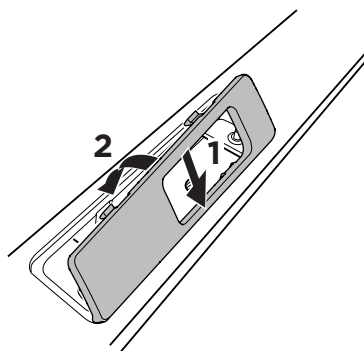
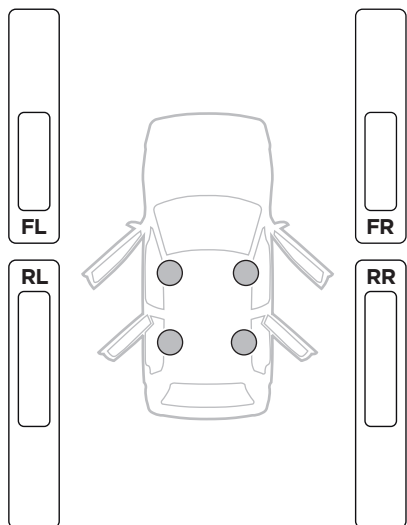
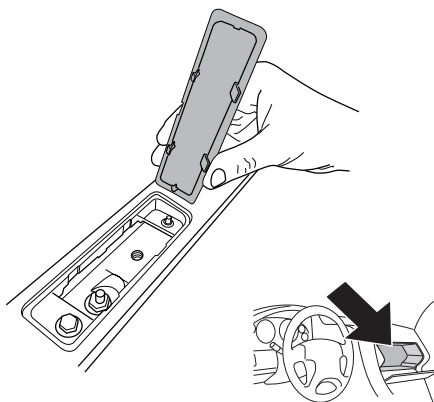
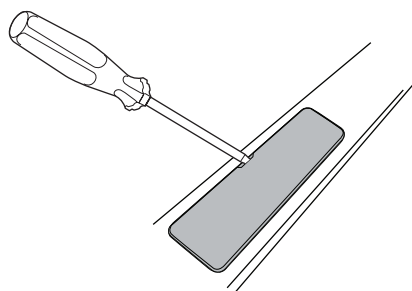
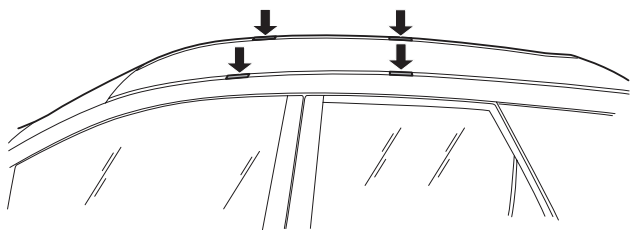

5

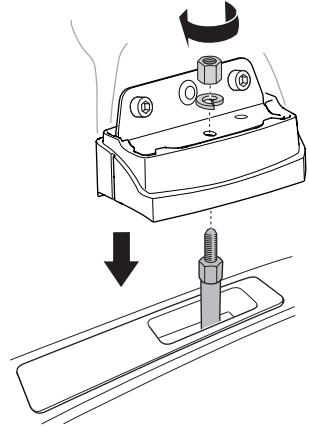
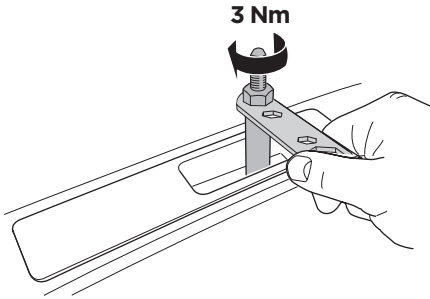
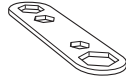

6

A

A

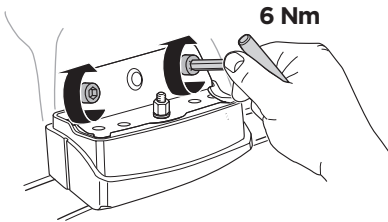
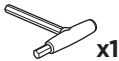

B

