

# ➤ Instructions

## Thule Force XT

6351 6352 6355 6356 6357 6358

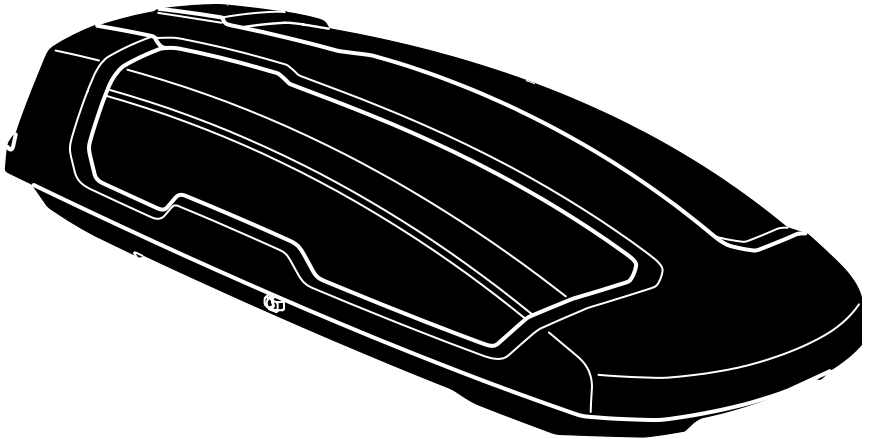

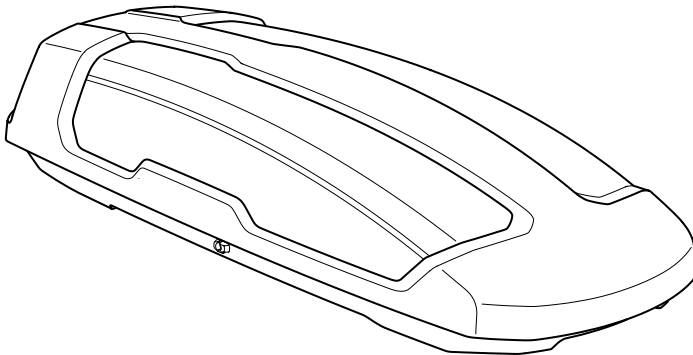
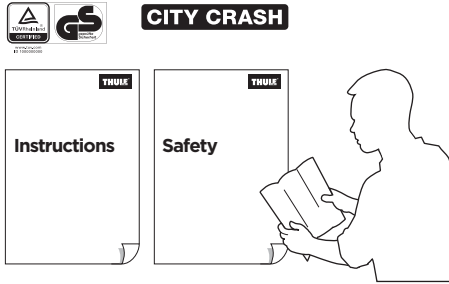

x1

- Thule WingBar Evo
- Thule WingBar
- Thule AeroBar
- Thule SlideBar
- Thule Squarebar



x1



x3



x2

**i**

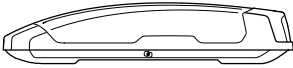
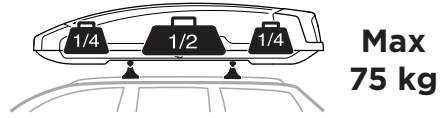

S	14,3 kg
M	16,4 kg
Alpine	19,4 kg
Sport	14,7 kg
L	18,7 kg
XL	21,3 kg

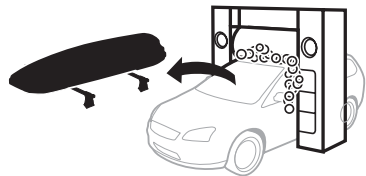
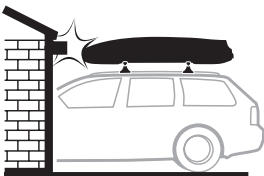
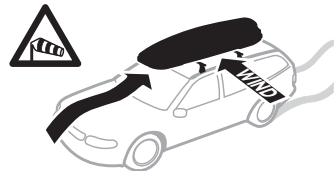
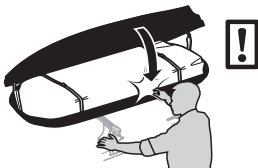
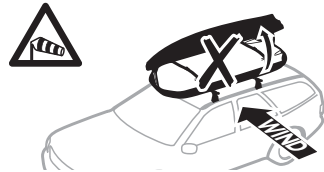
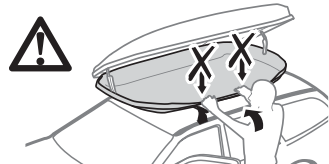
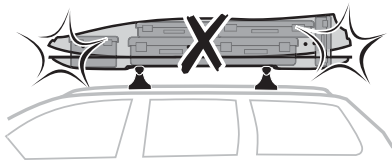
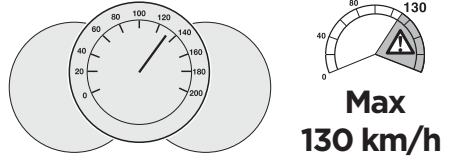

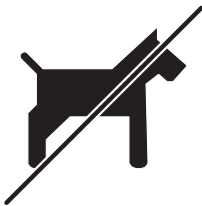
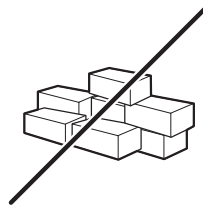
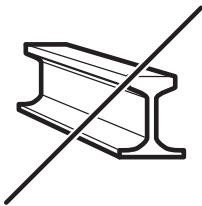
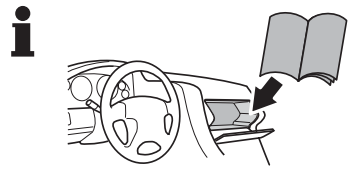
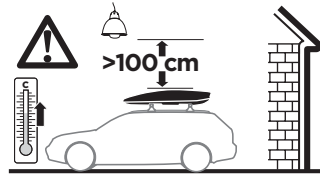
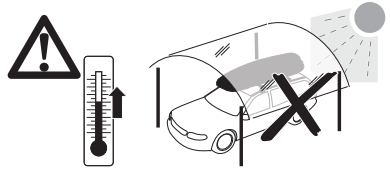
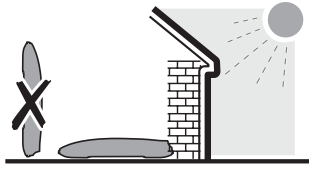

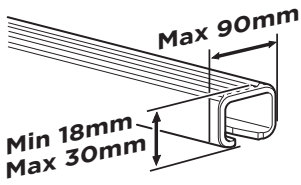
**i**

### Thule T-track Adapter

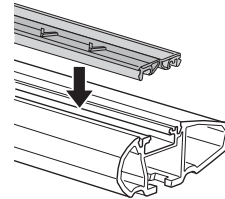
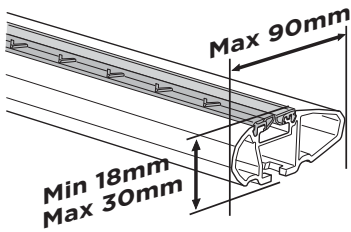
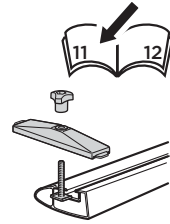
**696600**
**697600**

	D Min*	D Max*	W in*	W out*	H*	R Min*
S	557	845	786	896	388	971
M	557	932	710	820	424	1153
Alpine	557	909	590	700	394	1399
Sport	557	932	520	630	395	1227
L	557	918	730	840	428	1207
XL	557	911	750	860	410	1299

\*mm

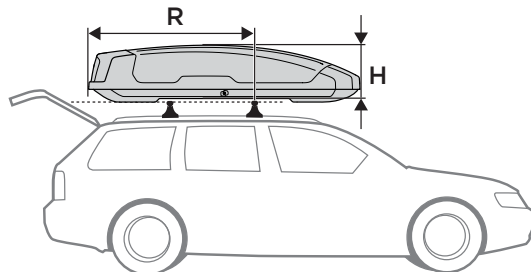
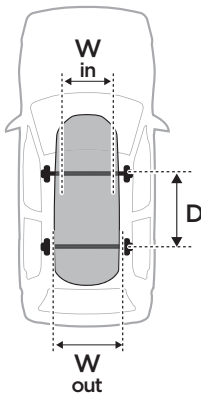

1

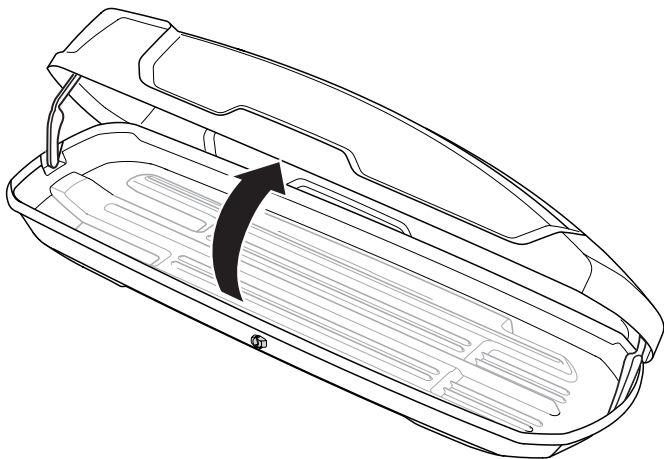
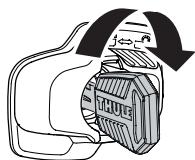

2

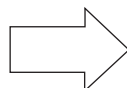
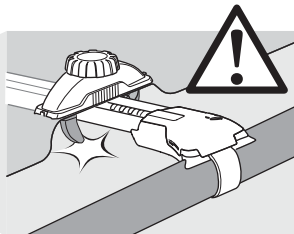
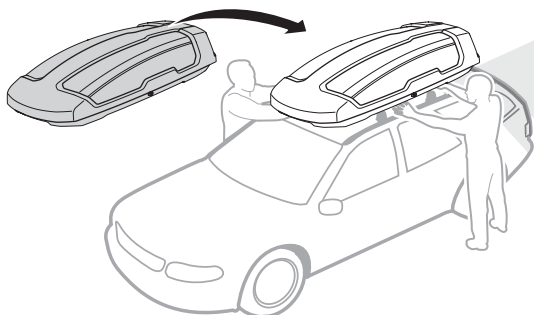
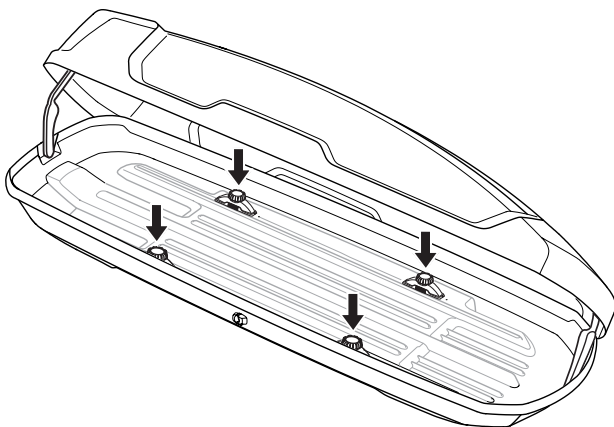
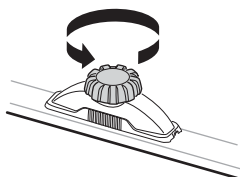

3

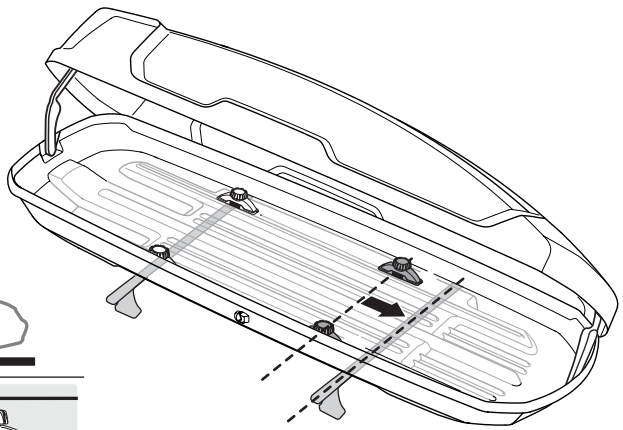
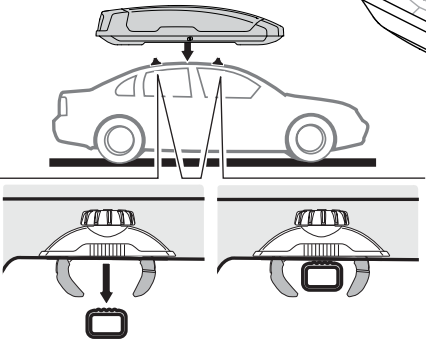
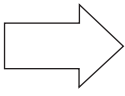

4

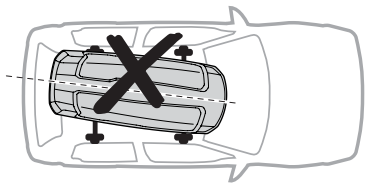
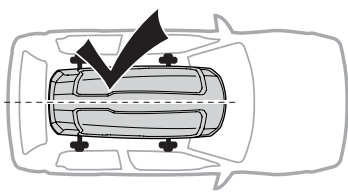
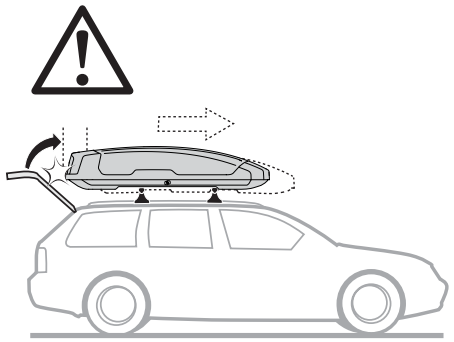
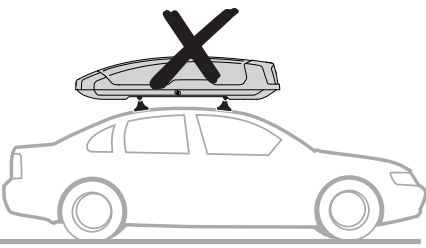

5

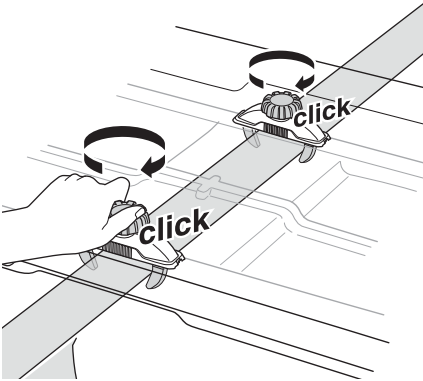
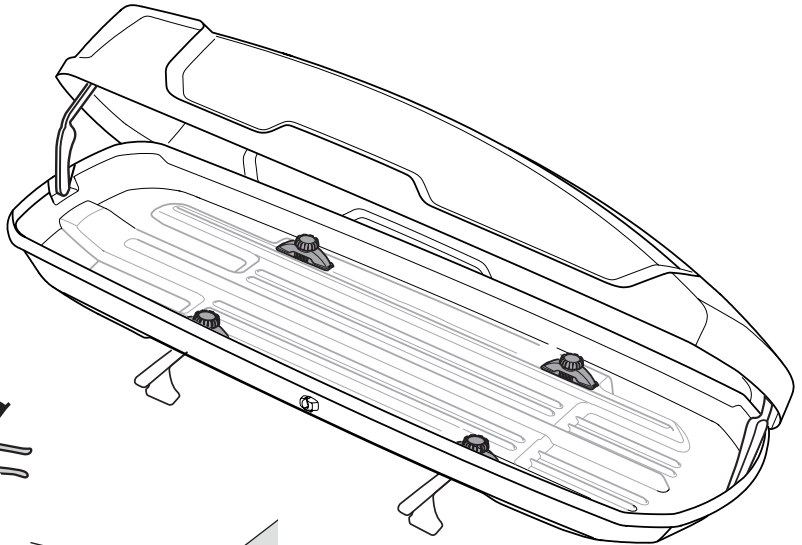

**i**

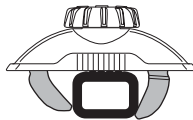
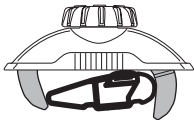
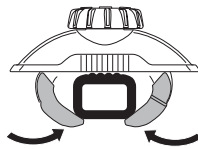
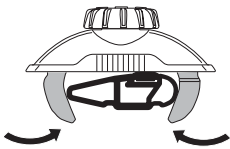
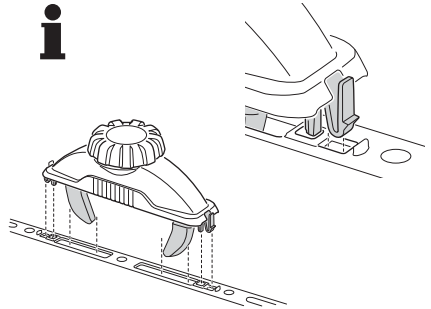



6



x 3

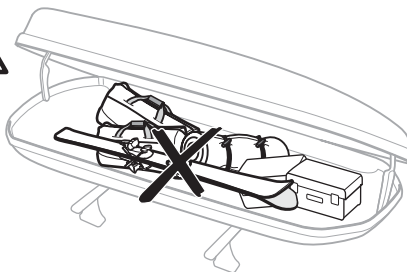
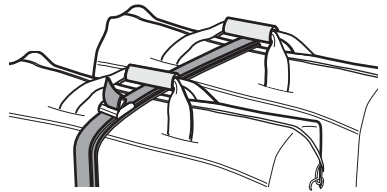
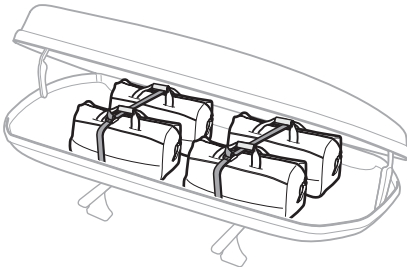
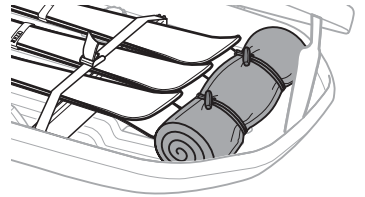
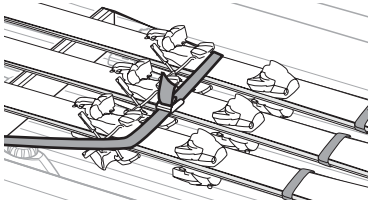
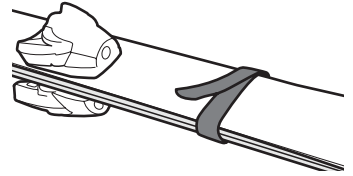
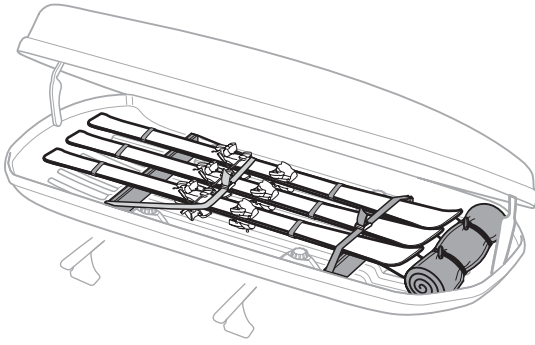
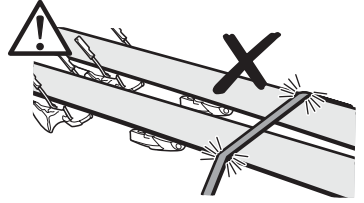
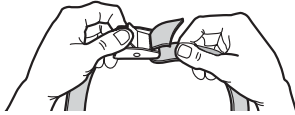

7

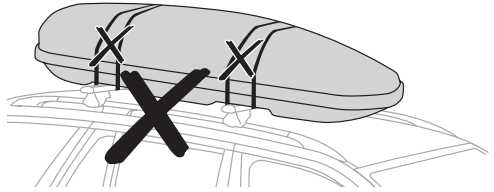
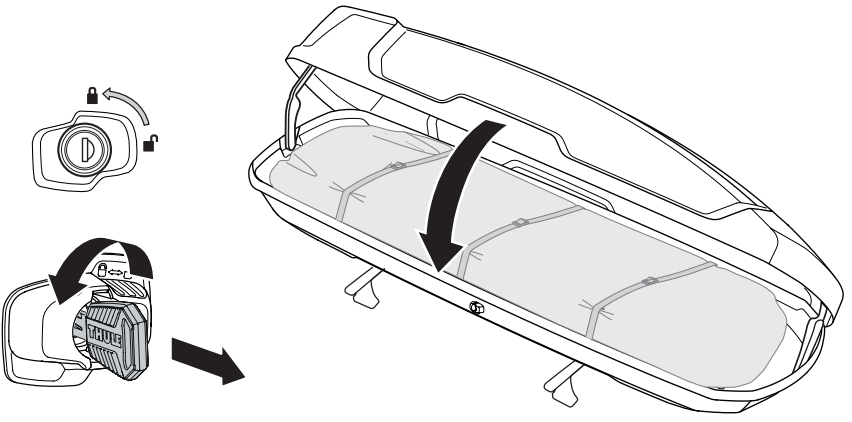

8

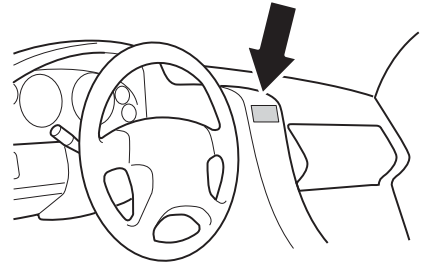
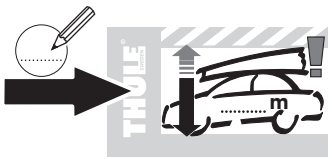
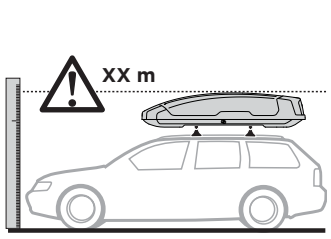
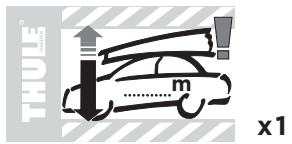

## Thule T-track Adapter

**696600** → 24x30 mm

**697600** → 20x27 mm

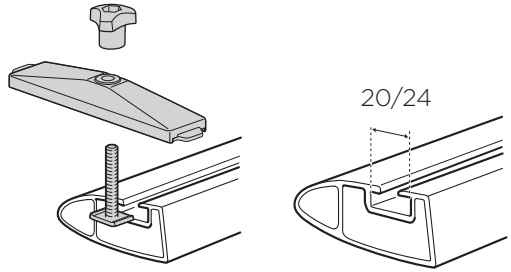

## Thule MultiLift

**572004**

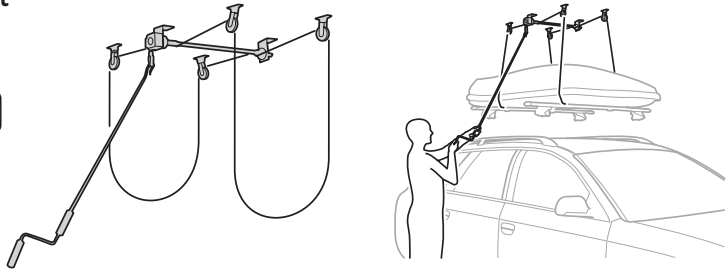

## Thule Box Ski Carrier Adapter

**694500** → Sport

**694700** → Alpine

**694800** → M/L/XL

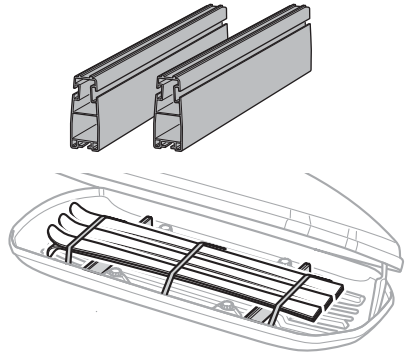

## Thule Box Lid Cover

**698100** → S/M/L

**698200** → Sport/Alpine

**698400** → XL

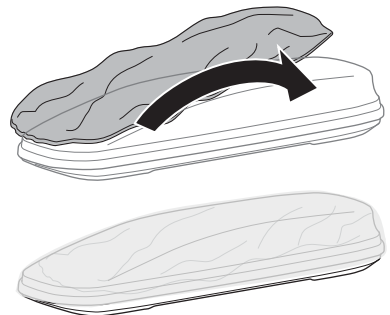

### Thule One-Key System

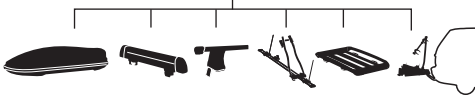

**450400**  (x4)

**450600**  (x6)

**450800**  (x8)

**451200**  (x12)

**451600**  (x16)

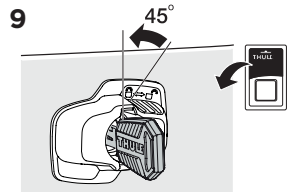
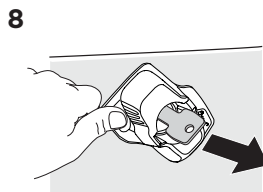
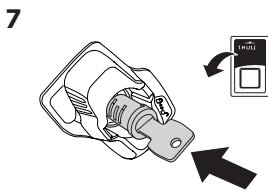
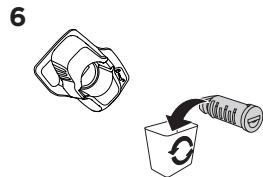
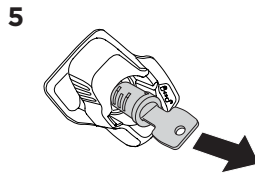
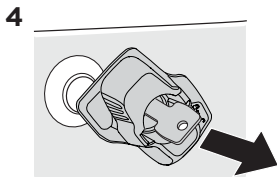
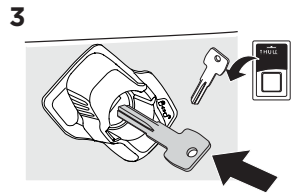
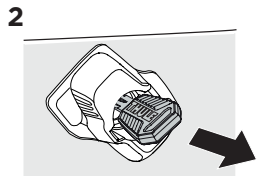
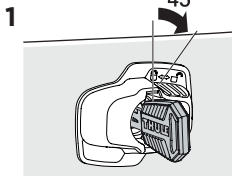

# ➤ Instructions

## Thule Force XT

6356B, 6357B, 6358B, 6359B

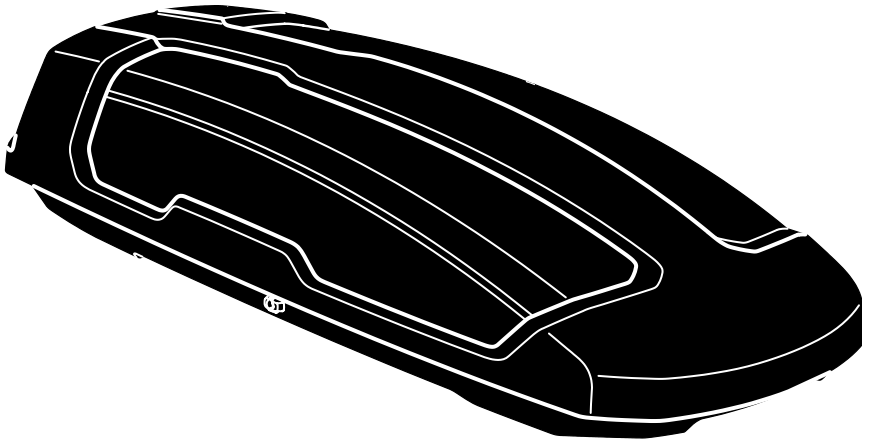

Roof box for roof-mounted racks

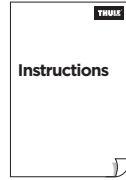

**CITY CRASH**  
Complies with ISO norm

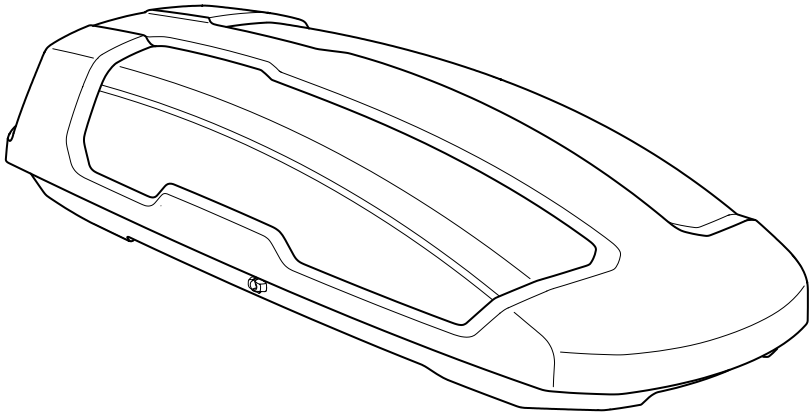

x1



x1

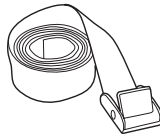

x3



x2

**i**

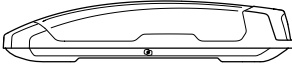
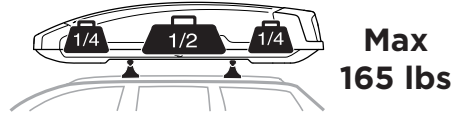

Sport	32.4 lbs
L	41.2 lbs
XL	47 lbs
XXL	51.6 lbs

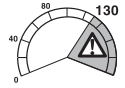
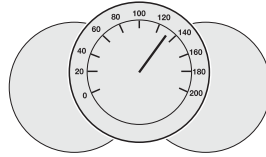

Max  
80 Mph

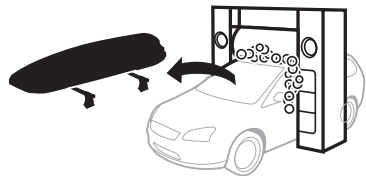
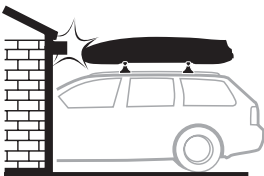
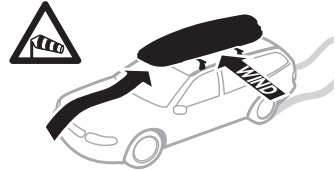
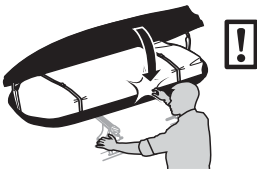
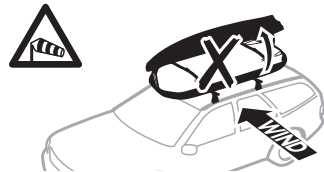
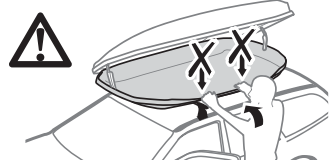
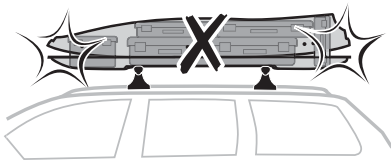

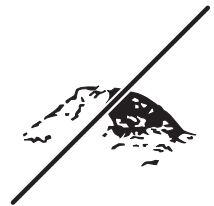
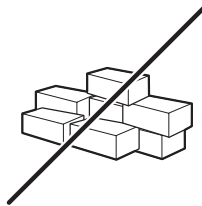
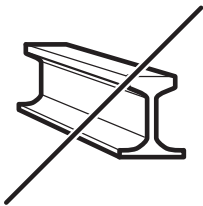
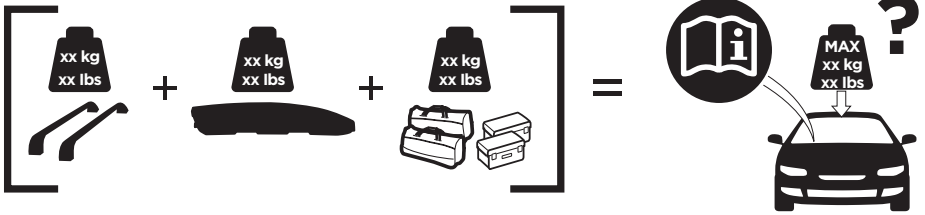
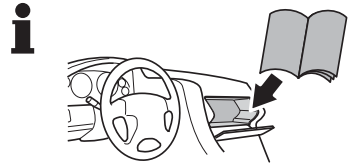
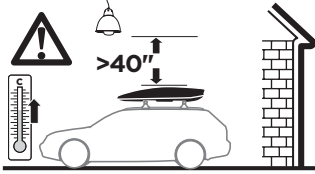
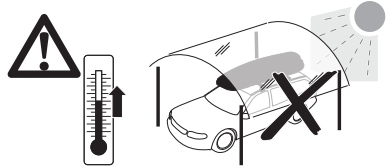
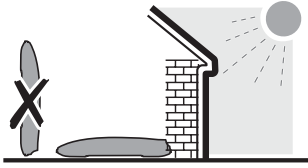



1

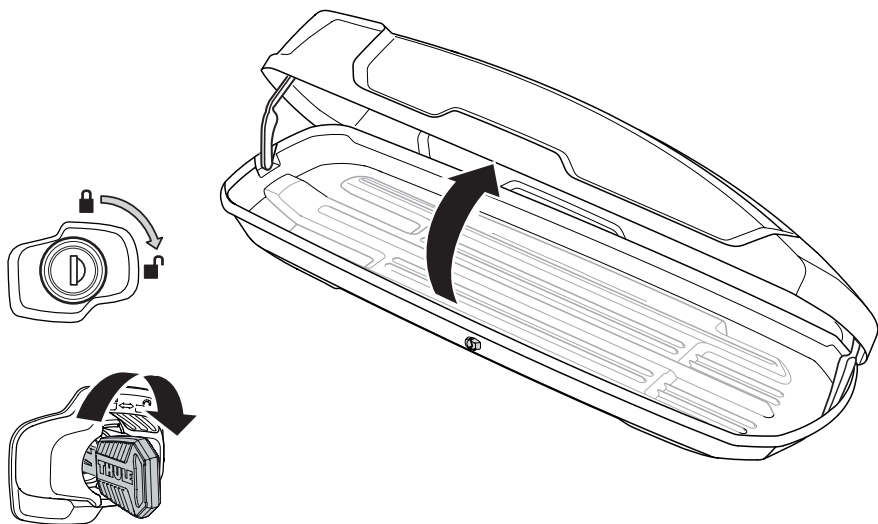

2

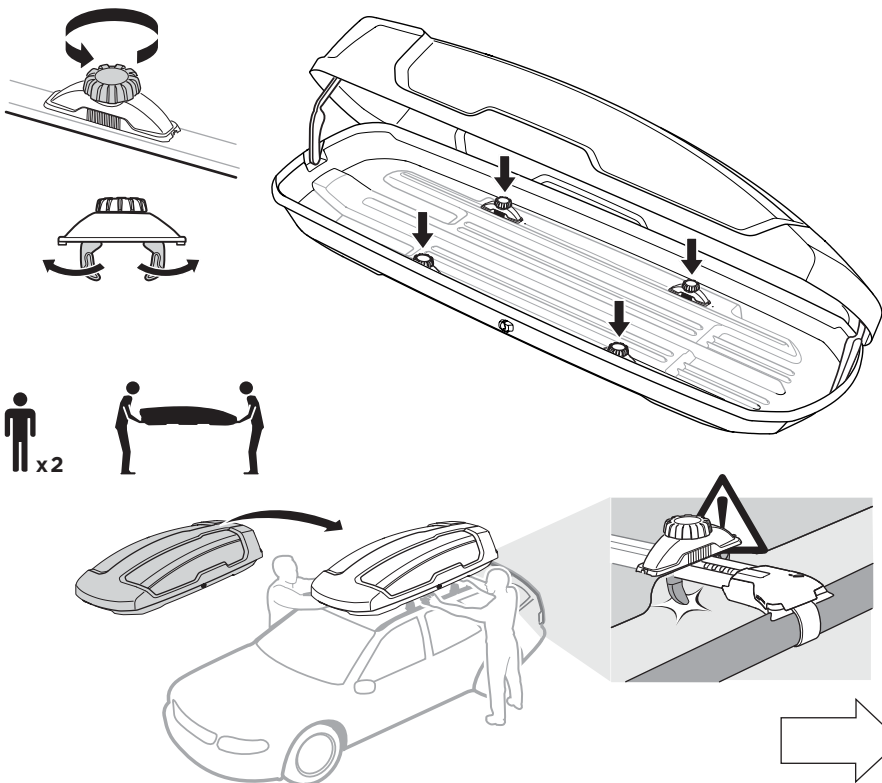

3

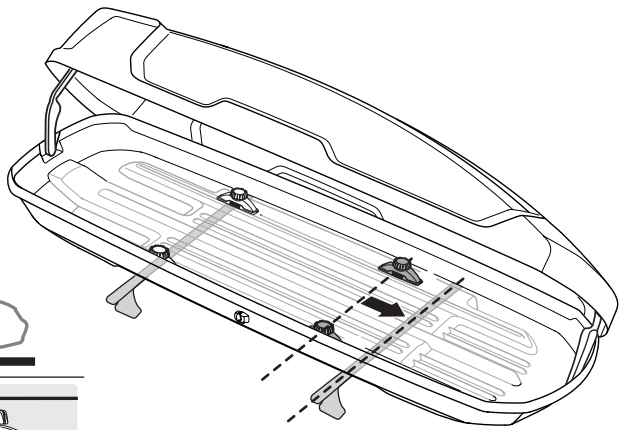
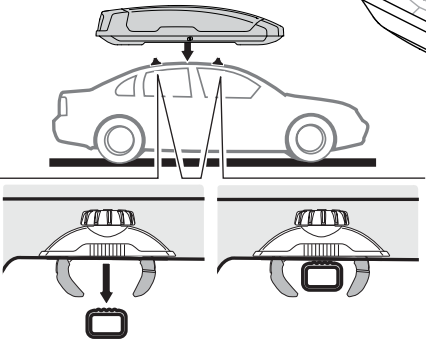
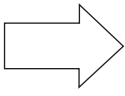

4

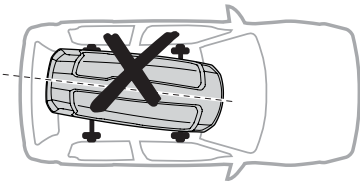
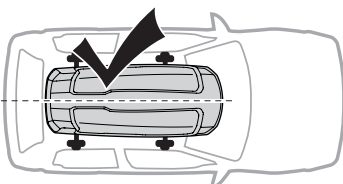
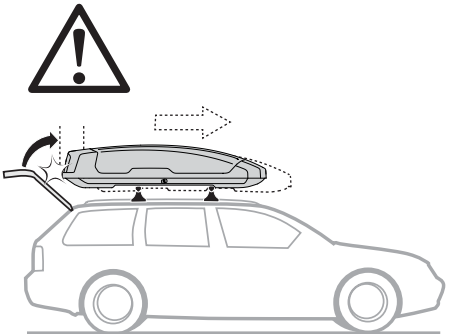
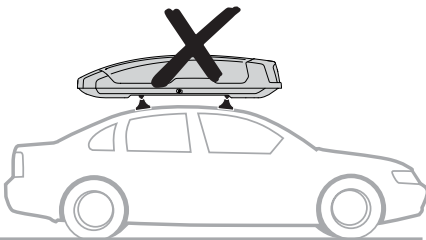

5

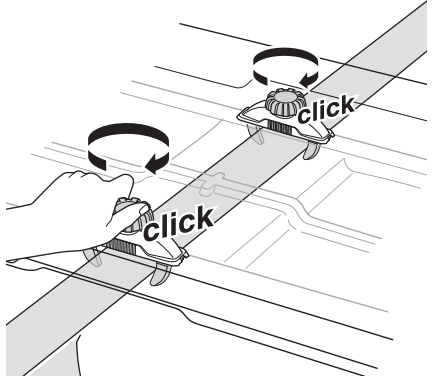
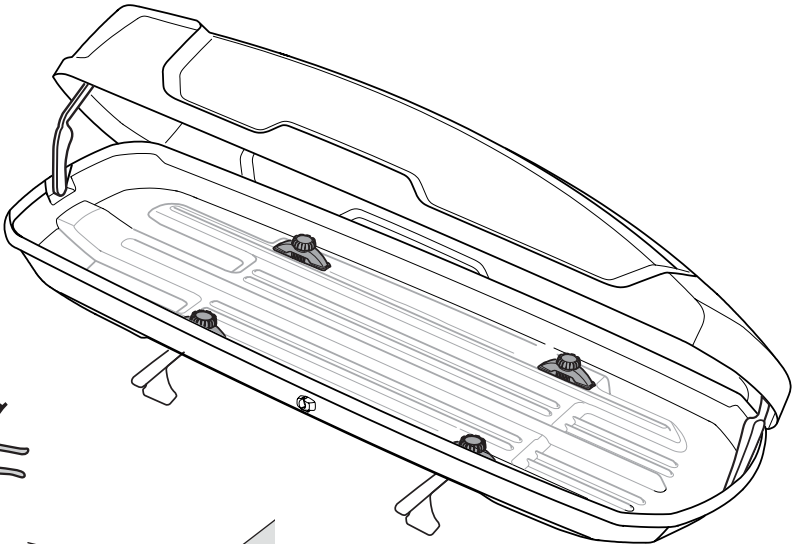

**i**

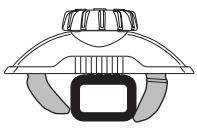
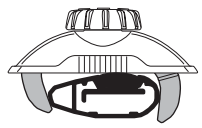
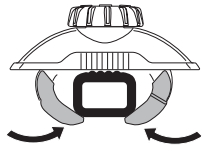
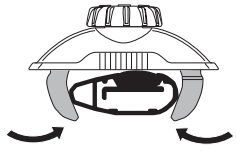
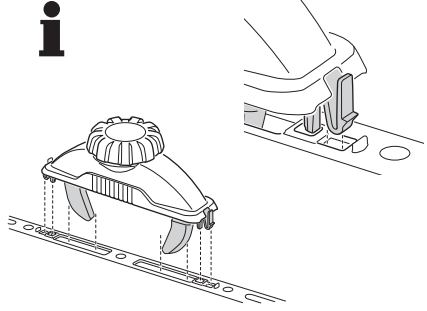

6



x 3

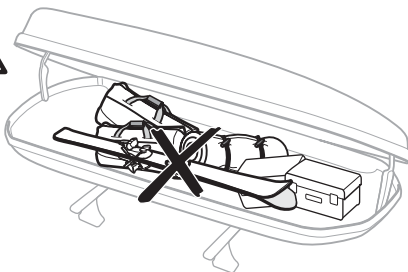
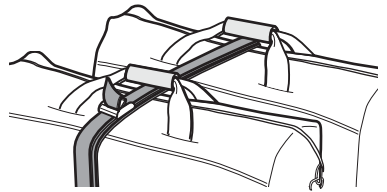
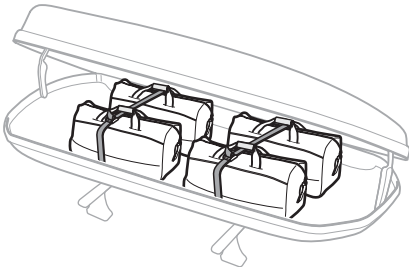
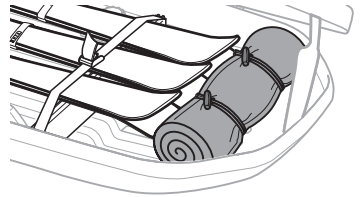
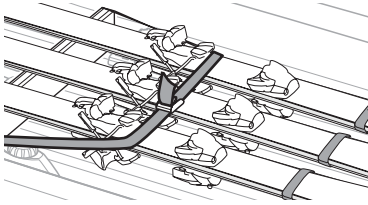
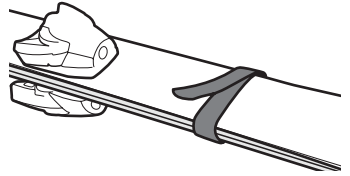
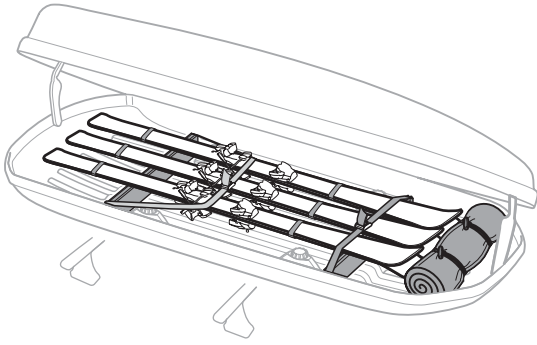
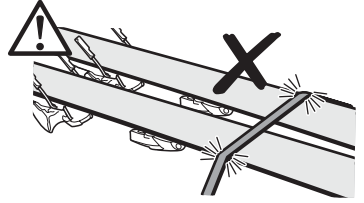
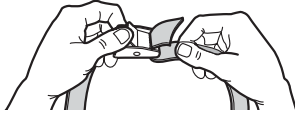

7

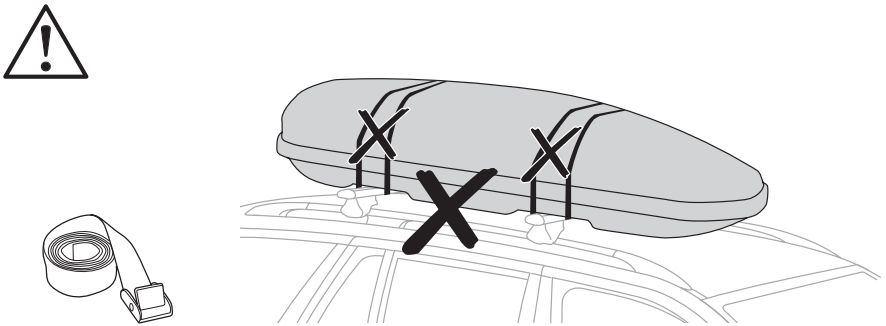
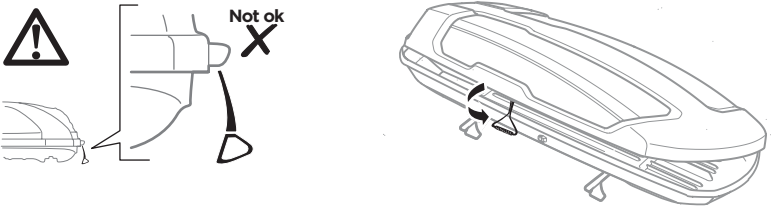
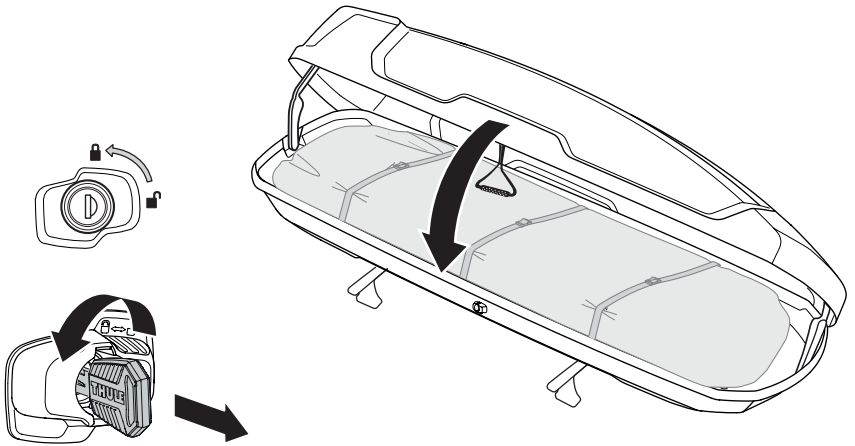

8

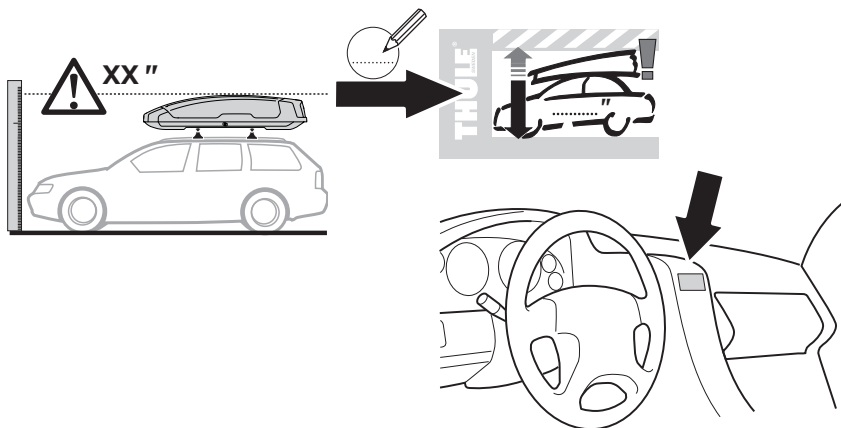

EN Accessories

ES Accesorios

FR Accessoires

PT Acessórios

### Thule One-Key System

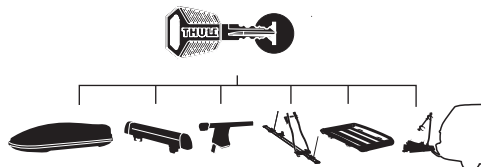

450200 (x2)

450400 (x4)

450600 (x6)

450800 (x8)

### Thule MultiLift

572004

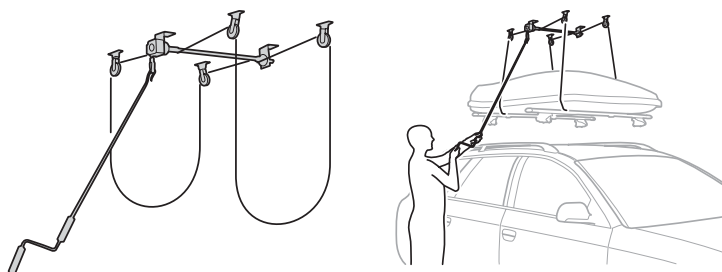

# i

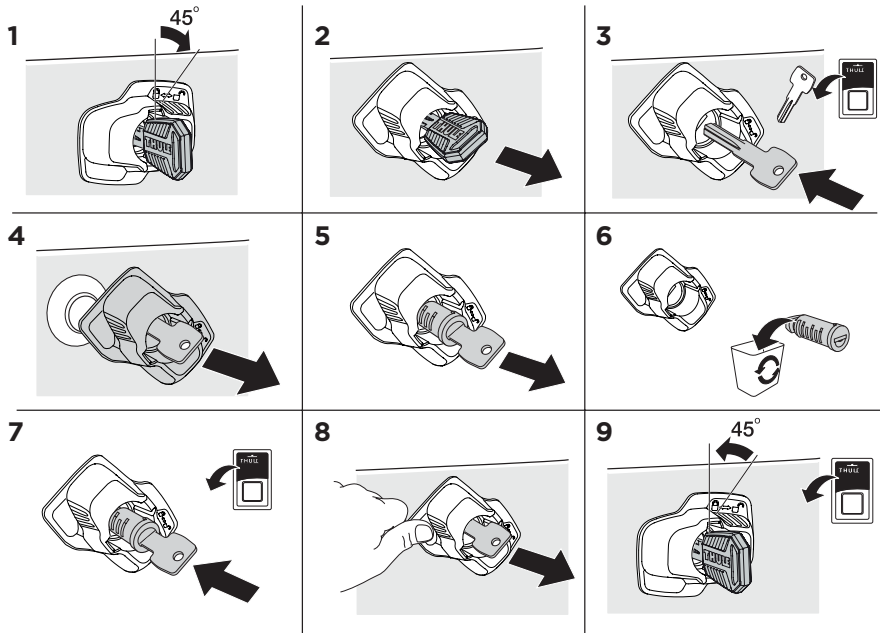

## THULE RACK GUIDELINES

When using Thule Load carriers and accessories, the user must understand the precautions. The points listed below will assist you in using the rack system and will encourage safety.

- For quality fits and safety, use only the recommended rack or accessory as stated in Thule's current Fit Guide. Do not assume a rack will fit, always check the current Fit Guide when obtaining a new vehicle.
- The maximum load specified in the assembly instructions is not to be exceeded. However, this limit is always subordinate to the maximum load recommended by the manufacturer of the car itself. It is always the lower maximum recommended load that applies. Max roof load = load carrier weight + any fitted carrier accessories + the weight of the load itself.
- Always make sure all doors are open when mounting a roof rack system. Make sure all knobs, bolts, screws, straps, and locks are firmly attached, tightened and locked before every trip. Knobs, bolts, screws, straps and locks must be periodically inspected for signs of wear, corrosion, and fatigue. Check your load at stops during the trip to ensure continued fastening security.
- Check local and state laws governing projection of objects beyond the perimeter of a vehicle. Be aware of the width and height of your cargo since low clearance branches, bridges, and parking garages can affect the load. All cargo will affect the vehicle's driving behavior. Never drive with any lock, knob or rack in an open or unlocked position. All long loads such as, but not limited to, sailboards, surfboards, kayaks, canoes, and lumber must be tied down front and rear to the bumpers or tow hooks of the vehicle.
- Remove your Thule rack and accessories when they are not in use and before entering automatic car washes.
- All locks must be turned and moved periodically to ensure smooth operation. Use graphite or dry lubricant to help this. Thule locks are designed to deter vandalism and theft but should not be considered theft proof. Remove valuable gear if your vehicle is unattended for an extended period. Place at least one key in the glove compartment.
- For safety to your vehicle and rack system, obey all posted speed limits and traffic cautions. Adapt your speed to the conditions of the road and the load being carried.
- Do not use Thule load carriers and accessories for purposes other than those for which they were designed. Do not exceed their carrying capacity. Failure to follow these guidelines or the product's instructions will void the warranty.
- All loads must be secured using the provided straps.
- Consult with your Thule dealer if you have any questions regarding the operations and limits of Thule products. Review all instructions and warranty information carefully.
- Not for use on trailers or towed vehicles.
- Not for offroad use.
- Keep bicycle tires away from hot exhaust.

