

# 1

## Kit 5063

FORD Ranger, 4-dr Double Cab, 11-  
 FORD Ranger, 4-dr Super Cab, 11-



ISO 11154-E

### 1 KIT

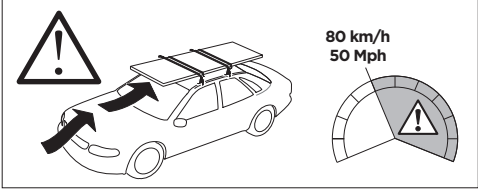
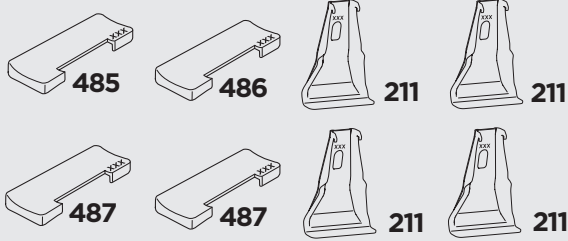
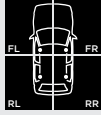
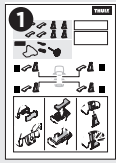

### 2 FOOT PACK

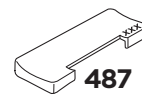
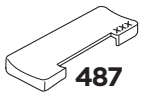
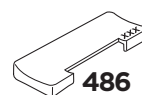
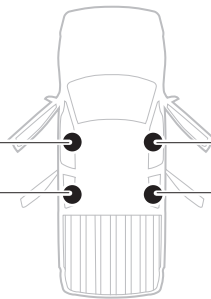
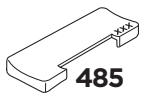
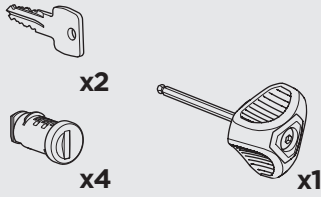
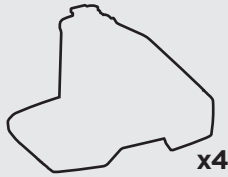

### 1



### 2

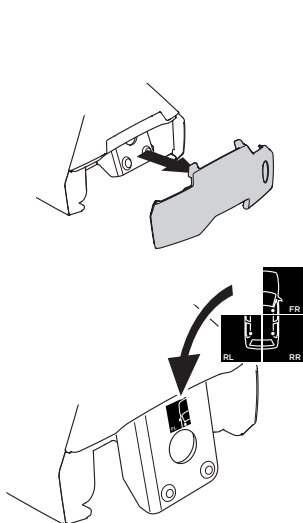

x4

### 3

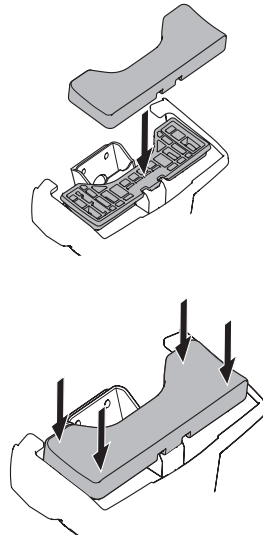

x4

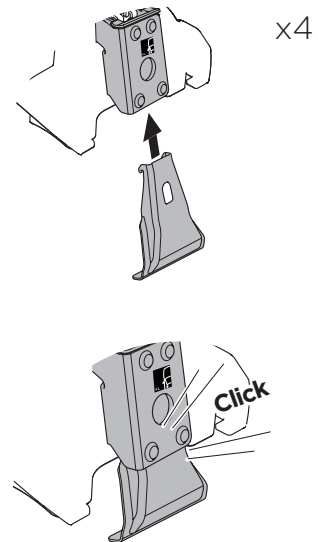

x4



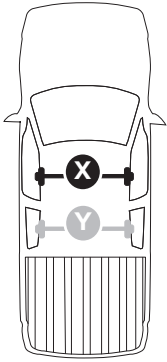

THULE WingBar Evo	THULE WingBar Edge	THULE WingBar	THULE SquareBar	<b>Evo X (scale)</b>	<b>Edge X (scale)</b>
<b>FORD Ranger, 4-dr Double Cab, 11-</b>				<b>47</b>	<b>C</b>
<b>FORD Ranger, 4-dr Super Cab, 11-</b>				<b>47</b>	<b>C</b>

THULE ProBar	THULE SlideBar			<b>X (mm/inch)</b>	
<b>FORD Ranger, 4-dr Double Cab, 11-</b>				<b>1121 mm / 44 1/8"</b>	
<b>FORD Ranger, 4-dr Super Cab, 11-</b>				<b>1121 mm / 44 1/8"</b>	

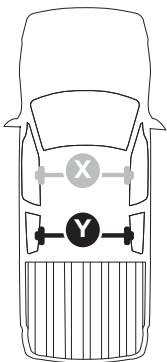

THULE WingBar Evo	THULE WingBar Edge	THULE WingBar	THULE SquareBar	<b>Evo Y (scale)</b>	<b>Edge Y (scale)</b>
<b>FORD Ranger, 4-dr Double Cab, 11-</b>				<b>44,5</b>	<b>H</b>
<b>FORD Ranger, 4-dr Super Cab, 11-</b>				<b>44,5</b>	<b>H</b>

THULE ProBar	THULE SlideBar			<b>Y (mm/inch)</b>	
<b>FORD Ranger, 4-dr Double Cab, 11-</b>				<b>1096 mm / 43 1/8"</b>	
<b>FORD Ranger, 4-dr Super Cab, 11-</b>				<b>1096 mm / 43 1/8"</b>	

	<b>W (mm/inch)</b>	<b>Z (mm/inch)</b>
<b>FORD Ranger, 4-dr Double Cab, 11-</b>	<b>600 mm / 23 5/8"</b>	<b>185 mm / 7 1/4"</b>
<b>FORD Ranger, 4-dr Super Cab, 11-</b>	<b>600 mm / 23 5/8"</b>	<b>185 mm / 7 1/4"</b>

