

Kit 3093

MITSUBISHI ASX, 5-dr SUV, 10-

This Kit is only for vehicles with fixpoint mounting.

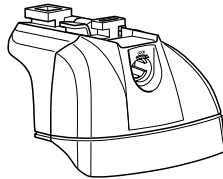

460R
753

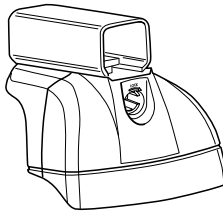
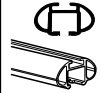

460

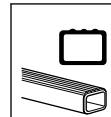

- 16 x 4
- 13 x 1
- 14 x 1
- 15 x 1
- 16 x 1
- 17 x 1
- 18 x 1
- 19 x 1
- 20 x 1
- 50961
- x 4
- x 4
- x 4
- 3 mm x 1
- x 1

Kit

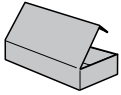

753

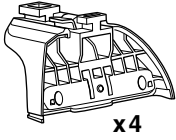

x4



x4



x4



x8

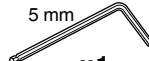

x1



x4



x1

460R

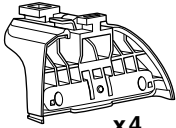

x4



x4



x4



x8

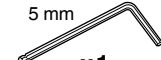

x1



x4

460

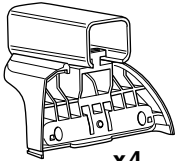

x4



x4



x4



x8

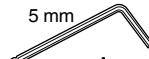

x1



x4

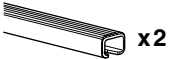
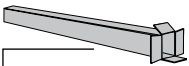

x2



x1

17 mm

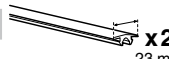

x2

23 mm

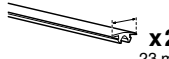

x2

23 mm

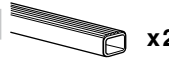

x2

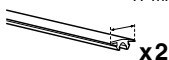

x2

23 mm

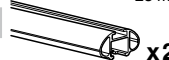

x2

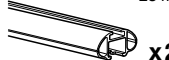

x2

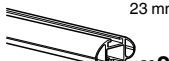

x2



x4



x4



x4

1

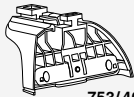

753/460R

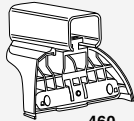

460

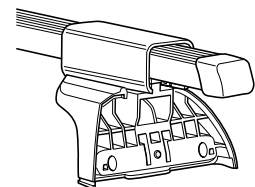
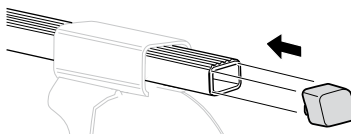
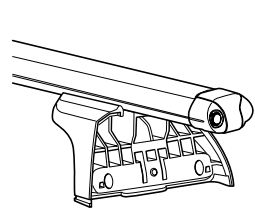
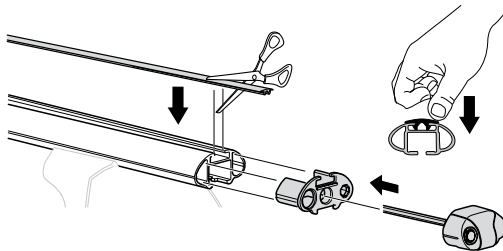
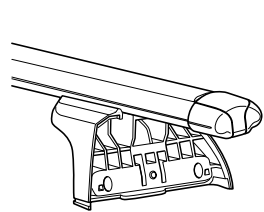
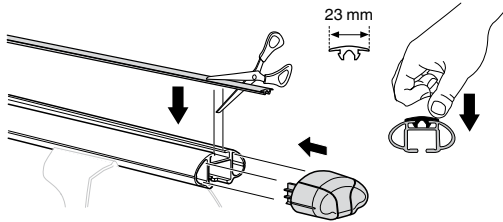
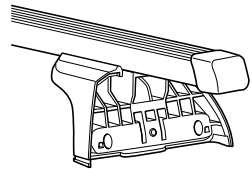
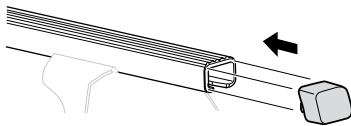
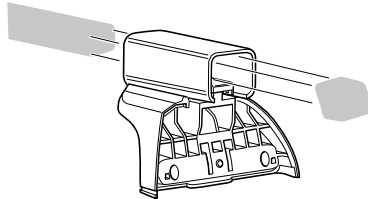
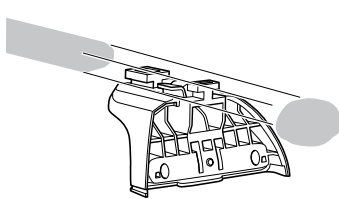

2

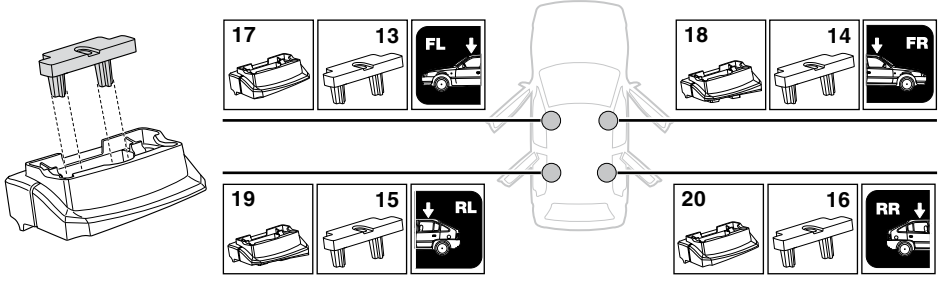
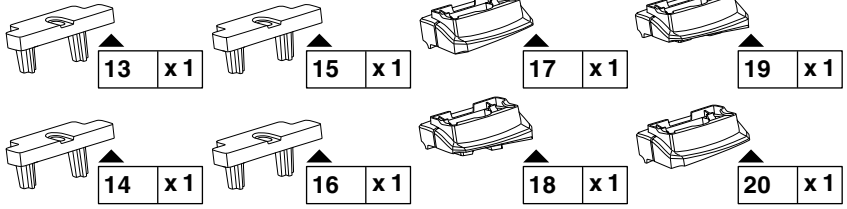

3

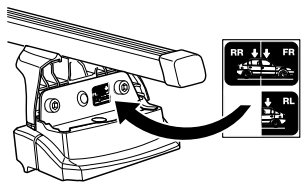
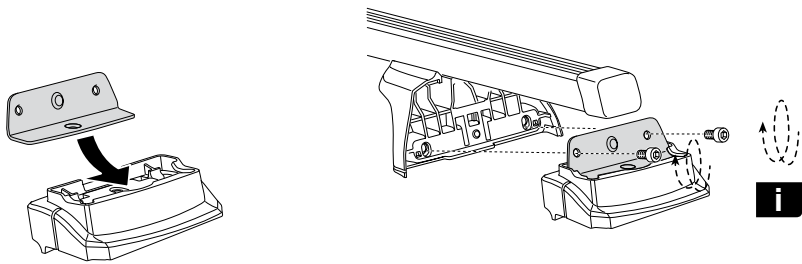
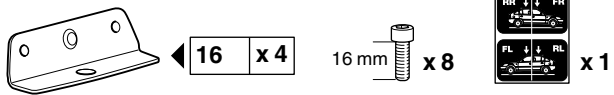

i			
GB	Only a few turns	RU	Достаточно нескольких оборотов
D	Nur wenige Umdrehungen	CZ	Pouze několik otáček
F	Quelques tours uniquement	SK	Len niekoľko otáčok
NL	Slechts enkele slagen	SLO	Le nekaj obratov
I	Solo qualche giro	HR	Samo nekoliko okreta
E	Sólo algunas vueltas	HU	Csak néhány fordítás
PT	Noções básicas	GR	Μόνο μερικές στροφές
S	Endast några varv	TR	Yalnız birkaç kez çevirm
FIN	Vain muutama kierros	中文	只有几个转向
EST	Ainult mõni pööre	한국어	두 세번만
LAT	Tikai dažī apgriezieni	日本語	数回転のみ
LIT	Tik keli pasukimai	ไทย	หมุนเพียงไม่กี่รอบ
PL	Wystarczy kilka obrotów		

4

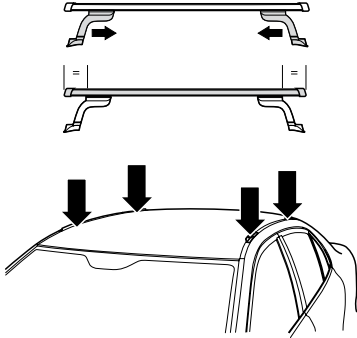
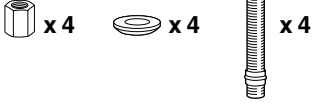

A

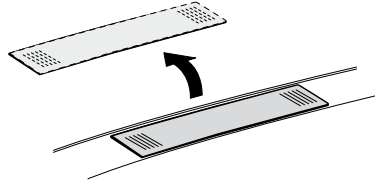

C

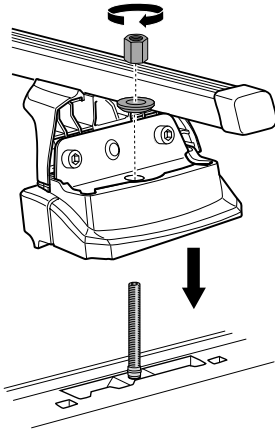

B

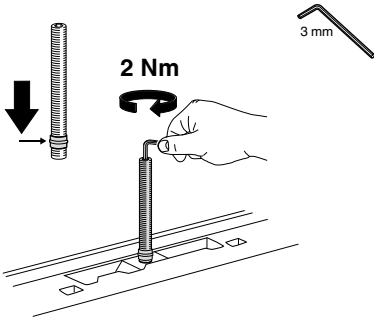

D

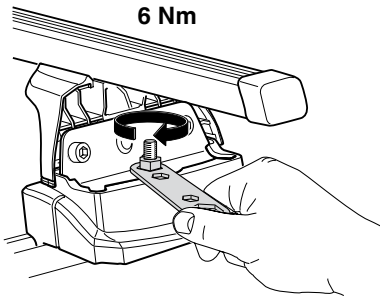

E

