

# Kit 3080

**MAZDA 5**, 5-dr MPV, 04–

**MAZDA 5**, 5-dr Hatchback, \*06–

**MAZDA Biante**, 5-dr MPV, 08–

**MAZDA Premacy**, 5-dr MPV, 04–

This Kit is only for vehicles with fixpoint mounting.

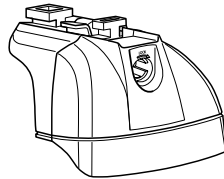

**460R**  
**753**

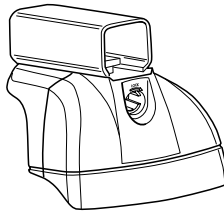

**460**

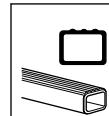

**Kit**

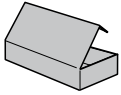

753

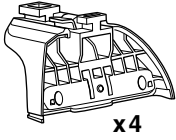

x4



x4



x4



x8



x1



x4



x1

460R

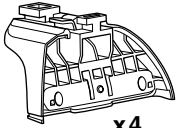

x4



x4



x4



x8



x1



x4

460

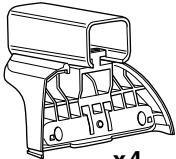

x4



x4



x4



x8

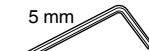

x1



x4

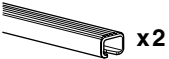
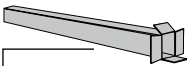

x2



x2

17 mm

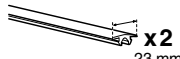

x2

23 mm



x2

23 mm

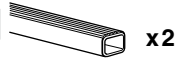

x2

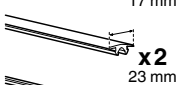

x2

23 mm

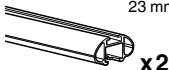

x2



x4

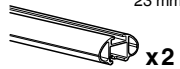

x2



x4



x4

1

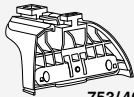

753/460R

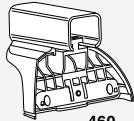

460

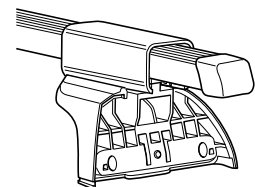
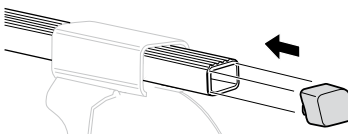
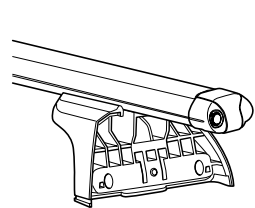
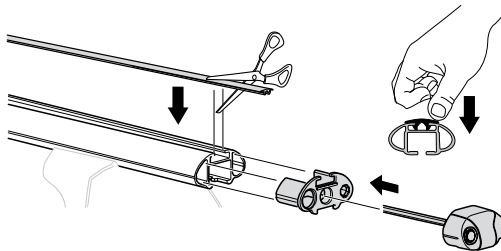
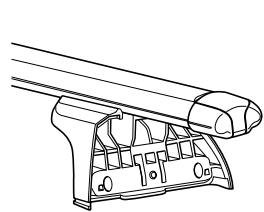
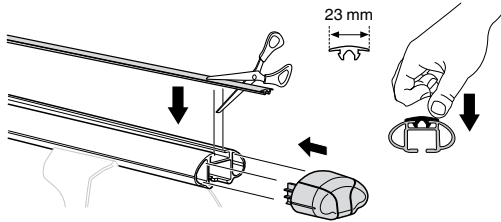
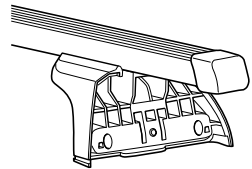
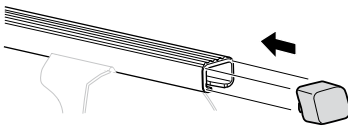
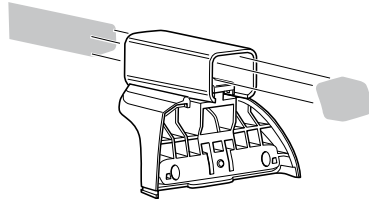
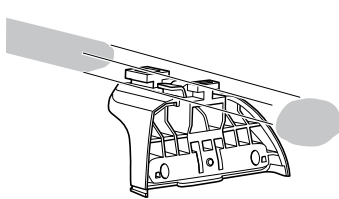

2

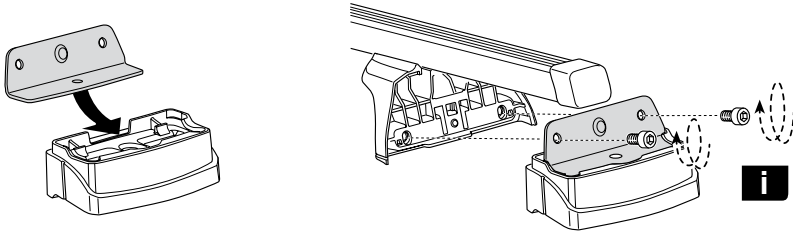
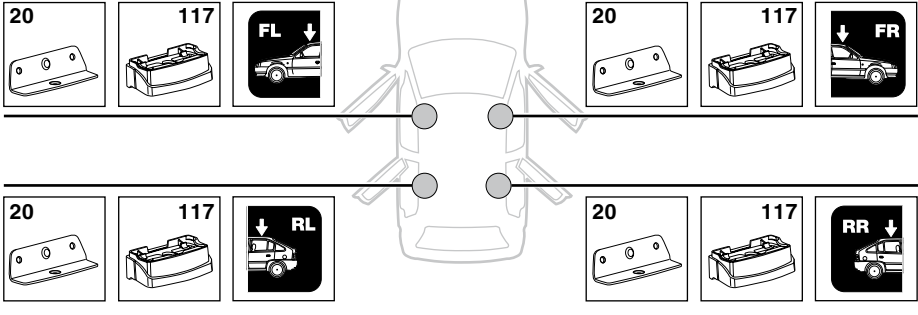
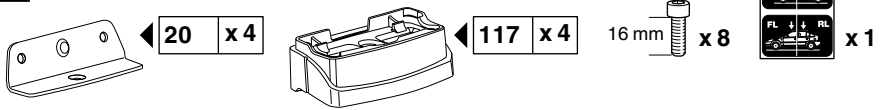

<b>i</b>	<b>GB</b> Only a few turns	<b>EST</b> Ainult mõni pööre	<b>HR</b> Samo nekoliko okreta
	<b>D</b> Nur wenige Umdrehungen	<b>LAT</b> Tikai dažī apgriezieni	<b>HU</b> Csak néhány fordítás
	<b>F</b> Quelques tours uniquement	<b>LIT</b> Tik keli pasukimai	<b>GR</b> Μόνο μερικές στροφές
	<b>NL</b> Slechts enkele slagen	<b>PL</b> Wystarczy kilka obrotów	<b>TR</b> Yalnız birkaç kez çevirm
	<b>I</b> Solo qualche giro	<b>RU</b> Достаточно нескольких оборотов	<b>中文</b> 只有几个转向
	<b>E</b> Sólo algunas vueltas	<b>CZ</b> Pouze několik otáček	<b>한국어</b> 두 세번만
	<b>PT</b> Noções básicas	<b>SK</b> Len niekoľko otáčok	<b>日本語</b> 数回転のみ
	<b>S</b> Endast några varv	<b>SLO</b> Le nekaj obratov	<b>ไทย</b> หมุนเพียงไม่กี่รอบ
	<b>FIN</b> Vain muutama kierros		

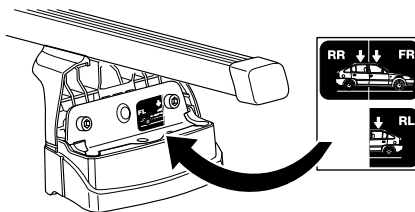

**3**

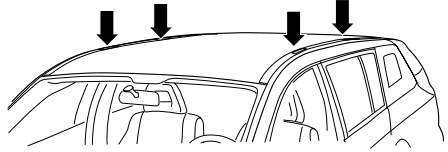
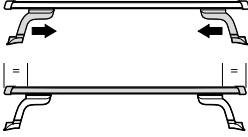
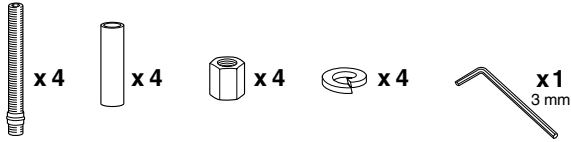

**A**

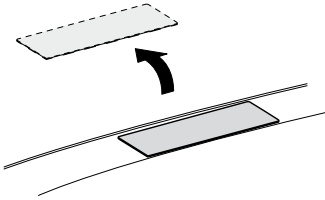

**B**

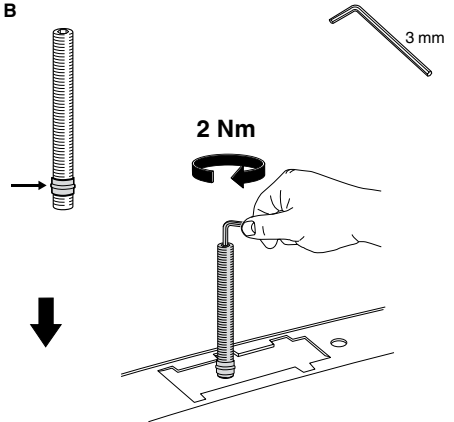

**C**

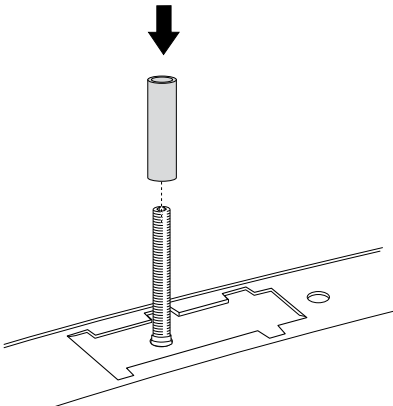

**D**

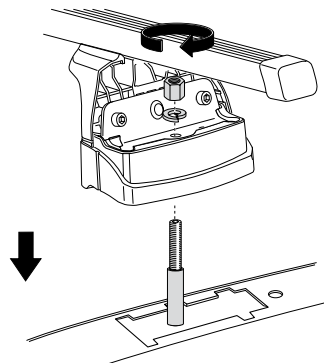

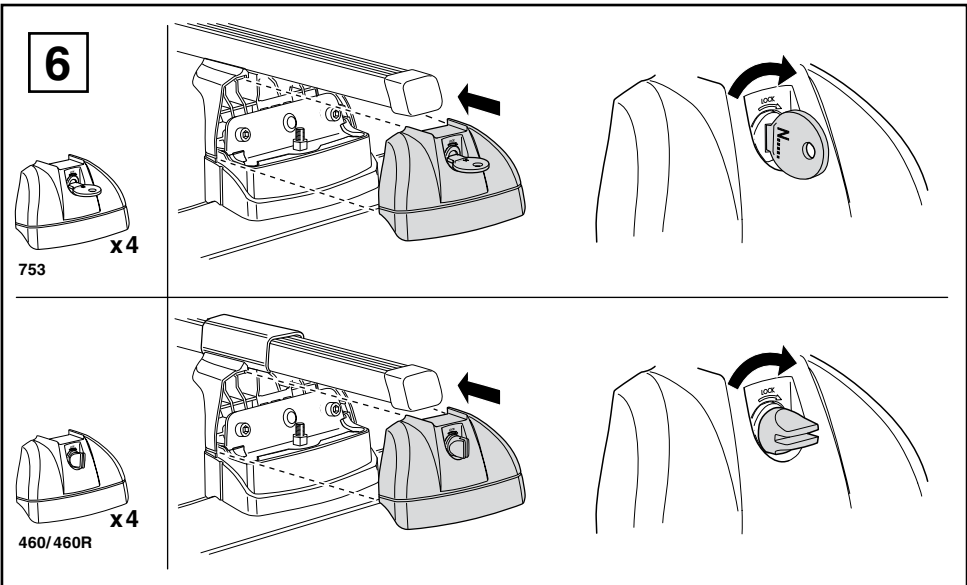
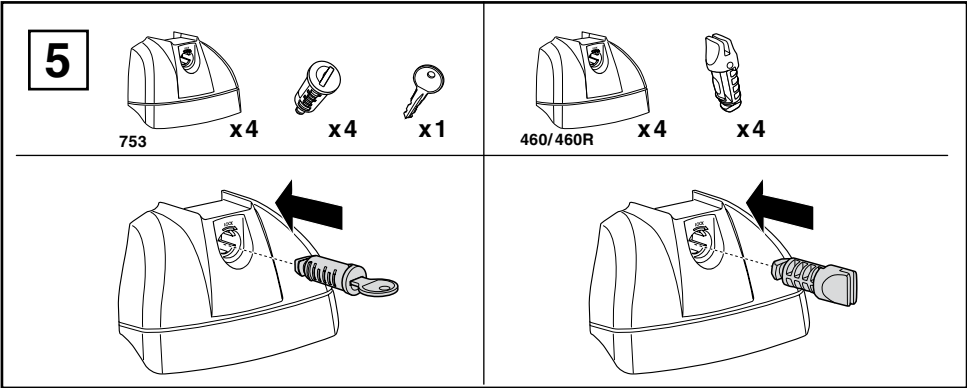
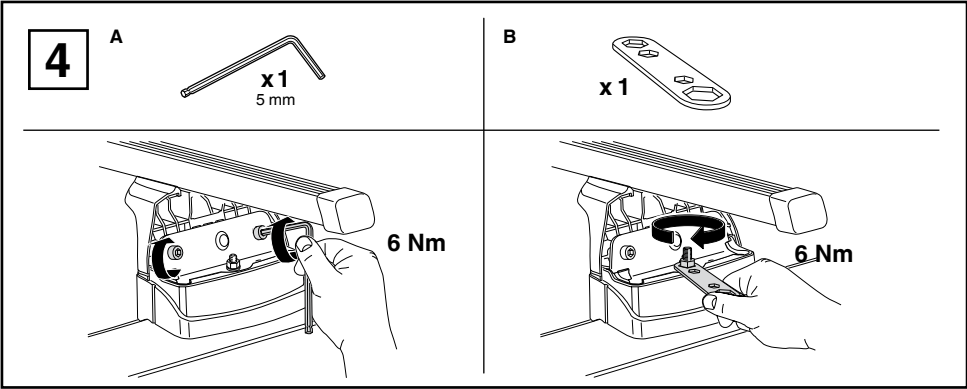

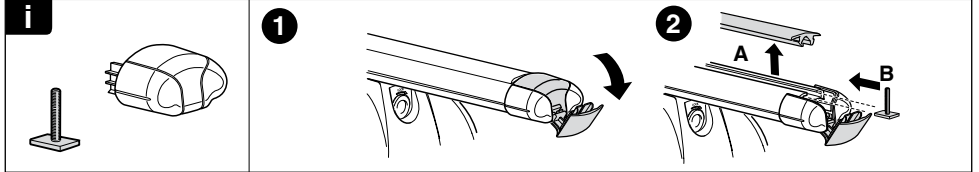
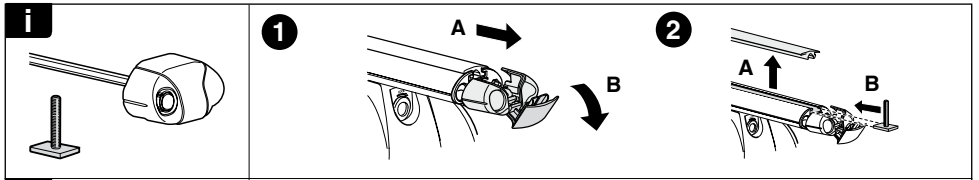
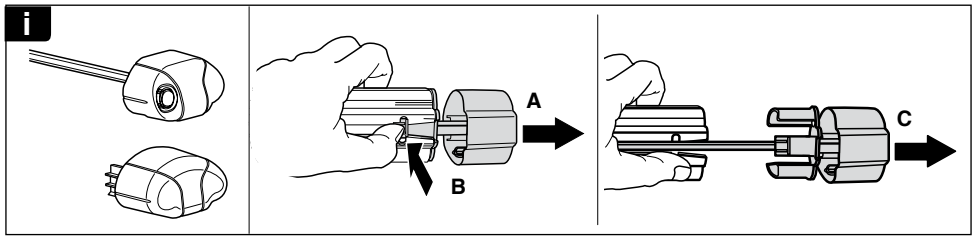
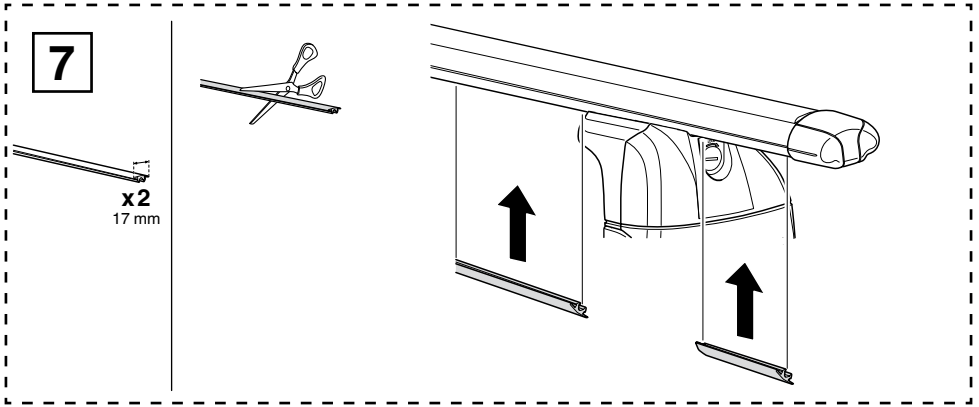

**THULE**  
SWEDEN

**ONE  
KEY  
SYSTEM**

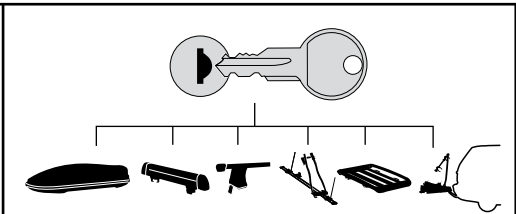

- 544** (x4)
- 596** (x6)
- 588** (x8)
- NA 510** (x10)
- EUR ASIA 452** (x12)