

Kit 3021

FIAT Doblo, 3-dr Van, 00-03, 04-05, 06-09

FIAT Doblo, 4-dr Van, 00-03, 04-05, 06-09

FIAT Doblo, 5-dr Van, 00-03, 04-05, 06-09

FIAT Doblo Maxi, 4-dr Van, 08-09

FORD Tourneo Connect, 5-dr Bus, 03–

FORD Transit Connect, 4-dr Van, 03–

NISSAN Kubistar, 5-dr Van, 04–

RENAULT Kangoo, 5-dr Van, 98-02, 03-07, 08–

This Kit is only for vehicles with fixpoint mounting.

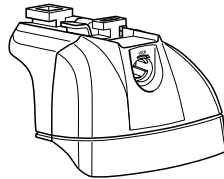

460R
753

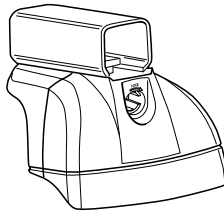
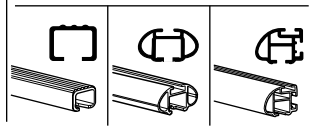

460

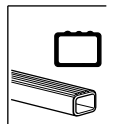

Kit

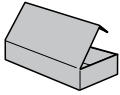

753

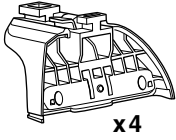

x4



x4



x4



x8

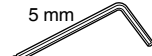

x1



x4



x1

460R

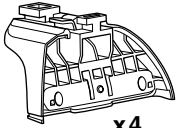

x4



x4



x4



x8



x1



x4

460

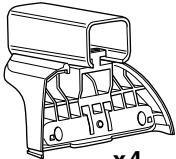

x4



x4



x4



x8



x1



x4

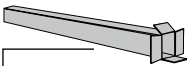

x2



x1

17 mm



x2

23 mm



x2

23 mm



x2



x2

17 mm

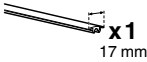

x2

23 mm

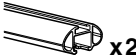

x2

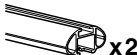

x2

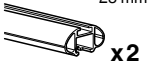

x2



x4

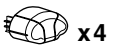

x4



x4

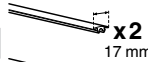

x2

17 mm

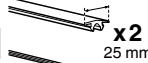

x2

25 mm

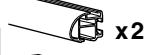

x2

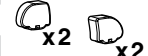

x2

x2



x4

x4



x1

5 mm

1

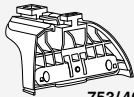

753/460R

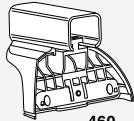

460

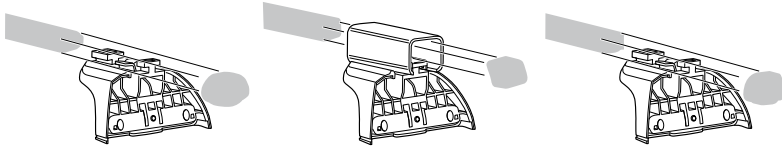

x4

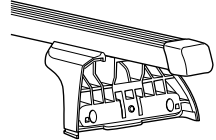
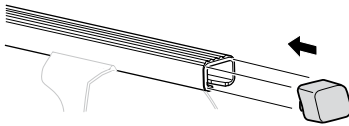

x4

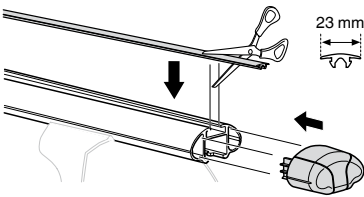

23 mm

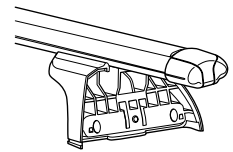
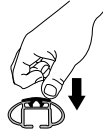

x4

x4

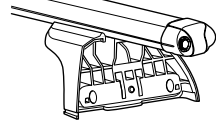
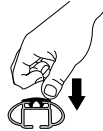
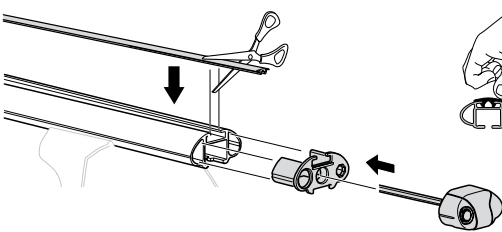

x4

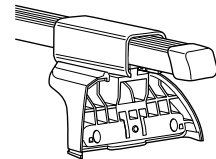
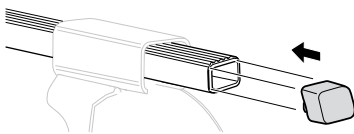

x2

x2

x4

x4

x1
5 mm

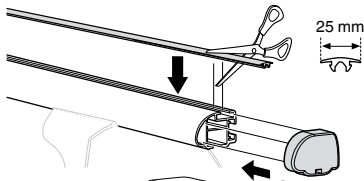

25 mm

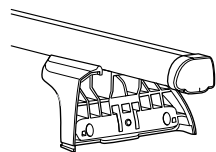
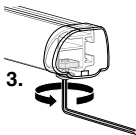
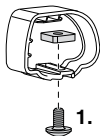
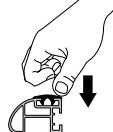

2

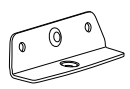

01 x 4

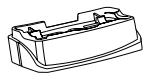

26 x 2

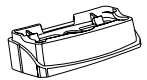

27 x 2

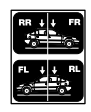
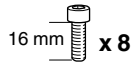

x 8

x 1

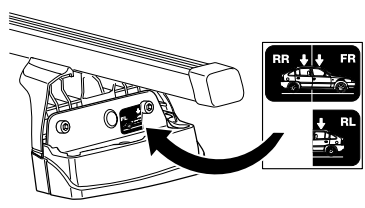
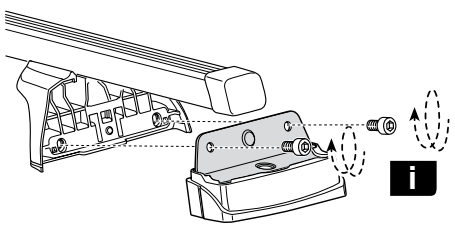
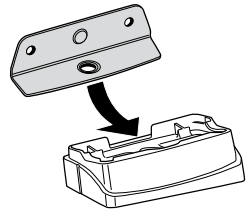
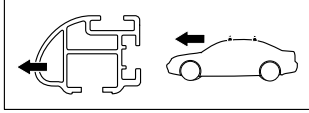
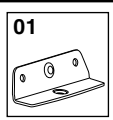
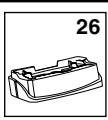
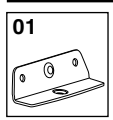
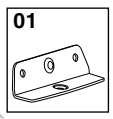
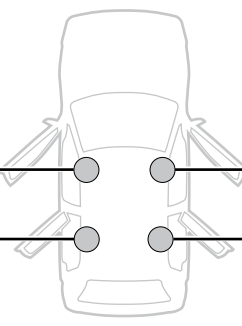
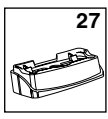
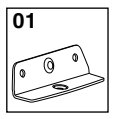

i

- GB** Only a few turns
- D** Nur wenige Umdrehungen
- F** Quelques tours uniquement
- NL** Slechts enkele slagen
- I** Solo qualche giro
- E** Sólo algunas vueltas
- PT** Noções básicas
- S** Endast några varv
- FIN** Vain muutama kierros

- EST** Ainult mõni pööre
- LAT** Tikai dažī apgriezieni
- LIT** Tik keli pasukimai
- PL** Wystarczy kilka obrotów
- RU** Достаточно нескольких оборотов
- CZ** Pouze několik otáček
- SK** Len niekoľko otáčok
- SLO** Le nekaj obratov

- HR** Samo nekoliko okreta
- HU** Csak néhány fordítás
- GR** Μόνο μερικές στροφές
- TR** Yalnız birkaç kez çevirm
- 中文** 只有几个转向
- 한국어** 두 세번만
- 日本語** 数回転のみ
- ไทย** หมุนเพียงไม่กี่รอบ

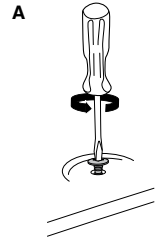
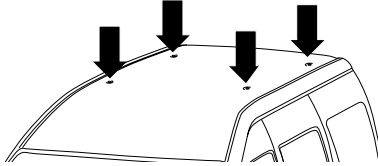
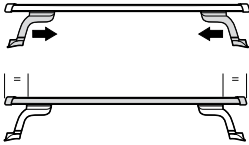
3

B **FIAT Doblo**, 3-dr Van, 00-03, 04-05, 06-09
FIAT Doblo, 4-dr Van, 00-03, 04-05, 06-09
FIAT Doblo, 5-dr Van, 00-03, 04-05, 06-09
FIAT Doblo Maxi, 4-dr Van, 08-09

FORD Tourneo Connect, 5-dr Bus, 03-
FORD Transit Connect, 4-dr Van, 03-
NISSAN Kubistar, 5-dr Van, 04-
RENAULT Kangoo, 5-dr Van, 98-02, 03-07, 08-

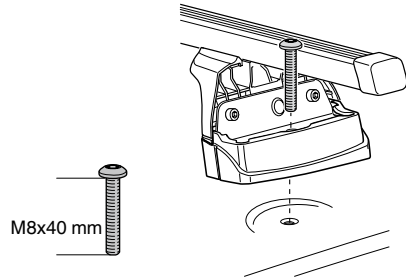
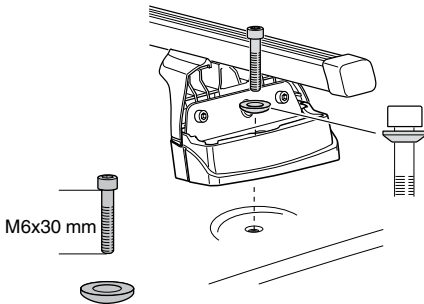
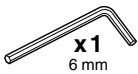
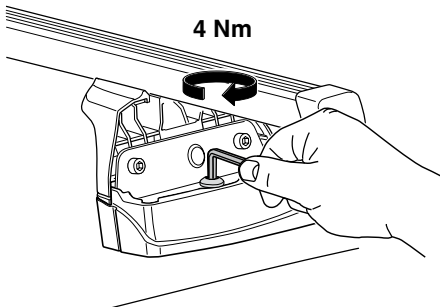
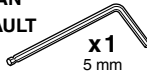
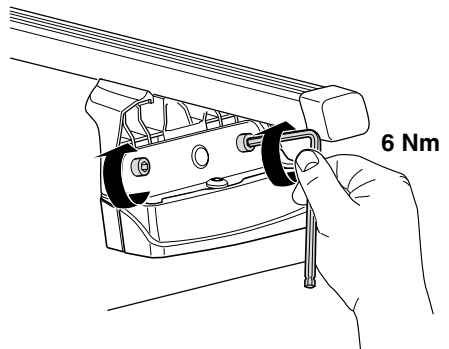
**C** **FIAT****FORD
NISSAN
RENAULT****D**

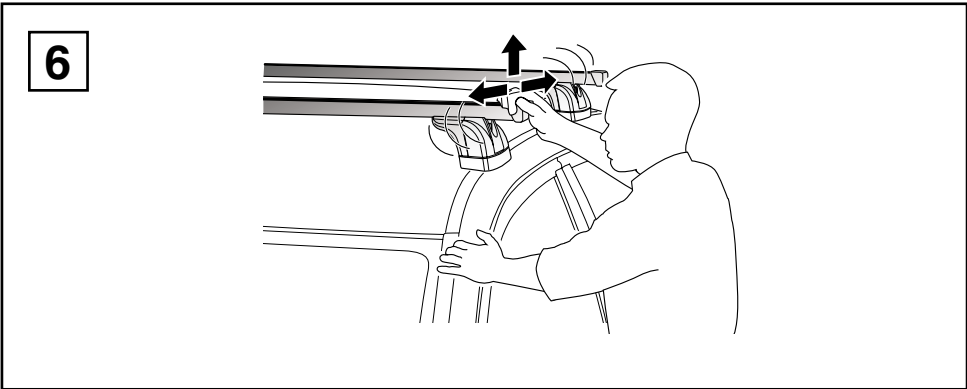
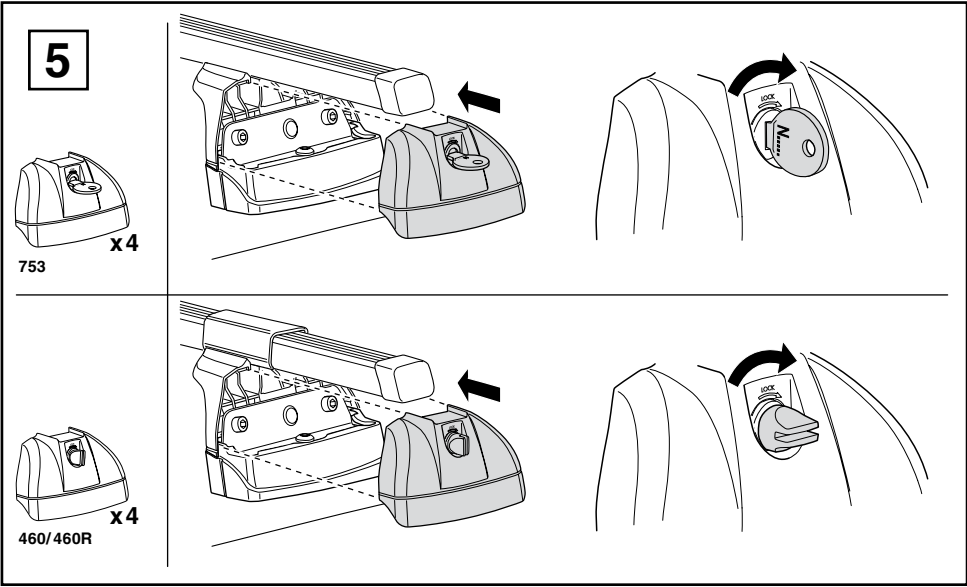
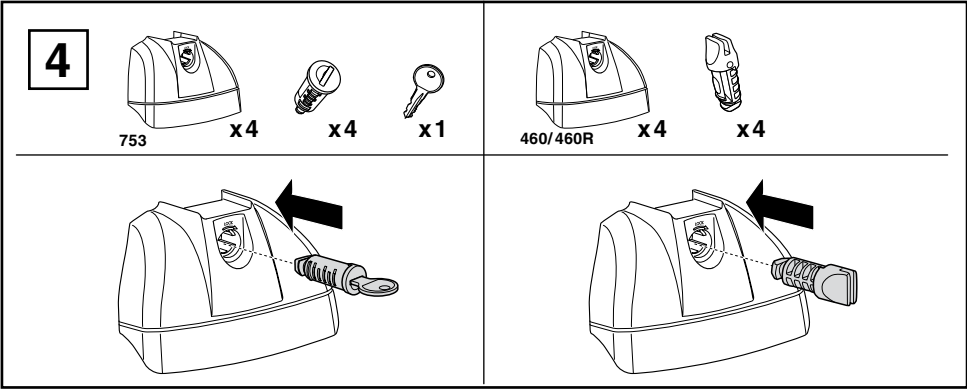

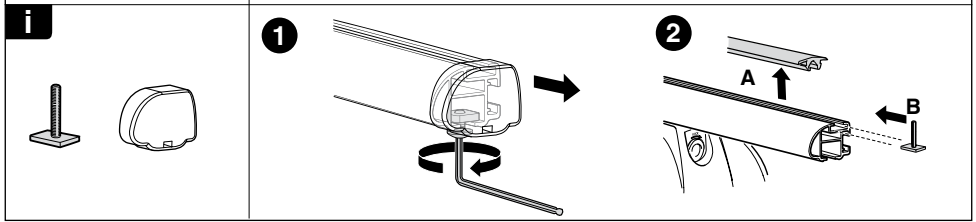
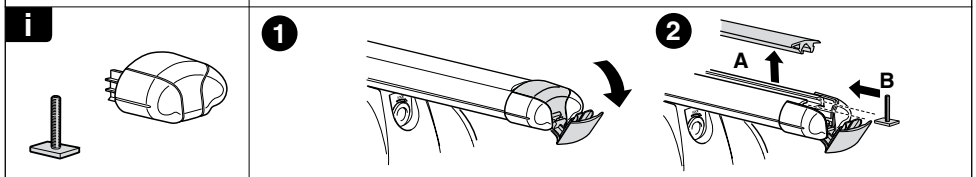
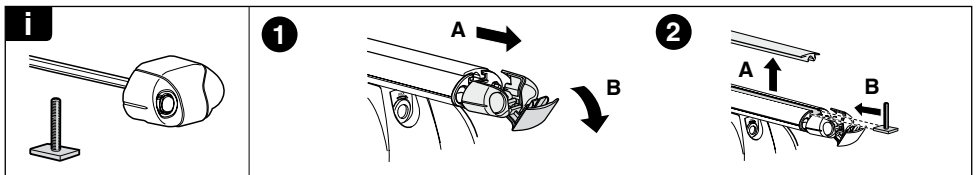
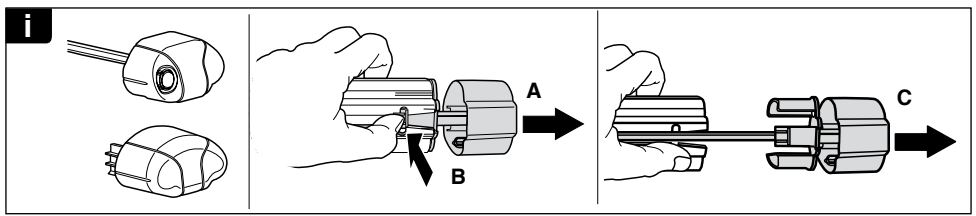
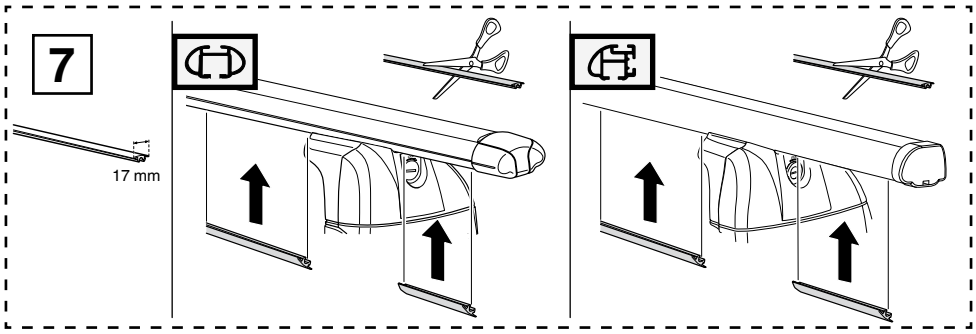

THULE
SWEDEN

**ONE
KEY
SYSTEM**

544 (x4)

596 (x6)

588 (x8)

NA 510 (x10)

EUR 452 (x12)